















TABLE OF CONTENTS

→	VEHICLE KEYS	SECTION 1	
→	NORTH AMERICAN CYLINDER	SECTION 2	
→	INTERNATIONAL CYLINDER	SECTION 3	
→	ORIGINALS	SECTION 4A	
→	LOOK-ALIKE CYLINDERS	SECTION 4B	
→	LOOK-ALIKE REMOTES	SECTION 4C	
→	SAFE DEPOSIT	SECTION 5	
→	FLAT STEEL	SECTION 6A	
→	MISCELLANEOUS	SECTION 6B	
→	BIT AND BARREL	SECTION 7	
→	SPECIALTY KEYS	SECTION 8A	
→	MERCHANDISING AIDS	SECTION 8B	
→	KEY MACHINES	SECTION 9	
→	CROSS REFERENCE	SECTION 10	

This directory contains the latest information available on our line of Key Blanks, Key Machines, and Key Blank Assortments. We have made every attempt to ensure the accuracy of its contents. We believe we have produced a valuable tool if used as intended - as a guide. In the case of Key blank selection, we recommend you continue to check a selected Key Blank against the original Key for blade length, width, shape and milling before duplicating. Kaba Ilco Corp. reserves the right to amend the information contained herein.

Kaba Ilco designs and manufactures replacement key blanks compatible with Original Equipment Manufacturer (OEM) key brands.

Kaba Ilco Corporation is not affiliated with, connected to, associated with, or sponsored by the various OEM key brands displayed. Each OEM brand is a trademark of the respective brand owners and are not manufactured or sold by the respective brand owners.

Ilco® and Ilco EZ® are registered trademarks of Kaba Ilco Corp.

All Rights Reserved

© KABA ILCO CORP 2022

INTRODUCTION

This directory is designed to be a valuable reference tool for the professional locksmith. It contains extensive technical data and actual size drawings of key blanks and milling profiles. The directory is divided into color coded section; each section is organized in alphabetical order by lock manufacturer of application. The sections are as follows:

SECTION 1 - WORLDWIDE VEHICLE

Key blanks; used in vehicles (automobiles, motorcycles, yard tractors, etc.) and applications related to vehicles, such as gas caps, steering wheel locks, toolboxes, etc. This is a worldwide listing. Some of the key blanks in this section will have transponders and are identified with the symbol "🏠".

SECTION 2 - NORTH AMERICAN CYLINDER

Key blanks for residential and commercial applications (including padlocks) that are primarily sold in North America. Lock manufacturers are listed in alphabetical order. Some key blanks may be listed in multiple sections.

SECTION 3 - INTERNATIONAL CYLINDER

Key blanks for residential and commercial applications (including padlocks) that are primarily made and sold in markets other than North America. Lock manufacturers are organized in alphabetical order, Silca and Orion key blank numbers are referenced below the ILCO number.

SECTION 4

4A - ORIGINALS

Through licenses with vehicle manufacturers, we are authorized to offer automotive key blanks with the original manufacturers' logos. This section includes Chrysler, Ford and GM logos.

4B - LOOK-ALIKE CYLINDERS

Key blanks which are made as close to the original as legally possible. These key blanks would meet the industry standards of an original, except they do not carry the original or ILCO logo. These are normally less expensive than original equipment key blanks.

4C - LOOK-ALIKE REMOTES

Look-Alike Remotes maintain the OEM look and functionality for Remote Keyless Entry, Remote Head Keys, Proximity Keys, Flip Keys, etc. at a fraction of the cost. Applications are related to vehicles in North America. All items program into the vehicle the same as the OEM equivalent with either a key programming tool or On Board Programming. Refer to www.ilcolookalike.com for more details on each item.

SECTION 5 - SAFE DEPOSIT

Worldwide listing of key blanks for safe deposit and some safe applications. Safe deposit manufacturers are shown in alphabetical orders.

SECTION 6

6A - FLAT STEEL

Steel and other material key blanks that are used in warded padlocks, gym lockers, yard tractors, etc. They are organized by lock manufacturer where possible and listed in numerical order.

SECTION 6B - MISCELLANEOUS

A selection for special purpose keys such as forklift, clock key, luggage, etc. are shown in this section.

SECTION 7 - BIT AND BARREL

Keys are separated by type (i.e. bit or barrel). Technical data, including material (i.e. malleable iron, b-metallic, brass, etc.) is shown beneath each key illustration..

SECTION 8 - SPECIALTY KEY

An overview of specialty key blanks such as large bow, neuter bow, customer coined, and painted key can be found in this section.

SECTION 9 - KEY MACHINES

A brief description of some of the most popular key machines and equipment offered by ILCO.

SECTION 10 - CROSS REFERENCE

The cross reference lists major lock and replacement key manufacturers in alphabetical order with their key numbers in the appropriate sequence. The ILCO key equivalent is listed beside the original or competitors' key number. This listing is set up as a function cross reference. Certain replacement key manufacturers have been omitted due to laws in their respective countries concerning the publishing or cross reference.

PAGE SET UP

- The manufacturer's name appears above the key blank drawings.
- The ILCO number appears below each key. Vehicle section references the EZ number below the ILCO number.
- International Cylinder section references Silca and Orion key blank numbers below the ILCO number.
- Key drawings may also show important information such as number of pins, the presence of a transponder in the head, etc.

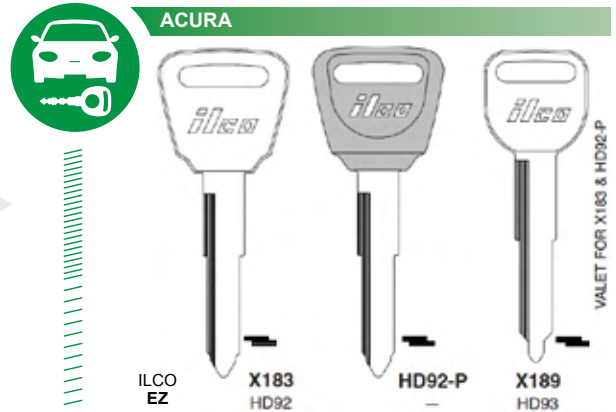

KEY DRAWINGS

Key blank drawings and milling profiles are shown actual size.

Most single side keys are illustrated from the finger side. To determine the finger side, hold the key in the right hand between the thumb and index finger. Be sure the bitted area is facing up. The finger side is held with you index finger.

Where two milling profiles with different head shapes or configurations exist, both versions are shown.

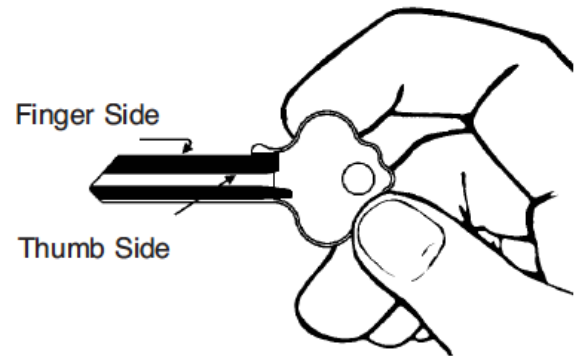

CHECKING MILLING PROFILE

To check the milling profile, hold the key blank by the head and place the tip of the key over the milling profile. Looking straight down, check both sides of the milling profile to be certain of the match.

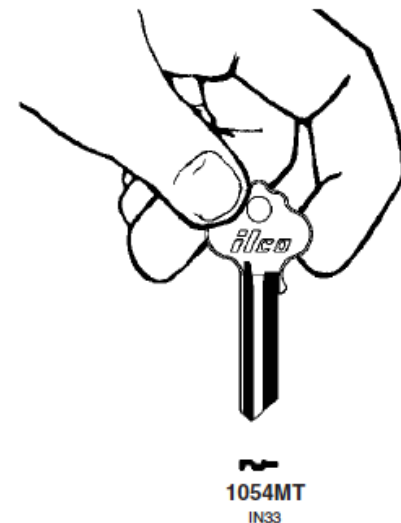

This directory illustrates all of the key blanks currently manufactured by Kaba Ilco Corp. However, we are continuously adding new key blanks to keep up with market demands. We make every effort to keep the market informed of new key blanks, and any updates to this document will be in the format explained above.

This directory includes some key blanks that are made by Silca, a sister division of Kaba Ilco Corp.. These Silca key blanks have no ILCO equivalent, and have been added to our product line to meet the anticipated needs of our many markets.

The ILCO KEY DIRECTORY is a valuable reference document and we welcome your comments on how to improve it in the future.

INTRODUCTION

Ce répertoire a été conçu afin d'être un outil de référence précieux pour les serruriers professionnels. Il contient des données techniques détaillées et des dessins grandeur nature des clés brutes et des profils de fraisage. Le répertoire est divisé en sections à code-couleur ; chaque section est organisée en ordre alphabétique par fabricant de serrure ou application. Les sections sont décrites ci-dessous :

SECTION 1 - VÉHICULES DE PARTOUT DANS LE MONDE

Clés brutes ; utilisées pour des véhicules (automobiles, motocyclettes, tracteurs de manœuvre, etc.) et des applications liées aux véhicules, telles que les couvercles de réservoirs, les dispositifs de blocage du volant, les boîtes à outils, etc. Cette liste a un caractère mondial. Certaines clés brutes de cette section ont des transpondeurs et sont identifiées à l'aide du symbole " ".

SECTION 2 - BARILLET DE SERRURE NORD-AMÉRICAIN

Clés brutes pour applications résidentielles et commerciales (y compris les cadenas) commercialisées principalement en Amérique du Nord. Les fabricants des serrures sont énumérés en ordre alphabétique. Certaines clés brutes peuvent figurer dans plusieurs sections.

SECTION 3 - BARILLET DE SERRURE INTERNATIONALE

Clés brutes pour applications résidentielles et commerciales (y compris les cadenas) fabriquées et commercialisées principalement en dehors de l'Amérique du Nord. Les fabricants des serrures sont énumérés en ordre alphabétique, les numéros des clés brutes Silca et Orion sont mentionnés en référence en-dessous du numéro ILCO.

SECTION 4

4A - ARTICLES D'ORIGINE

En utilisant des licences fournies par les fabricants de véhicules, nous sommes autorisés à produire des clés brutes pour le secteur automobile avec les logos d'origine des fabricants. Cette section comprend des logos Chrysler, Ford et GM.

4B - BARILLETS RESSEMBLANTS LOOK-ALIKE®

Clés brutes fabriquées aussi près de l'original que possible légalement. Ces clés brutes répondent aux normes de l'industrie, tout comme le produit d'origine, mais elles n'ont pas de logo d'origine ou ILCO. Ces clés sont généralement moins chères que les clés brutes d'origine.

4C - TÉLÉCOMMANDES RESSEMBLANTES LOOK-ALIKE®

Les télécommandes ressemblantes ont l'aspect et les fonctionnalités de l'équipement d'origine pour l'Accès sans clé, les Têtes de clés à télécommande, les Clés de proximité, les Clés pliables, etc. à une fraction du coût. Les applications sont associées aux véhicules de l'Amérique du Nord. Tous les articles peuvent être programmés pour un véhicule de la même manière que l'article équivalent d'origine, soit avec un outil de programmation de clé, soit par la programmation à bord. Rendez-vous sur www.ilcolookalike.com pour plus de détails sur chaque article.

SECTION 5 - COFFRE-FORT

Liste globale de clés brutes pour coffres-forts et certaines applications associées. Les fabricants de coffres-forts sont énumérés en ordre alphabétique.

SECTION 6

6A - ACIER PLAT

Clés brutes en acier et autres matériaux utilisés pour cadenas à garniture, vestiaires de gymnase, tracteurs de manœuvre, etc. Elles sont organisées en fonction du fabricant de la serrure, dans la mesure du possible, et énumérées en ordre numérique.

SECTION 6B - DIVERS

Cette section présente une sélection de clés spécialisées, telles que des clés de chariot élévateur, d'horloge, de bagages, etc.

SECTION 7 - PANNETON ET BARILLET

Les clés sont séparées par types (c'est-à-dire panneton ou barillet). Les données techniques, y compris le matériau (c'est-à-dire fonte malléable, alliage de laiton, etc.) sont affichées en-dessous de chaque image de clé.

SECTION 8 - CLÉS SPÉCIALISÉES

Cette section présente une vue d'ensemble des clés brutes spécialisées, telles que les clés à tête grande, à tête neutre, personnalisées pour les clients et peintes.

SECTION 9 - COPIEURS DE CLÉS

Une courte description de quelques copieurs de clés populaires et d'autres équipements fournis par ILCO.

SECTION 10 - RÉFÉRENCE CROISÉE

La référence croisée énumère les principaux fabricants de serrures et clés de remplacement en ordre alphabétique, avec les numéros des clés dans l'ordre approprié. La clé ILCO équivalente est indiquée à côté du numéro de la clé originale ou du produit d'un concurrent. Cette liste est organisée pour servir de référence croisée. Certains fabricants de clés de remplacement ont été omis, en raison des lois dans leurs pays d'origine concernant la publication ou les références croisées.

MISE EN PAGE

- Le nom du fabricant figure en-dessus du dessin de la clé brute.
- Le numéro ILCO figure en-dessous de chaque clé. La section des véhicules mentionne le numéro EZ en-dessous du numéro ILCO.
- La section Barillet International mentionne les numéros des clés brutes Silca et Orion en-dessous du numéro ILCO.
- Les dessins des clés peuvent aussi transmettre des informations importantes, telles que le nombre de broches, la présence d'un transpondeur dans la tête, etc.

DESSINS DES CLÉS

Les dessins des clés et les profils de fraisage sont illustrés grandeur nature.

Pour la plupart, les clés à un seul côté sont illustrées du côté de l'index. Pour savoir quel est le côté de l'index, saisissez la clé dans la main droite entre le pouce et l'index. Assurez-vous que le côté à pannetons est orienté vers le haut. Votre index indique le côté de l'index.

S'il y a deux profils de fraisage avec des têtes de formes différentes ou des configurations différentes, les deux versions sont illustrées.

VÉRIFICATION DU PROFIL DE FRAISAGE

Pour vérifier le profil de fraisage, saisissez la clé brute par la tête et mettez la pointe de la clé en-dessus du profil de fraisage. En regardant directement vers le bas, vérifiez les deux côtés du profil de fraisage pour être sûr de la correspondance.

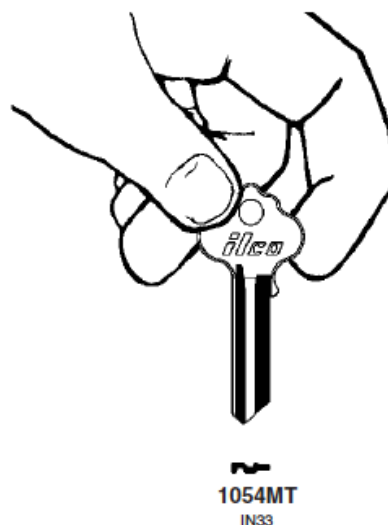
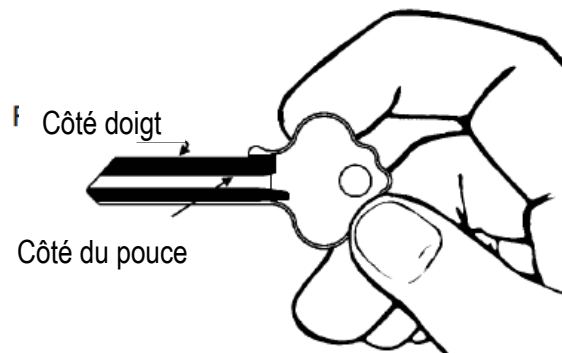
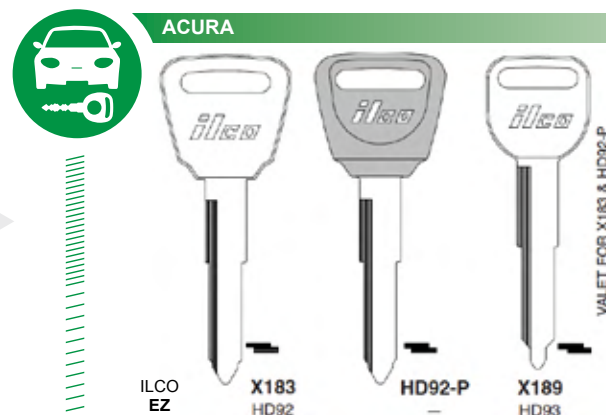

Ce répertoire illustre toutes les clés brutes actuellement fabriquées par Kaba Ilco Corp. ; Cependant, nous ajoutons constamment de nouvelles ébauches de clés pour répondre aux demandes du marché. Nous nous efforçons de tenir le marché informé des nouvelles ébauches de clé, et toutes les mises à jour de ce document seront dans le format expliqué ci-dessus.

Ce répertoire comprend des ébauches de clés fabriquées par Silca, une division sœur de Kaba Ilco Corp. Ces ébauches de clés Silca n'ont pas d'équivalent ILCO et ont été ajoutées à notre gamme de produits pour répondre aux besoins anticipés de nos nombreux marchés.

Le RÉPERTOIRE DE CLÉS ILCO est un document de référence précieux et nous apprécions vos commentaires sur la manière de l'améliorer à l'avenir.

INTRODUCCIÓN

Este directorio está diseñado para ser una valiosa herramienta de referencia para el cerrajero profesional. Contiene datos técnicos detallados y dibujos dimensionales reales de llaves en bruto y perfiles de fresado. El directorio está dividido en secciones codificadas por colores; cada sección está organizada alfabéticamente por fabricante de cerradura o aplicación. Las secciones son las siguientes:

PISTA

Hay dos índices en este documento de referencia. El primero consiste en los números vacíos de la clave ILCO. Se enumeran en orden alfabético numérico con la sección y las páginas en las que se muestran. El segundo es un índice de las marcas de los fabricantes y las aplicaciones de bloqueo. Las teclas en blanco correspondientes a estas marcas se pueden encontrar en las páginas indicadas.

SECCIÓN 1 - VEHÍCULOS EN TODO EL MUNDO

Llaves en blanco; se utilizan en vehículos (automóviles, motocicletas, tractores de jardín, etc.) y aplicaciones relacionadas con los vehículos, como tapas de gasolina, seguros de volante, cajas de herramientas, etc. Esta es una lista mundial. Algunas de las llaves en blanco de esta sección tendrán transpondedores y están identificadas con el símbolo “”.

SECCIÓN 2 - CILINDROS DE AMÉRICA DEL NORTE

Llaves en blanco para aplicaciones residenciales y comerciales (incluidos candados) que se venden principalmente en América del Norte. Los fabricantes de cerraduras se enumeran en orden alfabético. Algunas llaves en blanco pueden estar en las listas de varias secciones.

SECCIÓN 3 - CILINDROS INTERNACIONALES

Llaves en blanco para aplicaciones residenciales y comerciales (incluidos candados) que se fabrican y venden principalmente en mercados distintos de América del Norte. Los fabricantes de cerraduras están organizados en orden alfabético, los números en blanco de las llaves Silca y Orion se indican debajo del número ILCO.

SECCIÓN 4

4A - ORIGINALES

A través de licencias con los fabricantes de vehículos, estamos autorizados para ofrecer llaves en blanco para automóviles con los logotipos originales de los fabricantes. Esta sección incluye los logotipos de Chrysler, Ford y GM.

4B - CILINDROS SIMILARES

Llaves en blanco que se hacen tan parecidas a las originales como sea legalmente posible. Estas llaves en blanco cumplirían con los estándares de la industria de una llave original, excepto que no llevan el logotipo original o de ILCO. Estas llaves son normalmente menos costosas que las llaves en blanco del equipo original.

4C - CONTROLES REMOTOS SIMILARES

Los controles remotos similares mantienen el aspecto y la funcionalidad del fabricante original del producto para la entrada sin llave por control remoto, las llaves con control remoto para auto, las llaves de proximidad, las llaves plegables, etc. a una fracción del costo. Las aplicaciones están relacionadas con los vehículos en América del Norte. Todos los artículos se programan en el vehículo de la misma manera que lo hace el fabricante original del producto con una herramienta de programación de llaves o programación para reconocimiento de llaves. Consulte www.ilcolookalike.com para obtener más detalles sobre cada artículo.

SECCIÓN 5 - CAJAS DE DEPÓSITOS DE SEGURIDAD

Lista mundial de llaves en blanco para cajas de depósitos de seguridad y algunas aplicaciones de seguridad. Los fabricantes de cajas de depósitos de seguridad se muestran en orden alfabético.

SECCIÓN 6

6A - PLACAS DE ACERO PLANAS

Se utiliza acero y otros materiales para la fabricación de llaves en blanco para candados de protección, casilleros de gimnasios, tractores de jardín, etc. Siempre que es posible, se organizan por fabricante de cerraduras y se indican en listas en orden numérico.

SECCIÓN 6B - USOS DIVERSOS

En esta sección se muestra una selección de llaves para usos especiales, como llaves de montacargas, llaves de reloj, llaves de equipaje, etc.

SECCIÓN 7 - LLAVES SÓLIDAS Y LLAVES HUECAS

Las llaves están separadas por tipo (es decir, sólidas y huecas). Los datos técnicos, incluido el material (es decir, hierro maleable, b-metálico, latón, etc.) se muestran debajo de cada ilustración de las llaves.

SECCIÓN 8 - LLAVES ESPECIALES

En esta sección se puede encontrar una descripción general de las llaves en blanco especiales, como llaves de cabeza grande, cabeza neutra, acuñadas por el cliente y llaves pintadas.

SECCIÓN 9 - MÁQUINAS DE LLAVES

Una breve descripción de algunas de las máquinas y equipos para llaves más populares que ofrece ILCO.

SECCIÓN 10 - REFERENCIA CRUZADA

La referencia cruzada enumera los principales fabricantes de cerraduras y llaves de reemplazo en orden alfabético con sus números de llave en la secuencia adecuada. El equivalente de la llave ILCO se encuentra junto al número de llave original o de la competencia. Esta lista se establece como una función de referencia cruzada. Ciertos fabricantes de llaves de repuesto se han omitido debido a las leyes de sus respectivos países con respecto a la publicación o la referencia cruzada.

CONFIGURACIÓN DE PÁGINA

- El nombre del fabricante aparece encima de los dibujos de las llaves en blanco.
- El número ILCO aparece debajo de cada llave. La sección de vehículos hace referencia al número EZ debajo del número ILCO.
- La sección de cilindros internacionales hace referencia a los números de las llaves en blanco de Silca y Orion debajo del número ILCO.
- Los dibujos de las llaves también pueden mostrar información importante, como el número de dientes, la presencia de un transpondedor en la cabeza, etc.

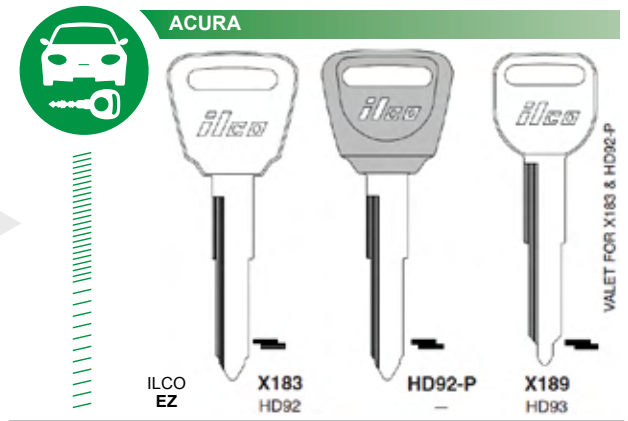

DIBUJOS DE LLAVES

Los dibujos de llaves en blanco y los perfiles de fresado se muestran en tamaño real.

La mayoría de las llaves de un solo lado se ilustran desde el lado del dedo. Para determinar el lado del dedo, sostenga la llave en la mano derecha entre el pulgar y el índice. Asegúrese de que el área dentada esté hacia arriba. El lado del dedo se sujeta con el dedo índice.

Cuando existen dos perfiles de fresado con diferentes formas o configuraciones de cabeza, se muestran ambas versiones.

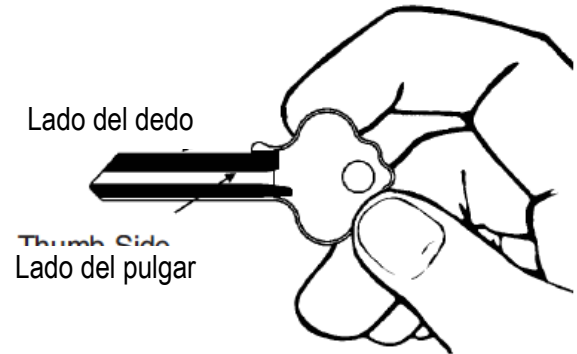

VERIFICACIÓN DEL PERFIL DE FRESADO

Para verificar el perfil de fresado, sostenga la llave en blanco por la cabeza y coloque la punta de la llave sobre el perfil de fresado. Mirando directamente hacia abajo, verifique ambos lados del perfil de fresado para asegurarse de que coincidan.

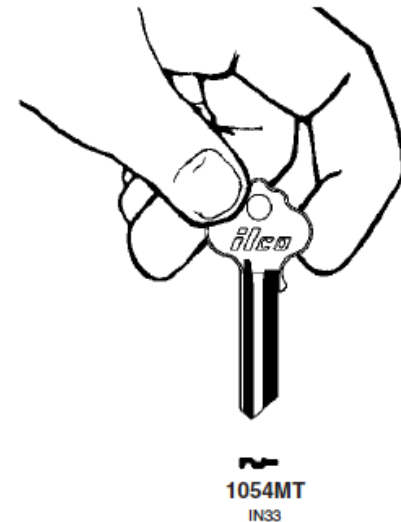

Este directorio ilustra todas las llaves en blanco fabricadas actualmente por Kaba Ilco Corp.; Sin embargo, constantemente agregamos nuevas llaves en bruto para satisfacer las demandas del mercado. Hacemos todo lo posible para mantener informado al mercado de los nuevos borradores clave, y todas las actualizaciones de este documento estarán en el formato explicado anteriormente.

Este directorio incluye llaves en bruto fabricadas por Silca, una división hermana de Kaba Ilco Corp. Estas llaves en bruto Silca no tienen un equivalente ILCO y se han agregado a nuestra línea de productos para satisfacer las necesidades anticipadas de nuestros numerosos mercados.

EL DIRECTORIO CLAVE DE ILCO es un documento de referencia valioso y agradecemos sus comentarios sobre cómo mejorarlo en el futuro.



INDEX

The following Key Blank location index has been prepared to assist you in locating a key blank. Key Blank location is designated by section and page number. In the case of multiple listings for the same key blank, each location is shown.

ILCO Number	Sec - Page(s)	ILCO Number	Sec - Page(s)	ILCO Number	Sec - Page(s)	ILCO Number	Sec - Page(s)
FLIP-ACURA-3B1	4-312	POD-LAL-4B6	4-316	PRX-CHRY-3B2	4-314	PRX-LEX-4B4	4-339
FLIP-ACURA-4B1	4-312	POD-LAL-4B7	4-335	PRX-CHRY-3B3	4-317,	PRX-LEX-4B5	4-340
FLIP-ACURA-4B2	4-312	POD-LAL-4B8	4-316		4-336	PRX-LEX-4B6	4-340
FLIP-ACURA-4B3	4-312	POD-LAL-4B9	4-316,	PRX-CHRY-3B4	4-314,	PRX-NIS-3B2	4-344
FLIP-FIAT-3B1	4-319		4-335		4-317	PRX-NIS-3B3	4-344
FLIP-FIAT-3B2	4-319	POD-LAL-4B10	4-336	PRX-CHRY-4B4	4-317,	PRX-NIS-3B4	4-344
FLIP-FORD-3B1HS	4-319	POD-LAL-5B1	4-313,		4-336	PRX-NIS-3B5	4-345
FLIP-FORD-4B2HS	4-319		4-317,	PRX-CHRY-4B5	4-317,	PRX-NIS-3B6	4-345
FLIP-FORD-4B3HS	4-320	POD-LAL-5B2	4-314,		4-336	PRX-NIS-4B1	4-335,
FLIP-GM-3B1HS	4-321		4-317,	PRX-CHRY-4B6	4-314,		4-345
FLIP-GM-4B1HS	4-321		4-355		4-318	PRX-NIS-4B10	4-345
FLIP-GM-4B2HS	4-322	POD-LAL-5B3	4-336	PRX-CHRY-5B3	4-314	PRX-NIS-4B11	4-345
FLIP-GM-4B3HS	4-322	POD-LAL-5B4	4-336	PRX-CHRY-5B4	4-318,	PRX-NIS-4B12	4-345
FLIP-GM-4B4HS	4-322	POD-LAL-5B6	4-317		4-336	PRX-NIS-4B2	4-345
FLIP-GM-5B1HS	4-322	POD-LAL-5B7	4-336	PRX-CHRY-5B5	4-314,	PRX-NIS-4B3	4-345
FLIP-GM-5B2HS	4-322	POD-LAL-5B8	4-336		4-318	PRX-NIS-4B7	4-345
FLIP-HON-3B2	4-312	POD-LAL-5B9	4-314	PRX-CHRY-6B1	4-314	PRX-NIS-4B8	4-345
FLIP-HYUN-4B3	4-334		4-315	PRX-CHRY-6B2	4-315	PRX-NIS-4B9	4-345
FLIP-HYUN-4B4	4-334	POD-LAL-6B1	4-314,	PRX-CHRY-7B1	4-315	PRX-NIS-5B3	4-345
FLIP-JAG-4B1	4-335		4-317,	PRX-FORD-3B2	4-320	PRX-NIS-5B4	4-346
FLIP-KIA-3B1	4-338		4-355	PRX-FORD-3B3	4-320	PRX-NIS-5B5	4-346
FLIP-KIA-3B2	4-338	POD-LAL-6B2	4-336	PRX-FORD-4B2	4-320	PRX-NIS-5B6	4-346
FLIP-KIA-3B3	4-338	POD-LAL-6B3	4-336	PRX-FORD-4B3	4-320	PRX-NIS-5B7	4-346
FLIP-KIA-4B3	4-338	POD-LAL-6B4	4-314,	PRX-FORD-4B4	4-320,	PRX-NIS-5B8	4-346
FLIP-KIA-4B4	4-339		4-317		4-341	PRX-NIS-5B9	4-346
FLIP-KIA-4B5	4-339	POD-LAL-7B1	4-314,	PRX-FORD-5B2	4-320,	PRX-NIS-5B10	4-346
FLIP-KIA-4B6	4-339		4-317,		4-341	PRX-RAM-3B1	4-347
FLIP-KIA-4B7	4-339		4-355	PRX-FORD-5B4	4-320	PRX-RAM-4B1	4-348
FLIP-MAZ-3B1	4-342	POD-LAL-7B2	4-314,	PRX-FORD-5B5	4-320,	PRX-RAM-5B1	4-348
FLIP-MAZ-3B2	4-342		4-317		4-320	PRX-NIS-5B10	4-346
FLIP-MAZ-4B1	4-342	PRX-BMW-3B1	4-313	PRX-FORD-5B6	4-320,	PRX-TOY-3B2	4-349
FLIP-MAZ-4B2	4-342	PRX-BMW-3B3	4-313		4-341	PRX-TOY-3B3	4-349
FLIP-NIS-3B2	4-344	PRX-BMW-4B1	4-313	PRX-FORD-5B7	4-320	PRX-TOY-3B4	4-350
FLIP-PROMASTER-3B1	4-347	PRX-BMW-4B2	4-313	PRX-FORD-5B8	4-320,	PRX-TOY-3B5	4-350
		PRX-BMW-4B3	4-313		4-341	PRX-TOY-3B6	4-350
FLIP-PROMASTERCITY-3B1	4-347	PRX-BMW-4B4	4-313	PRX-FORD-5BP	4-321	PRX-TOY-3B7	4-350
		PRX-BUICK-3B1	4-323	PRX-GM-3B1	4-325	PRX-TOY-3B8	4-350
FLIP-TOY-3B1	4-349	PRX-BUICK-3B2	4-323	PRX-GM-3B2	4-325	PRX-TOY-3B9	4-350
FLIP-TOY-4B1	4-349	PRX-BUICK-4B1	4-323	PRX-GM-4B1	4-326	PRX-TOY-3B10	4-350
FLIP-VW-4B1	4-354	PRX-BUICK-4B2	4-323	PRX-GM-4B3	4-326	PRX-TOY-4B2	4-350
GM-A	4-311	PRX-BUICK-5B1	4-323	PRX-GM-4B4	4-326	PRX-TOY-4B3	4-350
GM-B	4-311	PRX-BUICK-5B2	4-323	PRX-GM-5B1	4-326	PRX-TOY-4B4	4-350
GM-C	4-311	PRX-BUICK-5B3	4-323	PRX-GM-5B6	4-326	PRX-TOY-4B5	4-350
GM-D	4-311	PRX-CAD-3B1	4-324	PRX-GM-5B7	4-326	PRX-TOY-4B6	4-350
GM-E	4-311	PRX-CAD-3B2	4-324	PRX-GM-6B2	4-326	PRX-TOY-4B7	4-351
GM-H	4-311	PRX-CAD-4B1	4-324	PRX-HYUN-4B2	4-334,	PRX-TOY-4B8	4-351
GM-J	4-311	PRX-CAD-4B2	4-324		4-339	PRX-TOY-4B9	4-351
GM-K	4-311	PRX-CAD-4B3	4-324	PRX-HYUN-4B3	4-334,	PRX-TOY-4B10	4-351
POD-LAL-3B1	4-313,	PRX-CAD-5B1	4-324		4-339	PRX-TOY-4B11	4-351
	4-316,	PRX-CAD-5B2	4-324	PRX-HYUN-4B4	4-334	PRX-TOY-4B12	4-351
	4-335	PRX-CAD-5B3	4-324	PRX-INF-4B1	4-334	RHK-BMW-3B1	4-313,
	4-346,	PRX-CAD-5B4	4-324	PRX-INF-4B2	4-334		4-348
	4-353	PRX-CAD-5B5	4-324	PRX-INF-5B1	4-335	RHK-BMW-3B2	4-313,
POD-LAL-3B2	4-346	PRX-CAD-6B1	4-324	PRX-JEEP-3B1	4-336		4-348
POD-LAL-3B3	4-334	PRX-CAD-6B2	4-324	PRX-JEEP-3B2	4-337	RHK-CHRY-3B1	4-315,
POD-LAL-3B4	4-316,	PRX-CHEVY-3B1	4-325	PRX-JEEP-3B3	4-337		4-318,
	4-335	PRX-CHEVY-3B2	4-325	PRX-JEEP-4B1	4-337		4-337
POD-LAL-4B1	4-313,	PRX-CHEVY-4B1	4-325	PRX-JEEP-4B2	4-337	RHK-CHRY-3B2	4-318,
	4-316	PRX-CHEVY-4B2	4-325	PRX-JEEP-4B3	4-337		4-343
POD-LAL-4B2	4-313,	PRX-CHEVY-5B1	4-325	PRX-JEEP-4B4	4-337	RHK-CHRY-3B3	4-315,
	4-316,	PRX-CHEVY-5B2	4-325	PRX-JEEP-4B5	4-337		4-318
	4-346	PRX-CHEVY-5B3	4-325	PRX-JEEP-5B1	4-337	RHK-CHRY-4B1	4-315,
POD-LAL-4B3	4-335	PRX-CHEVY-5B4	4-325	PRX-LEX-3B1	4-339		4-318,
POD-LAL-4B4	4-347	PRX-CHEVY-5B5	4-325	PRX-LEX-4B2	4-339		4-337,
POD-LAL-4B5	4-347	PRX-CHEVY-6B1	4-325	PRX-LEX-4B3	4-339		4-348

ILCO Number	Sec - Page(s)	ILCO Number	Sec - Page(s)	ILCO Number	Sec - Page(s)	ILCO Number	Sec - Page(s)
RHK-CHRY-4B2	4-315, 4-318, 4-337, 4-347	RHK-MITS-3B2	4-343	RKE-FORD-5B3	4-322, 4-342, 4-343	RKE-MAZ-3B2	4-342
RHK-CHRY-4B3	4-315, 4-318	RHK-MITS-4B1	4-343			RKE-MAZ-4B1	4-342
RHK-CHRY-4B4	4-315, 4-338	RHK-MITS-4B2	4-344	RKE-GM-3B1	4-326	RKE-MAZ-4B2	4-342
RHK-CHRY-4B5	4-315, 4-318, 4-338, 4-348	RHK-NIS-3B1	4-335, 4-346	RKE-GM-3B2	4-327	RKE-MITS-2B1	4-344
RHK-CHRY-5B1	4-315, 4-319, 4-338	RHK-NIS-4B1	4-335	RKE-GM-3B3	4-327	RKE-MITS-2B2	4-344
RHK-CHRY-5B2	4-316, 4-319, 4-338	RHK-NIS-4B2	4-335, 4-346	RKE-GM-3B4	4-327	RKE-MITS-2B3	4-344
RHK-CHRY-6B1	4-316, 4-321	RHK-SUB-4B1	4-348	RKE-GM-3B5	4-327	RKE-MITS-3B1	4-344
RHK-FORD-3B1	4-321	RHK-SUB-4B2	4-349	RKE-GM-3B6	4-327	RKE-MITS-3B2	4-344
RHK-FORD-3B3HS	4-321	RHK-SUB-4B3	4-349	RKE-GM-3B7	4-327	RKE-MITS-3B3	4-344
RHK-FORD-3B4	4-321	RHK-SUB-4B4	4-349	RKE-GM-3B8	4-327	RKE-MITS-4B1	4-344
RHK-FORD-3B5	4-321	RHK-SUB-4B5	4-349	RKE-GM-3B9	4-327	RKE-NIS-3B1	4-346
RHK-FORD-3B6HS	4-321	RHK-SUB-4B6HS	4-349	RKE-GM-4B1	4-327	RKE-NIS-4B1	4-346
RHK-FORD-3B7HS	4-321	RHK-TOY-3BD1	4-351	RKE-GM-4B10	4-328	RKE-NIS-5B1	4-346
RHK-FORD-4B1HS	4-321	RHK-TOY-3BD2	4-351	RKE-GM-4B11	4-328	RKE-NIS-6B1	4-347
RHK-FORD-4B2	4-321, 4-341	RHK-TOY-3BD3	4-351	RKE-GM-4B12	4-328	RKE-SUB-2B1	4-349
RHK-FORD-4B3	4-322, 4-341	RHK-TOY-3BFJ	4-351	RKE-GM-4B13	4-328	RKE-SUB-4B1	4-349
RHK-FORD-4B4	4-322, 4-341	RHK-TOY-3BFJ2	4-351	RKE-GM-4B14	4-328	RKE-SUB-4B2	4-349
RHK-FORD-5B1	4-322, 4-341	RHK-TOY-3BG1	4-352	RKE-GM-4B15	4-328	RKE-TOY-3B1	4-353
RHK-FORD-3B1	4-342	RHK-TOY-3BG2	4-352	RKE-GM-4B16	4-328	RKE-TOY-3B2	4-353
RHK-FORD-4B1	4-343	RHK-TOY-3BG3	4-352	RKE-GM-4B17	4-328	RKE-TOY-3B3	4-331, 4-354
RHK-HON-3B1	4-331	RHK-TOY-3BH	4-352	RKE-GM-4B18	4-328	RKE-TOY-3B4	4-348, 4-354
RHK-HON-3B2	4-331	RHK-TOY-3BH2	4-352	RKE-GM-4B19	4-329		
RHK-HON-3B4	4-331	RHK-TOY-3BH3	4-352	RKE-GM-4B2	4-329	RKE-TOY-4B1	4-354
RHK-HON-3B5	4-331	RHK-TOY-3BLC	4-352	RKE-GM-4B20	4-329	RKE-TOY-4B2	4-354
RHK-HON-3B6	4-332	RHK-TOY-3BLC	4-352	RKE-GM-4B21	4-329	RKE-TOY-4B3	4-354
RHK-HON-3B7	4-332	RHK-TOY-3BPC	4-352	RKE-GM-4B22	4-329	RKE-TOY-4B4	4-354
RHK-HON-3B8	4-332	RHK-TOY-4B1	4-352	RKE-GM-4B3	4-329	RKE-TOY-4B5	4-354
RHK-HON-4B1	4-332	RHK-TOY-4BD	4-353	RKE-GM-4B4	4-329	RKE-TOY-4B6	4-331, 4-354
RHK-HON-4B10	4-332	RHK-TOY-4BD2	4-353	RKE-GM-4B5	4-329		
RHK-HON-4B2	4-332	RHK-TOY-4BG	4-353	RKE-GM-4B6	4-329	RKE-TOY-5B1	4-354
RHK-HON-4B3	4-332	RHK-TOY-4BG2	4-353	RKE-GM-4B7	4-330	RKE-TOY-6B1	4-354
RHK-HON-4B4	4-332	RHK-TOY-4BH	4-353	RKE-GM-4B8	4-330	RSK-VW-4B1	4-355
RHK-HON-4B6	4-312, 4-332	RHK-TOY-4BH2	4-353	RKE-GM-4B9	4-330	1B	7-377
RHK-HON-4B7	4-332	RHK-TOY-4BH3	4-353	RKE-GM-5B1	4-330	1K	4-308
RHK-HON-4B8	4-332	RKE-ACURA-3B1	4-312	RKE-GM-5B2	4-330	1A1A1	4-307
RHK-HON-4B9	4-332	RKE-ACURA-3B2	4-312	RKE-GM-5B3	4-330	1A1B1	4-307
RHK-HON-5B1	4-333	RKE-ACURA-4B1	4-312	RKE-GM-5B4	4-330	1A1C1	4-307
RHK-HON-6B1	4-333	RKE-ACURA-4B2	4-312	RKE-GM-5B5	4-330	1A1D1	4-307
RHK-LEXUS-3B1	4-340	RKE-CAD-4B1	4-326	RKE-GM-5B6	4-330	1A1DD1	4-307
RHK-LEXUS-3B2	4-340	RKE-CAD-4B2	4-326	RKE-GM-5B7	4-331	1A1E1	4-307
RHK-LEXUS-3B3	4-340	RKE-CAD-5B2	4-326	RKE-GM-6B1	4-331	1A1F1	4-307
RHK-LEXUS-3B4	4-340	RKE-CAD-6B1	4-326	RKE-GM-6B2	4-331	1A1FM1	4-307
RHK-LEXUS-3B5	4-340	RKE-CHRY-3B1	4-316, 4-319, 4-347, 4-348	RKE-GM-6B3	4-331	1A1G1	4-307
RHK-LEXUS-3B6	4-340			RKE-HON-3B1	4-333	1A1H1	4-307
RHK-LEXUS-3B7	4-340	RKE-CHRY-3B2	4-319, 4-348	RKE-HON-3B2	4-333	1A1J1	4-307
RHK-LEXUS-3B8	4-340	RKE-CHRY-4B1	4-316, 4-319, 4-338	RKE-HON-3B3	4-333	1A1K1	4-307
RHK-MITS-3B1	4-343			RKE-HON-3B4	4-333	1A1L1	4-307
		RKE-CHRY-4B2	4-316, 4-319	RKE-HON-4B1	4-312, 4-333	1A1M1	4-307
				RKE-HON-4B2	4-333	1A1Q1	4-307
				RKE-HON-4B3	4-333	1A1R1	4-307
				RKE-HON-4B4	4-333	1A1T1	4-307
				RKE-HON-4B5	4-312	1A1WA1	4-307
				RKE-HON-5B1	4-333	1A1WB1	4-307
				RKE-HON-6B1	4-333	1A1WC1	4-307
				RKE-HYUN-3B1	4-334	1A1WD1	4-307
				RKE-HYUN-3B2	4-334	1A1WE1	4-307
				RKE-HYUN-3B3	4-334	1A1WG1	4-307
				RKE-HYUN-4B1	4-334	1A1WH1	4-307
				RKE-HYUN-4B2	4-334	1A1WY1	4-307
				RKE-JEEP-3B1	4-338	A1	2-256
				RKE-KIA-3B1	4-339	AB1	3-285, 3-29
				RKE-KIA-4B1	4-339	AD1	1-44, 1-160, 1-200
				RKE-MAZ-3B1	4-342		

INDEX

ILCO Number	Sec - Page(s)	ILCO Number	Sec - Page(s)	ILCO Number	Sec - Page(s)	ILCO Number	Sec - Page(s)
AF1	2-217	EC1	3-292		2-256	SAA1-P	1-178
AG1	3-285	EE1	3-292	KW1-PC	2-234,	SB1	1-177
AK1	3-285,	EL1	2-235		2-247,	SC1	2-236,
	3-297	ER1	2-235,		2-256		2-269
AL1-BLK	3-284		2-257	KW1-BIG	2-247	SC1-BIG	2-269
AM1	2-216	ES1	1-70	KYM1P-SI	1-135	SC1-PC	2-269
AR1	2-215,	ES1R	1-70	KYM1RP-SI	1-135	SE1	2-270
	2-217	EV1	2-236	L1	2-248	SE1B	1-180
AR1-PC	2-215,	EX1	2-238,	LA1	1-136,	SE1C	1-180
	2-217		3-299		1-165	SJ1	1-184
AR1SC	2-217	EZ1	2-238	LB1	5-358	SK1	2-270
AS1	3-286	FA1	2-237	LD1	2-248	SL1	2-271
AT1	3-288	FB1	1-182	LF1	3-296	SM1	1-63
AUS1	3-289	FF1	1-87	LH1	3-295	SP1	1-40, 1-71
AZ1R-SI	3-289	FIC1	2-238	LK1	3-295	SR1	1-176
B1	1-52, 1-70,	FL1	2-236	LO1	2-246,	SUB1	1-185
	1-91,	FS1	1-38, 1-71		2-249	SUB1-3B	1-186
	1-141,	FV1	1-69,	LU1	6B-373	SUB1FB	1-186
	1-151		1-123,	LUV1	1-94, 1-103	SUB1-GTK	1-186
BAU1	2-218		1-140,	LWC1	3-295	SUB1-P	1-185
BAU1R	2-218		1-143,	M1	2-238,	SUZ1	1-187
BH1	1-140		1-191,		2-249	SW1	3-299
BS1	3-290		1-199	M1-PC	2-249	SY1	5-362
BKZ1	1-200,	GC1	1-91	MAS1	1-142	SZ1	1-124
	3-289	GH1	1-190	ME1	3-297	T1	2-271
BM1	1-135	GL1	3-293	MG1	1-52,	TA1	1-191
BMW1	1-47	GT1	1-137		1-125,	TBE1T5	1-127
BN1	2-218	HAW1	2-240		1-198	TE1	3-300
BO1	2-219,	HD1	1-109	MIT1	1-61, 1-152	TH1-P	1-84
	2-241	HF1	1-147	MIT1-P (-PC)	1-61, 1-152	TM1	2-272
BT1	3-289	HL1	3-293	MN1	5-359	TMC1	1-43, 1-49,
BU1	1-66, 1-87,	HO1	2-220	MR1	2-252		1-54, 1-55,
	1-161	HO01-EMER	1-108	MZ1	1-143		1-70,
CB1	2-225	HO01FB	1-108	N1	2-255		1-125,
CC1	1-103,	HO01-PT	1-108	NA1	2-253		1-135,
	2-223	HO01-SVC	1-108	NE1	1-156		1-142,
CE1	3-288	HO01T5	1-108	NH1	2-215,		1-156,
CG1	1-70,	HOD1	1-105		2-252,		1-168,
	1-128,	HOV01T5	1-108		2-254		1-197
	1-160	HR1	2-240	NI01FB	1-159,	TP1	1-191
CG1P-SI	1-55	HS1	3-293		1-160	TR1	1-71
CH1C	2-217	HYD1	1-104	NI01T	1-123	TT1	1-191
CH1D	2-217	IGS1	3-294	NL1	1-172	TY1	2-271
CL1	2-223	ID1	2-242	OPB1	1-161	UCM1	3-294,
CLB1	1-65	IL1	2-245	ORD1	3-298		3-300
CLP1	2-246	ILL1	2-245	P1	2-256	UN1	1-198
CO1	2-226	IN1	2-243	PA1	1-164	VA1	3-301
CS1	3-288	IS1	2-242	PE1	1-47	VL1	1-205
DB1	1-197	IV1	1-125	PN1	1-91	VR1	3-301
DC1	1-60, 1-97,	K1	2-246	PR1	1-44, 1-67	VS1	1-199
	1-124,	KA1	1-128	PTKB1	4-305	VW1	1-87,
	1-151,	KAB1	3-294	PU1	2-256		1-147,
	1-187	KB1	2-247	PZ1	3-297		1-200
DC1-P	1-60, 1-97,	KFV1	3-293	RD1	3-298	VW1CZ	1-200
	1-124,	KK1	1-131	RA1	1-42	W1	2-274
	1-152,	KK1-P	1-131	RE1	2-257	WAR1	1-207
	1-187	KL1	1-40, 1-147	RL1	3-298	WB1	1-53
DE1	2-232	KM1	1-165	RO1	2-241,	WE1	2-273
DH1	1-69	KP1	1-170,		2-253	WK1	2-273
DO1	2-234		1-200	RU1	2-257	WN1	2-274
DO1M	3-291	KS1	1-47	RV1	1-75	WO1	3-301
DO1S	1-199	KT1	1-134	S1	2-267,	WS1	1-71
DP1	1-173	KW1	2-234,		3-299	WT1	1-67
DT1	1-157		2-236,	SA1	2-262	WTP1	2-274
EA1	2-234		2-247,	SAA1	1-178	X1	1-143,

ILCO Number	Sec - Page(s)	ILCO Number	Sec - Page(s)	ILCO Number	Sec - Page(s)	ILCO Number	Sec - Page(s)
XPA1	1-157, 1-186	FF2	1-91	PN2	1-92	3S-5332	7-382
Y1	3-297	FL2	2-236	PU2	2-256	A3	2-256
Y1E	2-215, 2-279	FR2	2-238	PZ2	3-297	AA3	1-53, 1-125
Y1-PC	2-279	FU2	1-151	RA2	1-42	AB3	3-284
	2-279	GE2	1-172	RD2	3-298	AL3	1-40, 1-71
	2-215, 2-279, 3-289, 3-291, 3-298	GH2	1-190	RL2	3-298	ALP3	3-285
YH1	2-207	GL2	3-293	RU2	2-262	AM3	2-216
YM1	1-147	GT2	1-70, 1-137	S2	2-267, 3-299	AM3L	2-216
YS1	1-88, 1-161	HAW2	2-240	SB2	1-177	AP3	2-221
Z1	1-155, 1-211	HD2	1-109	SE2	2-270	AS3	3-286
	1-211	HR2	2-240, 2-246	SE2B	1-180	B3	1-51, 1-93, 1-103
YU1	1-211	HU2	3-294	SE2C	1-180	BAU3	2-218
ZKN1R	3-302	HY2	1-115, 1-152	SG2	3-299	BMW3	1-48
2B	7-377	HY2-P	1-115, 1-152	SIM2	3-299	BMW3-P	1-48
A2	2-256	HYD2	1-104	SJ2	1-184	BU3	1-92
AA2	1-44, 1-46, 1-53, 1-105, 1-126	ILL2	2-245	SM2	1-63	BT3	3-289
AG2	3-285	IN2	2-242	SP2	1-40, 1-71, 1-141	CA3	1-147
AK2	3-285, 3-297	ISP2	2-242	SR2	1-176	CB3	2-225
AP2	2-221	JA2	1-104	SUB2	1-185	CE3	1-46, 1-198
AT2	3-288	K2	1-127	SW2	3-297	CH3	1-63, 1-169
AUDS2	1-44	K2-A	2-246	SY2	5-362	CLB3	1-65
AZ2R	3-289	KAB2	4-307	SZ2	1-124	CO3	2-226
B2	1-93	KA2	1-128	T2	2-271	DO3	2-233
B2M	7-377	KB2	3-294	TA2	1-192	DO3L	1-87
BAU2	2-218	KB2	2-247	TE2	3-300	DC3	1-60, 1-97, 1-115, 1-124, 1-152, 1-169
BE2	2-218	KK2	1-131	TM2	2-272		
BMW2	1-48, 1-50	KK2-P	1-131	TP2	1-191		
BMW2-P	1-48, 1-50	KL2	1-87, 1-125	VA2FB	1-183	DC3-P (-PC)	1-60, 1-97, 1-115, 1-124, 1-152, 1-161, 1-169
BO2	1-142	KM2	1-91, 1-165, 1-180, 3-298	VA2-GTS	1-183		
BT2-SI	1-200			WAR2	1-207		
BU2	1-66, 1-87, 1-161			WB2	1-52, 1-125		
BW2	2-217			WK2	2-273		
CA2	1-66, 1-200			WK2-PC	2-273		
CB2	2-225	KT2	1-134	WN2	2-220, 2-274	DK3	1-67
CE2	1-198	KYM2-SI	1-135	WO2	3-301	DM3	1-140, 1-170, 1-200
CG2	1-70, 1-128, 1-160	L2	2-248	WR2	2-273		
	1-160	LA2	1-136	WS2	1-71	DT3	1-157
CG2RP-SI	1-55	LB2	5-358	WT2	1-67	DXD3	2-233
CLB2	1-65	LD2	2-248	WTP2	2-274	EL3	2-235
CNA2	1-56	LF2	3-296	X2	1-143	EZ3	2-238
CO2	2-226	LK2	3-295	XPA2	3-298	FA3	2-237
DB2	1-197	LU2	6B-373	Y2	2-279	FIC3	2-238
DE2	2-32	LWC2	3-295	YH2	2-207	FL3	2-238
DH2	1-69	M2	2-250	YS2	1-88, 1-161	FT3	1-87, 1-200
DM2	1-170, 1-200	ME2	3-297	YU2	1-200, 1-211	GH3	1-190
DO2	2-234	MIT2	1-61, 1-152	ZKN2	3-302	GL3	3-293
DT2	1-157	MIW2	3-297	3F-1033	7-381	GT3	1-70, 1-137, 1-142
DW2	3-290	MR2	2-25	3F-1232	7-381		
EC2	3-290	MS2	1-60	3F-1630	7-381	HAW3	2-240
EL2	2-235	MTK2P	3-297	3F-1738	7-381	HD3	1-109
EZ2	2-238	MZ2	1-143	3F-2635	7-381	HF3	1-147
FA2	2-237	N2M	1-50, 1-189	3F-2830	7-381	HL3	2-241
FC2	1-53, 1-88	NE2	1-67	3F-2933	7-381	HN3	1-104
		NI02T	1-123, 1-160, 1-187	3F-4333	7-382	HO03-GTK	1-38, 1-108
		NI02FB	1-159	3F-4535	7-382	HO03-GTS	1-38, 1-109
		NI02-GTK	1-123, 1-159	3F-4735	7-382	HO03-PT	1-38, 1-108
		NI02-GTS	1-123, 1-159	3F-4935	7-382	HON-3B	1-109
		P2	2-256	3F-6932	7-382	HO03FB	1-108
		PHA2	2-256	3M-5935	7-382	HU3	3-294
		PO2	1-170	3S-1832	7-382	HY3	1-116
				3S-2332	7-382		



ILCO Number	Sec - Page(s)	ILCO Number	Sec - Page(s)	ILCO Number	Sec - Page(s)	ILCO Number	Sec - Page(s)
HYD3	1-104	Y3	2-280		1-137,	WS4	1-71
IN3	2-244	YH3	2-207		1-142,	X4	1-80, 1-143
KA3	1-128	YM3	1-67, 1-87,		1-146	YH4	2-207
KAB3	3-294		1-135,	LWC4	3-295	Z4	1-92
KB3	2-247		1-147,	LWC4R	3-295	5B	7-377
KIA3R-GTS	1-134		1-161	M4	2-250	5D1R-NS	4-307
KIA3RFB	1-134	Z3H	1-155	MIT4	1-61, 1-152	AP5	2-221
KIA3RMH	1-133	4	3-295	MIT4-P	1-61, 1-152	AS5	3-286
KK3	1-131	4R	3-295	MS4R	2-249	B5	1-42, 1-51,
KK3-P	1-131	AL4	1-40, 1-71	MZ4	1-80, 1-143		1-110,
KM3	1-91,	AB4	3-284	NE4	1-52,		1-131,
	1-165,	AM4	2-216		1-136,		2-241
	1-180	AP4	2-221		1-165	B5	1-51, 1-110,
KT3	1-134	AR4	2-215,	NI04FB	1-159		1-131,
LA3	1-136		2-217	NI04T	1-123,		2-241
LB3	5-358	B4	1-52		1-159	BR5	1-52,
LF3	3-296	BU4	3-289	PT04-PT	1-102		1-176,
LK3	3-295	CA4	1-87	PT04-PT5	1-102		1-198
LWC3	3-295	CE4	1-87	PU4	2-256	CE5	1-46, 1-198
LEC3R	3-295	CH4	1-63	PZ4	3-297	CEM5	1-26
M3	2-250	CLB4	1-65	RA4	1-42	CH5	1-63
ME3	3-297	CO4	2-226	RD4	3-298	CLB5	1-65
MIT3	1-61, 1-152	CR4R	1-147	RK4	1-175	CO5	2-228
MIT3-4B	1-155	CR4RP	1-147	RO4	2-254	DE5	2-232
MN3	5-359	DE4	2-232	RU4	2-258	DO5	2-234
MR3	2-252	DM4	1-170,	RV4	1-177	DT5	1-157
MZ3	1-143		1-200	RV4-P	1-177	DWO5AP	1-69
N3	2-255	DO4	2-233	VE4	1-199	DWO5RAP	1-69
PN3	1-92	DT4	1-157	YM4	1-147	DWO5RT5	1-69
PU3	2-256	DW04R-GTS	1-101	S4	2-267	DW05T5	1-69
PZ3	3-297	DWO4RAP	1-69	S4-AUS	3-299	DXG5	2-233
R3	2-257	DWO4RT5	1-69, 1-101	SB4	1-177	EZ5	2-238
RA3	1-42	DW04RT6	1-69, 1-101	SC4	2-215,	FB5	1-182
RO3	2-254	DXD4	2-233		2-238,	FL5	2-238
RU3	2-258	EZ4	2-238		2-269	FL5G	2-236
S3	2-267	FB4	1-182	SE4B	1-180	FT5R	1-87
S3-AUS	3-299	FL4	2-238	SE4C	1-180	FTH5	3-293
SB3	1-177	GE4	1-172	SF4-SI	1-142	GH5	2-239
SE3B	1-180	GT4	1-137	SG4	5-357,	GT5	1-137
SE3C	1-180	GU4R	3-298		5-360	H5	1-76
SF3-SI	1-142	HAW4	2-240	SJ4	1-184	HAW5	2-240
SJ3	1-184	HD4	1-109	SM4	1-165,	HD5	1-109
SP3	1-71, 1-141	HF4	1-147		1-180	HD5R	1-109
SR3	1-87	HO4	2-220	SP4	1-71, 1-141	HF5	1-147
SUB3	1-185	HON-4B	1-109	SS4	2-270	HO05-PT	1-109
SUZ3	1-187	HY4	1-116	ST4	2-271	HY5	1-116,
SY3-NS	5-362	HY4-P	1-116	SUB4-3B	1-186	HY5-P	1-152
T3	2-271	HYD4	1-104	SUB4FB	1-185		1-116,
TE3	2-240,	IN4	2-243	SUB4-GTK	1-185		1-152
	2-246,	K4	4-307	SUB4-PT	1-185	HYD5	1-104
	3-300	KA4	1-128	SUZ4	1-187	K5	4-305
TM3	2-272	KK4	1-132	SX4	3-299	KA5	1-128
TOY-3B	1-197	KK4-P	1-132	SY4	5-362	KA5-SI	3-294
TP3	1-191	KL4	1-47	SZ4AP-SI	1-55, 1-103	KK5	1-32
VS3	1-199	KM4	1-92	SZ4P	1-187	KK5-P	1-32
WA3	1-207	L4	2-248	SZ4R	1-188	KM5	1-92
WAR3	1-207	L4RM	3-295	SZ4RP	1-188	KW5	2-247
WB3	1-81	LA4	1-136	TA4	1-192	LA5	1-137
WO3	3-301	LB4	5-358	TE4	3-300	LB5	5-358
WR3	2-215,	LF4	1-46, 1-53,	TM4	2-272	LF5	1-141,
	2-237,		1-88,	TOY-4B	1-197		1-198,
	2-273		1-179,	TOY-4B2	1-197		3-296
WS3	1-71		1-198	TP4	1-191	LK5	3-295
WT3	1-47	LK4	3-295	WAR4	1-207	M5	2-250
X3	1-143	LN4	1-70,	WR4	2-237	MB5	1-51,

ILCO Number	Sec - Page(s)	ILCO Number	Sec - Page(s)	ILCO Number	Sec - Page(s)	ILCO Number	Sec - Page(s)
	1-123, 1-140, 1-200, 1-205	DE6-P	2-215, 2-232	WS6	1-72	S7JA	3-301
		DO6	2-234	X6	1-157, 1-184	SB7	1-178
MIT5	1-61, 1-152	DT6	1-157	Y6	2-275	SC7	2-269
MZ5	1-80, 1-143	FB6	1-182	YH6-SI	1-207	SF7AF	1-40
NE5	1-51, 1-105, 1-178	FL6	2-238	YM6	1-161	SM7	1-180
		FT6	1-52, 1-71, 1-87, 1-157, 1-165	7B	7-377	SP7	1-41, 1-46, 1-74, 1-143
NI05T	1-123, 1-159	FT6R	1-43, 1-52, 1-71, 1-126, 1-157	7DC	1-64, 1-164, 1-165, 1-173, 3-298	SUZ7	1-188
PA5	1-44			ALP7	3-285	SY7	5-362
PG5	1-167			AS7	3-286	T7	2-271
PO5	1-170			B7M	7-377	TA7	1-182
PO5-P	1-170	H6	1-75, 2-242	BR7	1-52, 1-176, 1-198	TM7	2-272
PU5	2-257	HD6	1-110	BUR7	3-290	TO7	3-300
RO5	2-254	HF6	1-147	CB7	2-225	X7	1-157
S5	2-267	HY6	1-116	CE7	1-87	XL7	2-274
SB5	1-177	HY6-P	1-116	CH7	1-63, 1-169	YH7	1-207
SE5F	1-180	HY6R	1-104	CLB7	1-65	YM7	1-161
SF5-SI	1-142	HYD6	1-104	CO7	2-226	ZD7	1-131, 1-156, 1-168, 1-198, 3-302
SG5	5-363	HYN6FB	1-118	CU7	1-151	8	4-308
SJ5	1-184	HYN6-GTS	1-118	DT7	1-157	8B	7-377
SP5	1-46, 1-71	HYN6MH	1-118	FB7	1-183	AS8	3-284
SS5	2-270	HYN6T14	1-118	FC7	1-43, 1-66, 1-81, 1-90, 1-126, 1-165, 1-179	BU8	3-290
SUZ5	1-188	KA6	1-128			BUR8	3-290
SY5-NS	5-362	KK6-P	1-132	FC7-P	1-43, 1-66,1-81, 1-90, 1-127, 1-165, 1-179	CE8	1-87
SZ5	1-103	KM6	1-91			CH8	1-64
SZ5P	1-188	L6FM	3-295			CLB8	1-65
TA5	1-192	L6S	3-295			CU8	1-151
TO5	3-300	LA6	1-71, 1-137			DE8	2-232
TP5	1-191	LB6	5-358			DT8	1-157
UN5	3-300	LF6	3-296			EL8	2-243
VE5	1-199	LK6	3-295			FC8	1-88
WR5	2-236, 2-273	ME6	3-297	FL7	2-238	FL8	2-238
		MIT6	1-152	GE7	1-66, 1-172	HYD8	1-104
WR5-PC	2-273	MIT6-P	1-153	GR7	3-293	IN8	2-215, 2-244, 2-257
WS5	1-71, 1-171, 1-200	MZ6	1-143	HD7	1-110	KA8	1-128, 3-294
		NA6	2-255	HF7	1-147	KK8-P	1-132
WT5	1-44, 1-201	NI06-P	1-159	HYD7	1-104	KM8	1-166, 1-181, 3-295, 3-298
X5	1-80, 1-143	PA6	1-44	HYN7RMH	1-118, 1-133	LA8	1-137
Y5	2-275	PO6	1-171			LB8	5-358
YH5	2-207	RI6	3-298	K7	4-307	LC8	3-295
YL5	1-176, 3-301	S6	2-267, 3-294	KA7	1-128	LF8	3-296
		S6BW	1-47	KK7-PT	1-132	LK8	3-295
YM5	1-147	SB6	1-178	KM7	1-92	MIT8FB	1-153
6D1R-NS	4-309	SC6	2-269	LA7	1-72, 1-137	MIT8-GTK	1-153
ALP6	3-285	SJ6	1-184	LB7	5-358	MIT8-PT	1-153
AP6	3-285	SM6	1-180	LF7	1-141, 3-296	MIT8TE-GTS	1-153
AS6	3-284	SP6	1-41, 1-46, 1-74, 1-143	LK7	3-295	MZ8	1-143
B6	7-377			MA7	2-249	NE8	1-48, 1-70
BL6	1-52, 1-126	SR6	1-184	MIT7	1-153	PA8	1-44, 1-203
BO6	1-142	SUZ6	1-188	MZ7	1-143	PA8-P	1-44, 1-204
BR6	1-52, 1-176, 1-180	SY6-NS	5-362	NE7	1-52, 1-87, 1-191	SB8	1-178
		TA6	1-192	NI07T	1-159	SC8	2-269
CE6	1-52, 1-87	TM6	2-272	PO7	1-171	SF8	1-40
CH6	1-63	TO6	3-300	R7DC	1-63, 1-165, 1-173	SMS8	1-63, 1-180,
CLB6	1-65	TP6	1-191				
DAT6BP	1-157	VA6MH	1-183	RO7	2-254		
DAT6P	1-157	VE6	1-199	S7-AUS	3-294		
DAT6RP	1-157	VL6	1-206	RU7	2-261		
DE6	2-215, 2-232	VL6-P	1-206	S7BW-P	1-47		
		VO6	1-205				
		WR6	2-273				



ILCO Number	Sec - Page(s)	ILCO Number	Sec - Page(s)	ILCO Number	Sec - Page(s)	ILCO Number	Sec - Page(s)
SP8	1-181 1-41, 1-46, 1-74	SZ9P	1-188	YH10	1-207	MIT12-PT	1-154
SUZ8	1-188	TA9	1-192	AB11	3-284	MZ12	1-143,
SY8-NS	5-362	TM9	2-272	B11	1-93		1-157,
TA8	1-192	X9	1-44,	BL11	1-141,	NA12	1-186
TL8	3-300		1-171,		1-207		1-151,
TM8	2-272	Y9	1-201	BUR11	3-290		2-254
VL8	1-206	YH9	2-280	CB11	2-225	OP12	1-161
VL8-P	1-206	YM9	1-207	CLB11	1-65	SUZ12	1-188
X8	1-201	ZD9P-SI	1-161	CS11	3-288	SY12	5-362
Y8	2-274, 3-301	AB10	1-55, 1-156	DM11	3-291	TA12	1-192
YH8	1-207	ALP10	3-284	DT11	1-157	TM12	2-272
YM8	1-161	AS10	3-284	EL11	2-235	X12	1-166,
9B	7-377	B10	1-93	HD11	1-110		1-173
9CS	3-291	CB10	2-225	HF11	1-161	Y12	1-56, 1-91,
9CX	3-288	CLB10	1-65	HYD11	1-104		1-115,
9FAC	3-292	CO10	2-223	IL11	2-271		1-168,
9MX	3-293	CS10	3-288	KA11	1-129		1-184,
ALP9	3-285	CU10	1-151	KW11	2-247		1-211,
AS9	3-284	DAV10	1-141	LA11	1-137		2-241,
BR9	1-52, 1-176, 1-198	DM10	3-291	LF11	3-294		2-242
		DT10	1-157	M11	2-250	YH12	1-207
BW9MH	1-50	EL10	2-235	MIT11RTE-GTS	1-154	00113	4-310
CB9	2-225	FL10	2-238	MZ11	1-144	13D	4-310
CLB9	1-65	FO10-GTS	1-86	NE11	1-166	AB13	3-284
CO9	2-223	FT10	1-88	NSN11T2	1-158	AS13	3-288
CO9	2-223	FT10R	1-88	OP11	1-97, 1-161	BR13	1-53
CU9	1-151	GR10	3-293	RO11	2-254	CLB13	1-65
D9	2-274	GT10BT2/5	1-72	SB11	1-178	DT13	1-157
DE9	2-232	HD10	1-110	SF11	1-88	EA13	2-234
DT9	1-157	HYD10	1-104	SUZ11	1-188	HD13	1-110
ES9	2-236	HYN10MH	1-118	SY11	5-362	HF13	1-88
FC9	1-88	KI10R	1-92	TA11	1-192	LK13	3-293
FL9	2-238	KK10-P	1-121,	TL11	3-300	YM13	1-161
GE9	1-172		1-132	TL11R	3-300	HY13	1-116
GR9	3-293	KM10	1-166	WS11	1-92	HY13-P	1-116
HD9	1-109	KW10	2-247, 2-271	X11	1-188	HYD13	1-104,
HF9	1-147		2-247, 2-271	Y11	1-56, 1-151, 1-168, 2-241, 2-280		1-135, 1-156
HY9	1-104	KW10-PC	2-247, 2-271		1-151, 1-168, 2-241, 2-280	KA13	1-129
HYD9	1-104	LA10	1-137, 1-172	YH11	1-208	L13	2-248
IL9	1-151	LF10	3-296	12B	7-377	LA13	1-137
K9	4-310	LH10	3-289	AB12	3-284	LF13	1-53
KK9-PT	1-132	LK10	3-295	AS12	3-284	LK13	3-295
KM9	1-166	M10	2-250	BH12-SI	1-51	M13	2-250
LA9	1-137	MZ10	1-80, 1-143	CLB12	1-65	MAZ13AP	1-144
LF9	3-296	MZ10-P	1-80, 1-144	CO12	2-224	MAZ13EP	1-144
LK9	3-295	NE10	1-51, 1-135, 1-141	CS12	3-288	MIT13-PT	1-154
MIT9-GTK	1-64, 1-153		1-122	CU12	1-151	MS13	1-60
MIT9-PT	1-153	NSN10	1-122	DT12	1-157	MZ13	1-81, 1-144
MZ9	1-80, 1-143	OM10	1-70, 1-127, 1-160	FT12R	1-201	MZ13-P (-PC)	1-81, 1-144
MZ9-P	1-80, 1-144		1-160	HD12	1-110	MZ13R	1-144
NE9	1-72	S10	2-267	HF12	1-88, 1-161	NE13	1-72, 1-173
NSR9CS	3-288	S10LAA-P	1-39	HY12	1-116	RO13	2-255, 2-257
R9CS	3-289	SB10	1-178	HY12-P	1-116	SY13	5-362
S9-AUS	3-299	SC10	2-269	HYD12	1-105, 1-189	TM13	2-272
SC9	2-269	SUZ10	1-188		1-128	X13	1-46, 1-53, 1-88, 1-179,
SF9	1-40	SY10	5-362	KA12	1-132		1-198
SM9C	1-181	SZ10RP	1-188	KK12-P	1-130	Y13	2-280
SP9	1-40, 1-136	TM10	2-272	KW12-SI	1-130	Y13	2-241
SUZ9	1-188	WS10	1-92	KW12BP-SI	1-130	YH13	1-208
SX9B	2-274	X10	1-157	LA12	1-137	00114	4-309
SY9	2-270			LF12-SI	3-296	14KH	3-302
SZ9	1-188			M12	2-250		

ILCO Number	Sec - Page(s)	ILCO Number	Sec - Page(s)	ILCO Number	Sec - Page(s)	ILCO Number	Sec - Page(s)
AB14	3-284	HD15	1-110		1-197	M18	2-250
AS14	3-288	HF15	1-147	YH16	1-207	MB18	1-147
DT14	1-157	HY15	1-116	ZD16RP-SI	1-43, 1-44,	MB18-P	1-147
CLB14	1-65	HY15-P	1-116		1-47, 1-55,	NE18	1-63,
GE14	1-172	HYD15	1-105		1-125,		1-166,
HD14	1-110	HYN15FB	1-120		1-142,		1-173,
HF14	1-147	HYN15-GTS	1-120		1-147,		1-181
HY14	1-116	HYN15MH	1-119,		1-168,	SUZ18	1-187,
HY14-P	1-116		1-133		1-176,		1-188,
HYN14FB	1-119	KA15	1-129		1-190,		1-189
HYN14-GTS	1-119,	KW15BP	1-128		1-210	TM18	2-272
	1-133	LF15	1-53	YM16	1-147	TR18	1-192
HYN14RFB	1-119	MB15	1-147	17B	7-378	X18	1-128,
HYN14RMH	1-119,	MB15-P	1-147	AB17	3-284		1-208
	1-133	MZ15	1-143	AS17	3-288	YH18	1-208
HYN14RT14	1-119,	NA15	2-254	B17	7-378	AB19	3-284
	1-133	NE15	1-173	CG17	2-221	AS19	3-287
HYN14T14	1-118	RO15	2-255	CO17	2-223	HD19	1-109
HYN14R-GTS	1-119	SC15	2-269	DAT17-GTS	1-185	LF19	3-296
KA14	1-129	SUZ15	1-187	DAT17T13	1-185	HYD19	1-105
KW14	1-70,	SUZ15-P	1-187	DAT17T42	1-186	M19	2-251
	1-128,	TA15	1-192	HD17	1-109	MZ19	1-144
	1-189,	TM15	2-272	HF17	1-201	MZ19-P (-PC)	1-144
	1-197,	YH15	1-207	HY17	1-117	NE19	-181
	1-200	YM15	1-88	HY17-P	1-117	RT19	1-166,
KW14AP	1-128	YM15T5-SI	1-63	HYD17	1-105		1-173
KW14P	1-70	AB16	3-2842	HYN17BTE-GTS	1-120	SC19	2-269
KW14R	1-128	B16	1-52, 1-93	HYN17RBTE-GTS	1-121	TA19	1-192
LA14	1-137	BR16	1-53	KI17	1-92	TM19	2-272
LF14	3-296	CG16	1-56, 1-91,	KW17T5-SI	1-70	WB19	2-273
M14	2-250		1-115,	LF17	1-54,	X19	1-110
MIT14-GTK	1-154		1-122,		1-125,	YH19	1-208
MIT14-PT	1-154		2-221,		1-143,	AB20	3-284
MZ14	1-144		2-241		1-179	AS20	3-287
NA14	2-254	DT16	1-157	M17	2-250	B20	7-378
NE14	1-173	GT16T2	1-40	MB17	1-147	BR20	1-53, 1-88
RO14	2-252	HD16	1-110	MD17	2-232,	DA20	1-143
SZ14RP	1-131	HF16	1-147		2-251	DM20	1-45
SZ14RAP	1-188	HY16	1-50, 1-117	MIT17A-PT	1-154	DT20	1-157
TA14	1-191	HY16-P	1-117	MZ17	1-144	EL20	2-235
TM14	2-272	HYD16	1-105	NE17	1-173	H20	4-308
Y14	1-115,	KA16	1-129	SUZ17	1-187	HD20	1-109
	1-151,	KW16C-P	1-30	SUZ17-P	1-187	HF20	1-48
	1-184,	KW16-GTS	1-130	SZ17R-GTS	1-189	HY20-PT	1-117,
	1-211	KW16MH	1-130	SZ17RMH	1-189		1-132
YH14	1-208	LF16	3-296	TM17	2-272	ILP20	3-294
ZD14RP	1-171	M16	2-250	YH17	1-208	LF20	3-297
15D	4-310	MB16	1-147	X17	1-60, 1-179	LF20S	3-297
15K	4-308	MB16R	1-147	ZD17RAP-SI	1-103,	M20	2-251
AB15	3-284	MIT16A-PT	1-154		1-168	MB20	1-148
AS15	3-287	MZ16	1-144	AB18	3-284	MZ20	1-144
AU15	1-44	MZ16-P	1-144	AS18	3-2868	NE20	1-173,
CLB15	1-65	NE16	1-173	DX18R	2-233		1-181
DT15	1-157	RU16	2-261	H18	1-76	SC20	2-269
EL15	2-235	S16	2-267	HD18	1-109	SL20	2-271
GE15	3-293	SIP16T2	1-137	HF18	1-156	SUZ20-P	1-187
GT15RAP	1-40,	SUZ16	1-189	HY18-GTS	1-117	TG20	2-273
	1-168,	TA16	1-192	HY18-P	1-117	TM20	2-272
	1-199	TM16	2-272	HY18R-GTS	1-117,	VW20	1-201
GT15RBT2/5	2-72	UN16	1-53, 1-126		1-132	X20	1-53, 1-88
GT15RDT5-SI	1-69,	X16	1-60,	HY18R-P	1-117,	YH20	1-208
	1-168,		1-179,		1-132	21B	7-379
	1-200		1-186	HYD18	1-105	AB21	3-284
GT15RP-SI	1-168	Y16	1-50, 1-115,	IN18	2-244	CC21	2-222
GT15RT2	1-40		1-189,	LF18	3-296	DM21	3-291

INDEX

ILCO Number	Sec - Page(s)	ILCO Number	Sec - Page(s)	ILCO Number	Sec - Page(s)	ILCO Number	Sec - Page(s)
EL21	2-235	TA23	1-192	LF25	2-220,	CS29	3-288
FO21-GTS	1-86	X23	1-128		3-297	F29	1-39
FO21FB	1-86	YH23	1-208	M25	2-251	HD29	1-105,
FO21MH	1-86, 1-127	YM23	1-161	MZ25	1-144		1-110
FO21T7	1-127	ZD23RCP-SI	1-47, 1-50,	MZ25-P	1-145	HF29	1-156
FO21T7-SI	1-86		1-125,	NA25	2-216,	IN29	2-243
H21	4-306		1-142		2-255	M29	2-250
HD21	1-109	ZD23RT5-SI	1-43,	RN25	1-42, 1-175	MZ29	1-145
HF21	1-161		1-142,	SP25A	1-38	NE29	1-173
HY21	1-117		1-147	SP25A-P	1-40	RN29	1-42, 1-60,
HY021-PT	1-121	24	3-296	TA25	1-192		1-175
LF21	3-296	24A	3-296	TR25	1-192	VC29	1-174
LK21	3-295	24B	7-380	VC25	1-65	X29	1-46, 1-53,
M21	2-251	24CL	3-296	YM25	1-161		1-179,
TA21	1-193	B24	1-93	X25	1-188		1-205
X21	1-88, 1-161	DA24	1-58	YH25	1-209	YH29	1-208
YH21	1-128,	DM24	3-292	CO26	2-241	YH29BP	1-209
	1-208	HD24	1-110	CS26	3-288	YH29P	1-189,
YM21	1-161	HON24	1-110	H26	1-76		1-209
ZD21P-SI	1-55, 1-138	HON24RP	1-110	HD26	1-109	YH29RBP	1-209
22BB	7-380	IN24	2-218,	HF26	1-48, 1-156	YH29RP	1-189,
22M	7-380		2-244	M26	2-251		1-209
AB22	3-284	LF24	1-141,	NE26	1-181	YM29	1-88,
AK22W	2-216		3-297	TA26	1-192		1-162,
CG22	2-221	MAZ24FB	1-146	TR26	1-192		1-198
DM22-SI	3-292	MAZ24-GTK	1-146	VC26	1-65, 1-174	C30M	7-380
DM22TVP	3-292	MAZ24-GTS	1-146	X26	1-80, 1-143	CC30	2-222
F22	1-72	MAZ24RT5	1-145	YH26	1-169,	DA30	1-158
HD22	1-109	MAZ24R-PT	1-146		1-209	DA30-P	1-158
HF22	1-88	NA24	2-219,	27B	7-380	DXD30	2-233
HY22	1-118		2-254	AS27	3-288	HD30	1-105,
HY022-PT	1-121	RN24	1-42,	EA27	2-235,		1-110
MZ22	1-144		1-167,		2-240	ILP30	3-294
NE22	1-173,		1-175	H27	1-76	MZ30	1-145
	1-174	RN24-P	1-42,	M27	2-250	MZ30-P	1-145
S22	2-263		1-167,	MZ27	1-145	NE30	1-46
S22 1/2	2-263		1-175	MZ27-P (-PC)	1-145	RN30	1-42, 1-61,
SC22	2-269	TA24	1-192	NE27	1-166		1-167,
SIP22FB	1-75, 1-143	VC24	1-63, 1-174	RN27	1-42, 1-175		1-175
SIP22-GTS	1-61, 1-72,	X24	1-128	TA27	1-193	VC30	1-65, 1-174
	1-75	YH24	1-208	V27	2-203	S30FD-P	1-88
SIP22MH	1-60, 1-71,	YM24	1-161	X27	1-81, 1-143	X30	1-205
	1-75	ZD24RAT22-SI	1-210	YH27	1-209	YH30	1-209
SIP22T5-SI	1-103,	ZD24RDP-SI	1-47, 1-69,	YM27	1-161	YH30BP	1-209
	1-168		1-103,	YM27T2	1-161	YH30P	1-209
SK22RT1	1-183		1-115,	AS28	3-288	YH30RBP	1-209
X22	1-88, 1-161		1-135,	DA28	1-123,	YH30RP	1-209
YH22	1-208		1-147,		1-158	YM30	1-88,
YM22	1-161		1-156,	HD28	1-109		1-162,
ZD22RBP-SI	1-43, 1-47		1-190,	IN28	2-243		1-198
23B	7-380		1-198,	M28	2-250	YM30T5	1-178
23M	7-380		1-210	TA28	1-192	ZD30T5-SI	1-43, 1-156
AB23	3-284	ZD24RMH	1-115	TR28	1-192	DA31	1-122,
AS23	3-286	ZD24RT5-SI	1-210	TR28-P	1-192		1-158,
DA23	1-158,	ZD24RT14-SI	1-115	VC28	1-65		1-184
	1-184	25	2-220	X28	1-176	DA31-P (-PC)	1-123,
DA23-P	1-158,	25B	7-378	YH28	1-209		1-158,
	1-184	25B-AUS	3-296	YH28BP	1-209		1-185
DM23	3-292	AS25	3-286	YH28P	1-209	HD31	1-105,
HD23	1-105,	DA25	1-158,	YH28RBP	1-209		1-110
	1-110		1-184	YH28RP	1-209	HON31AP	1-113
HF23	1-88	DA25-P (-PC)	1-158,	YM28	1-162	HON31BP	1-113
HY23	1-118		1-184	YM28T2	1-161	HON31CP-SI	1-114,
LF23	3-296	HD25	1-110	ZD28RFP-SI	1-49		1-135
NE23	1-40, 1-72	ILP25	3-294	CC29	2-222	HON31AP	1-113

ILCO Number	Sec - Page(s)	ILCO Number	Sec - Page(s)	ILCO Number	Sec - Page(s)	ILCO Number	Sec - Page(s)
HON31BP	1-113		1-190	F39	1-40, 1-71	TOY43RT45	1-186
HON31P	1-113	X34	1-128	HD39	1-110	YH43	1-208
HON31RAP	1-113	Y34	2-275	HON39P	1-110	B44	1-94
HON31RBP	1-113	YH34	1-190	MB39	1-150	B44G	4-305
HON31RCP-SI	1-114	CO35	2-226	MB39-P	1-150	B44GP	4-305
HON31RP	1-112	DA35	1-159	NE39	1-166,	B44-P (-PC)	1-94
MZ31	1-145	HD35	1-105,		1-174	F44	1-45, 1-72
NE31	1-166		1-110	TR39	1-193	FT44	1-39
RN31	1-42, 1-61,	HF35	1-201	X39	1-208	HO44	1-105,
	1-175	IN35	2-243	YH39	1-208		1-111
S31	2-268	IN35-PC	2-243	AS41	1-178	NE44	1-166
VC31	1-65	V35	1-45	F40	1-40, 1-71	OP44	1-162
YH31	1-208	V35-P	1-45	HD40	1-109,	RU44	2-258
YH31R	1-208	X35	1-129		1-110	T44	6B-372
YH31RAP	1-208	YH35	1-190,	HF40	1-48	TOY44D-PT	1-103,
YH31RBP	1-208		1-210	ILP40	3-294		1-195
AS32	3-284	YH35RBP	1-208,	LX40	1-140	TOY44G-PT	1-195
DA32	1-158		1-210	MB40	1-150	TOY44H-PT	1-195
DA32-P	1-158	YH35RMH	1-209	NE40	1-174	TR44	1-194
EA32	2-234	CO36	2-226	T40	6B-372	TR44-P	1-194
HD32	1-105,	HD36	1-110	TG40	2-273	X44	1-105
	1-110	IN36	2-244	TOY40BT4	1-138	YH44	1-209
HON32P	1-105	NE36	1-42, 1-175	TOY40FB	1-139	45B	7-378
OP32	1-162	OP36	1-162	TOY40-GTK	1-134,	B45	1-95
PH32	2-256	X36	1-144		1-138,	B45G	4-305
RN32	1-42, 1-61	YH36	1-43, 1-209		1-196	B45GP	4-305
RN32-P	1-42, 1-61	37 MASTER	7-378	TOY40B-GTS	1-139,	B45-P (-PC)	1-95
S32	2-268	CO37	2-226		1-196	FCT45	3-293
S32FJ-P	1-88, 1-126	DA37	1-159	TR40	1-69, 1-194	GM45FB	1-102
S32YS-P	1-178	DA37-P	1-160	TR40-P (-PC)	1-69, 1-194	GM45-GTK	1-101
V32	1-131,	FT37	1-39, 1-45,	YH40	1-208	GM45-GTS	1-102
	1-165,		1-70, 1-72,	41FD	2-222	HD45	1-111
	1-201		1-125,	B41A	7-378	INF45-PT	1-123
X32	1-171		1-136,	F41	1-40, 1-71	NE45	1-166,
YH32	1-209		1-165,	HF41	1-66		1-174
33NO	3-300		1-211	HO41	1-105,	RU45	2-259
DA33	1-158	HD37	1-110		1-110	T45	6A-368
F33	1-39, 1-72	HF37	1-156	HON41	1-114	X45	1-193
HD33	1-105,	OP37	1-161	HON41P-SI	1-114	YH45	1-209
	1-110	T37L	6A-371	MB41	1-150	AS46	3-287
IN33	2-243	TR37	1-193	MB41-P	1-150	B46	1-42, 1-94
KA33	1-130	V37	1-204	NE41	1-166	B46G	4-305
S33FD-P	1-88	V37-P (-PC)	1-204	X41	1-128	B46GP	4-305
S33FJ-P	1-89, 1-126	X37	1-192	YH41	1-208	FT46	1-37, 1-41,
TR33	1-105,	YH37	1-209	HD42	1-110		1-71,
	1-193	AS38	3-287	HON42	1-110		1-136,
TR33-P (-PC)	1-105,	DA38	1-160	HON42AP	1-110		1-211
	1-193	DA38-P	1-160	NE42	1-166	HD46	1-110
V33	1-204	F38	1-39, 1-71	YH42	1-208	HF46	1-66
X33	1-208	FT38	1-39, 1-45,	B43	1-93	HU46T2	1-98
YH33	1-169,		1-70, 1-72,	FT43	1-41, 1-75,	NE46	1-166
	1-209		1-125,		1-136	RU46	2-259
34B	7-380		1-136,	HD43	1-110	T46	6B-373
DA34	1-158		1-165,	HF43	1-41, 1-162	TR46	1-194
DA34-P	1-159		1-211	HU43P	1-162	TR46-P (-PC)	1-194
HD34	1-110	HD38	1-110	HU43T2	1-162	X46	1-193
IN34	2-243	HF38	1-162	NE43	1-166	YH46	1-50, 1-56,
KA34	1-130	HON38RP	1-106	OP43	1-162		1-130,
NE34	1-181	MB38	1-150	TOY43AT4	1-195		1-169,
S34YS-P	1-148	X38	1-105,	TOY43FB	1-195		1-210
YH34	1-170,		1-110	TOY43-GTK	1-102,	AS47	3-288
	1-209	YH38	1-170,		1-195	B47	1-95
YH34P-SI	1-125,		1-210	TOY43-GTS	1-102,	B47G	4-305
	1-210	DA39	1-160		1-195	HD47	1-111
YH34RP-SI	1-125,	DA39-P	1-160	TOY43RH-PT	1-186	HF47	1-162



ILCO Number	Sec - Page(s)	ILCO Number	Sec - Page(s)	ILCO Number	Sec - Page(s)	ILCO Number	Sec - Page(s)
NE47	1-166	B50G	4-305	M54G	2-238	H60	1-79
OP47	1-162	B50-P (-PC)	1-94	ML54G	2-238	HD60	1-111
TR47	1-194	H50	1-78, 1-145	N54B	2-234	OP60C	1-162,
TR47-P	1-194	H50-PC	1-78, 1-145	N54G	2-223,		1-201
TR47-PC	1-194	HF50	1-162		2-234	S60	3-302
WT47T	1-180	ILP50	3-294	NE54	1-72	S60HF-P	1-205
YH47	1-50, 1-55,	S50HF-P	1-148	P54F	2-220,	S60R	3-302
	1-130,	TOY50-PT	1-140		2-235	X60	1-144
	1-169,	TR50	1-194	S54F	2-233,	Z1-60-5	4-307
	1-189,	X50	1-53, 1-125		4-307	Z1-60-6	4-307
	1-210	YH50	1-50, 1-56,	S54F-PC	2-235	61D	1-39, 1-73,
AS48	3-288		1-170,	S54G	2-236		1-141,
B48	1-93		1-190,	UN54	3-300		1-155
B48G	4-305		1-209	X54	1-60, 1-97,	61E	1-39, 1-73
B48GP	4-305	51	6B-373		1-124,	61F	1-39,
B48-P (-PC)	1-93	AS51	3-287		1-151,		1-731-141
HD48	1-111	B51	1-95		1-187	61G	1-39, 1-73
FT48	1-40	B51G	4-305	Y54	2-277	61GA	1-39, 1-73
NE48	1-81,	B51GP	4-305	B55	1-97	61H	1-39, 1-73,
	1-131,	B51-P (-PC)	1-95	H55	1-79		1-137
	1-165,	H51	1-78	HF55-P	1-171	61J	1-73
	1-179,	H51-PC	1-78	NE55	1-72	61JD	3-290,
	1-183	HD51	1-111,	X55	1-53		3-294,
S48HF-P	1-148		1-168	YM55	1-50, 1-56,		3-298,
TOY48BT4	1-139	TOY51-P	1-197		1-170,		3-299
TOY48 EMER THIN	1-196	UN51	3-300		1-210	61N	1-48, 1-51,
TOY48-FB	1-139	X51	1-44, 1-46,	B56	1-97, 1-193		1-67,
TOY48-GTS	1-139,		1-53,	H56	1-79		1-138,
	1-196		1-105,	HD56	1-111		1-148,
TOY48-GTK	1-122,		1-126	HF56	1-199		1-201
	1-134,	YH51	1-50, 1-56,	NE56	1-55	61NA	1-67, 1-89,
	1-139,		1-170,	X56	1-46		1-138,
	1-196		1-190,	YM56	1-50, 1-56,		1-148
TOY48H-PT	1-196		1-209		1-170,	61NC	1-148,
TR48	1-194	AS52	3-287		1-210		1-171,
X48	1-208	B52	1-92, 1-93	B57	1-124		1-201
YH48	1-43, 1-50,	H52	1-78	DM57	3-292	61P	1-89, 1-181
	1-55,	HF52-P	1-171	HD57	1-55, 1-111	61PC	1-89, 1-181
	1-130,	RU52	2-261	HF57	1-148	61PE	1-166,
	1-169,	X52	1-178	NE57	1-73		1-181
	1-189,	Y52	2-275	TOY57-PT	1-195	61PS	1-166,
	1-209	YH52	1-210	X57	1-111		1-181
49B	7-378	YH52R	1-210	HD58	1-111	61Q	3-286
B49	1-94	53 MASTER	7-378	HON58RMH	1-114	61TS	1-39, 1-73
B49G	4-305	AS53	3-286	HON58RTE-GTS	1-114	61T	3-286
B49GP	4-305	B53	1-97, 1-124	NE58	1-73	61VW	1-193,
B49-P (-PC)	1-95	C53	7-378	S58HF-P	1-148		1-171,
GTHT49C	1-109	H53	1-78	X58	1-111		1-201
HD49	1-111	HD53	1-111	AS59	3-288	61W	3-286
HF49	1-162	RU53	2-259	B59	1-97	A61Q	3-286
HU49AT2/5	1-45	S53HF-P	1-48	H59	1-81	A61W	3-284
HU49T1	1-204	TR53	1-194	H59-P (-PC)	1-81	AR61Q	3-284
NE49	1-53	TR53-P	1-194	HD59	1-111	AR61W	3-284
S49HF-P	1-148	X53	1-131,	HF59	1-162	AS61	3-288
TR49	1-193		1-165,	HF59R	1-162	B61	1-97, 1-164
TOY49-GTS	1-134		1-201	MB59	1-148	DR61F	1-73
TOY49TE-GTS	1-22	54KP	2-234	NE59	1-73	H61G	1-39, 1-46,
X49	1-208	A54B	2-215	X59	1-48, 1-50		1-73, 1-142
YH49	1-43, 1-50,	AS54	3-288	Z1-59A1-6	4-307	H61N	1-65, 1-67,
	1-55,	B54	1-97, 1-115	Z1-59A2-6	4-307		1-137
	1-130,	F54	1-45, 1-72,	Z1-59B1-6	4-307	H61NA	1-67, 1-148
	1-169,		1-180	Z1-59C1-6	4-307	H61P	1-181
	1-189,	H54	1-72, 1-145	Z1-59C2-6	4-307	H61SA	1-89
	1-209	H54-PC	1-72, 1-145	Z1-59D2-6	4-307	H61SB	1-89
B50	1-94	L54K	2-235	AS60	3-286	H61VM	1-48, 1-51,

ILCO Number	Sec - Page(s)	ILCO Number	Sec - Page(s)	ILCO Number	Sec - Page(s)	ILCO Number	Sec - Page(s)
H61VO	1-67, 1-148, 1-201	T61C	1-193	62DX	1-54, 1-126	62VW	1-202
H61VR	1-67 1-53, 1-67, 1-71, 1-89, 1-148, 1-178, 1-201	T61C-P	1-193	62DW	1-201	62WA	1-68
HD61	1-111	T61D	1-193	62FE	1-54	62WVB	1-44, 1-68
HO61C	1-111	T61E	1-193	62FG	1-54, 1-126	62Z	1-65, 1-167, 1-174, 1-181
HO61D	1-111	T61F	1-193	62FS	1-43, 1-54, 1-126, 1-160, 1-198, 1-206	A62VC	1-89, 1-202
HO61E	1-111	T61G	1-193	62FT	1-43, 1-47, 1-54, 1-80, 1-89, 1-126	A62VN	1-68, 1-149, 1-163, 1-202
HO61H	1-111	T61VR	1-67, 1-89, 1-201	62HA	1-176	AB62C	3-284
HO61Q	1-110	U61VW	1-171, 1-201	62HB	1-176	AB62CR	3-284
HO61R	1-111	V61A	1-206	62HC	1-176	AB62E	3-284, 3-291
HR61N	1-65	V61S	1-65, 1-92, 1-167, 1-174, 1-199, 3-299	62HD	1-176	AB62ER	3-284, 3-291
HR61P	1-181	V61VW	1-171, 1-201	62HE	1-176	AB62G	3-285
HR61NA	1-67, 1-89, 1-148	VR61S	1-167, 1-174, 1-199, 3-299	62HF	1-176	AB62GR	3-285, 3-291
HV61	1-174, 1-181, 3-299	X61	1-174	62HG	1-176	B62	1-93
HVR61	1-174, 1-181, 3-299	Y61	1-155	62JB	1-176	B62DP	1-47, 1-54, 1-126
L61D	1-39, 1-46, 1-73, 1-142	62BZ	1-164	62KT	1-89	B62DR	1-47, 1-54, 1-126, 1-199
L61G	1-39, 1-73Z	62DB	1-176, 1-207	62LG	1-191	B62G	1-68, 1-136, 1-149
LR61D	1-39, 1-46, 1-73, 1-142	62DC	1-53, 1-126, 1-179, 1-180	62PD	1-161	B62-P-1	1-95
LR61G	1-39, 1-73	62DE	1-53	62PE	1-163	B62-P-2	1-95
R61D	1-39, 1-73, 1-141	62DF	1-53, 1-89, 1-180	62PF	1-163	B62-P-3	1-95
R61E	1-73	62DG	1-39, 1-53, 1-89, 1-126, 1-179, 1-180, 1-199, 1-206	62PG	1-163	B62-P-4	1-95
R61F	1-173	62DH	1-53, 1-126, 1-179	62PH	1-163	B62-P-5	1-95
R61JD	3-298	62DJ	1-54	62PI	1-163	B62-P-6	1-95
R61G	1-39, 1-73, 1-155	62DK	1-53, 1-126	62PJ	1-163	B62-P-7	1-95
R61GA	1-39, 1-73	62DM	1-53, 1-126	62PK	1-163	B62-P-8	1-95
R61H	1-39, 1-73, 1-137	62DN	1-173, 1-199, 1-206	62PL	1-163	B62-P-9	1-95
R61NA	1-67, 1-89, 1-138, 1-148	62DO	1-173	62PM	1-163	B62-P-10	1-95
R61P	1-181	62DP	1-43, 1-53, 1-126, 1-155, 1-176, 1-179, 1-198, 1-199, 1-206, 1-207	62PN	1-163	B62-P-11	1-95
R61Q	3-284	62DJ	1-54	62PO	1-163	B62-P-12	1-95
R61ST	1-39, 1-73	62DK	1-53, 1-126	62PP	1-163	B62-P-13	1-95
R61TS	1-39, 1-73, 1-141	62DM	1-53, 1-126	62PQ	1-163	B62-P-14	1-95
R61W	3-286	62DN	1-173, 1-199, 1-206	62PR	1-163	B62-P-15	1-95
RE61F	1-166	62DO	1-173	62PS	1-163	CO62	2-226
RE61N	1-40, 1-51, 1-174	62DP	1-43, 1-53, 1-126, 1-155, 1-176, 1-179, 1-198, 1-199, 1-206, 1-207	62PT	1-163	DM62	3-292
RE61XR	1-39, 1-166, 1-174, 1-181	62DV	1-157, 1-184	62PU	1-163	H62	1-79
SR61N	1-131, 1-155, 1-189	62DU	1-157	62PV	1-163	H62BZ	1-164
SR61W	1-178, 1-205	62DT	1-157, 1-184	62VH	1-51, 1-67, 1-73, 1-89, 1-135, 1-202	H62DP	1-43, 1-54, 1-176, 1-179, 1-199, 1-207
T61A	1-193	62DU	1-157	62VJ	1-51, 1-67, 1-73, 1-89, 1-135, 1-140, 1-163, 1-191	H62DR	1-54, 1-199
T61B	1-193	62DV	1-157	62VK	1-148, 1-163	H62FD	1-202
				62VL	1-148, 1-163	H62P	1-79
				62VM	1-67, 1-163	H62PD	1-163
				62VN	1-48, 1-68, 1-163, 1-202, 1-206	HD62	1-111
				62VP	1-163	H62DG	1-179
						H62DP	1-54, 1-198
						H62DR	1-54, 1-198
						H62VG	1-51, 1-149
						H62VK	1-48, 1-68
						H62VP	1-163



ILCO Number	Sec - Page(s)	ILCO Number	Sec - Page(s)	ILCO Number	Sec - Page(s)	ILCO Number	Sec - Page(s)
HR62BZ	1-164	VO62	1-44, 1-206	H63	1-81	64G	2-242
HR62DG	1-41, 1-54, 1-179, 1-186	W62VB	2-202	H63FD	1-89	64K	1-172, 1-199, 1-203
HR62FD	1-202	W62VE	2-202	H63G	1-65, 1-92, 1-167, 1-182	64KK	1-172
HR62PD	1-163	X62VK	1-209			64P	1-173
HR62VG	1-51, 1-149	X62VK	1-48	H63M	1-149	64R	1-175
HR62VK	1-68, 1-202	Y62	1-73	H63VO	2-203	64RD	2-242
L62DM	3-300	YR62	1-73, 1-137	HD63	1-112	64S	1-74
L62FD	1-47, 1-54, 1-90	63	1-68, 1-140, 1-143, 1-200	HR63FD	1-89	64SS	1-184
L62VA	1-66, 1-68, 1-103	63A	1-68, 1-149, 1-151	L63G	1-167, 1-182	64X	1-175
L62VB	1-68, 1-171, 1-202		1-149, 1-149	LR63G	1-65, 1-167, 1-182	64Y	1-138
L62VJ	1-163	63C	1-149			AS64	3-287
L62VN	1-68, 1-163	63E	1-90, 1-124, 1-149	M63B	1-140, 1-149, 1-171, 1-206	B64	1-94
LR62DG	1-54		1-124, 1-149			B64GP	4-305
LR62US	3-288	63F	1-51, 1-136	M63BG	1-140, 1-149, 1-171, 1-202, 1-206	B64-P (-PC)	1-94
LR62VA	1-66, 1-211	63G	1-167, 1-182			H64	2-252
LR62VB	1-68, 1-90		1-167, 1-182			H64E	1-90, 3-295
R62DG	1-39	63H	1-92, 1-149, 1-167, 1-182			H64K	1-164
R62DH	1-43, 1-54		1-149, 1-167, 1-182	M63E	1-149	H64S	2-252
R62DM	1-53, 1-126, 1-160, 1-180, 1-198	63J	1-149, 1-211	MR63E	1-149	HD64	1-112
R62PD	1-161		1-138, 1-149	N63G	1-167, 1-182	HON64BP-SI	1-114
R62PE	1-68	63K	1-138, 1-149			HON64RBP-SI	1-114
R62PF	1-163		1-149, 1-68,			HR64K	1-164
R62PG	1-163	63L	1-124, 1-136, 1-140, 1-202, 1-211			HU64-GTK	1-60, 1-91, 1-150
R62PZ	1-164, 1-173		1-124, 1-136, 1-140, 1-202, 1-211				
R62TS	1-40, 1-73	63LL	1-164			HU64P-SI	1-150
R62UC	1-65, 1-141, 1-181	63M	1-41, 1-167, 1-175			M64	2-252
R62US	1-174, 3-288		1-167, 1-167	NR63G	1-167	P64H	1-164
R62VA	1-149, 1-211	63P	1-167	R63E	1-68, 1-90	P64K	1-164, 1-175
R62VB	1-51, 1-90, 1-124	63PX	1-167	R63G	1-167, 1-182		
R62VN	1-149, 1-171	63Q	1-51, 1-167, 1-175	R63H	1-74, 1-92, 1-167, 1-182	T64	6A-368
R62WA	1-44, 1-68		1-167, 1-175			VW64T	1-66, 1-203
R62Z	1-167, 1-174, 1-181	63SP	1-41, 1-73			X64	1-41, 1-46, 1-74, 1-143
S62DP	1-54, 1-90, 1-207, 1-211	63ST	1-41, 1-74, 1-142				
S62DR	1-54		1-41, 1-74	R63K	1-138, 1-149	YM64	1-210
S62DW	1-202	63TS	1-41, 1-74			65CA	1-182
S62FD	1-149	63TW	1-41, 1-74	R63KE	1-90, 1-149	65CB	1-182
S62VP	1-140, 1-163	63TVK	1-41, 1-74	R63Y	1-48, 1-90	65CD	1-182
S62VT	1-163	63V	1-41, 1-74	R63PX	1-167	65CE	1-182
U62VA	1-180	63VP	1-41, 1-74	R63SP	1-41, 1-73, 1-142	65CF	1-182
U62VB	2-202	63VO	1-41, 1-74	R63ST	1-41, 1-74, 1-142	65FA	1-74, 1-155
U62VN	2-202	63VR	1-41, 1-74			65G	1-74, 1-155
U62VP	1-97, 1-161	63VS	1-41, 1-74	R63TK	1-90	65J	1-90, 1-211
UR62VP	1-161	63W	1-41, 1-74	R63TS	1-41, 1-74	65K	1-150
		63WG	1-41, 1-74	R63TY	1-90	65M	1-51, 1-68, 1-74
		63Y	1-41, 1-74	R63V	1-199	65T	1-90
		A63L	1-41, 1-74	R63VS	2-203	65TA	1-158
		AS63	1-41, 1-74	R63W	1-136, 1-149	B65	1-97, 1-107, 1-124
		B63	1-41, 1-74				
		B63-P (-PC)	1-41, 1-74	R63WG	2-203	B65-P	1-98, 1-107, 1-124
		B63GP	1-41, 1-74	R63Y	1-51		
		CO63	1-41, 1-74	S63B	2-203	F65	1-68, 1-136, 1-150, 1-182
		G63Y	1-41, 1-74	U63H	1-149, 1-164, 1-203		
				VW63	1-203		
				VW63A	1-203		
				X63	1-209		
				XD63	1-68, 1-140	F65A	1-182
				U63H	1-172	F65L	1-182
				YM63	1-210	FR65	1-182
				64AL	1-138, 1-172	FR65A	1-182
						FR65S	1-182
						H65	1-81
				64D	2-242		

ILCO Number	Sec - Page(s)	ILCO Number	Sec - Page(s)	ILCO Number	Sec - Page(s)	ILCO Number	Sec - Page(s)
H65-P	1-81	VW67	1-203	H73FB	1-82	B80-P	1-98
HD65	1-113	VW67S	1-203	H73-GTK	1-82	R80B	1-175
P65A	1-164	X67	1-209	H73-PT	1-82	X80	1-206
P65C	1-164	B68	1-95	H73Z	1-113	LX80	1-140
R65FA	1-74, 1-155	B68GP	4-305	HD73	1-111	T80J	1-193
R65G	1-74, 1-155	B68-P (-PC)	1-95	S73	2-268	V80P	1-180,
S65CA	1-182	CO68	2-241	VO73	1-46, 1-53,		1-206
UF65A	1-182	F68C	1-138		1-179,	A81N	1-41, 1-44,
X65	1-209	F68YT	1-43, 1-47,		1-205		1-172
66A	1-74,		1-54, 1-80,	VO73S	1-205	BR81R	1-54
	1-137,		1-89	B74	1-106,	F81E	1-43, 1-52,
	1-155	HD68	1-112		1-124		1-71
66B	7-379	M68	1-148	B74-P	1-106,	X81	1-66
66BB	1-74,	S68	2-267		1-124	B82-P-2	1-95
	1-137,	UN68	3-300	H74-PT	1-82	B82-P-3	1-95
	1-155	X68	1-209	HD74	1-113,	B82-P-4	1-95
F66C	1-74	B69	1-97		1-135	B82-P-5	1-95
H66	1-80	HD69	1-113	NE74P-SI	1-168	B82-P-6	1-95
H66-P	1-80	X69	1-209	NE74T5-SI	1-167	B82-P-7	1-95
HD66	1-112	70S	6B-373	X74	1-209	B82-P-8	1-95
HU66-P	1-204	F70S	1-53, 1-179	H75	1-82	B82-P-9	1-95
HU66T1	1-204	H70	1-81	H75 EMER	1-86	B82-P-10	1-95
HU66T5	1-172,	H70-P	1-81	H75-PC (-PC)	1-83	B82-P-11	1-95
	1-204	H70X	1-113	HD75	1-113,	B82-P-12	1-95
HU66T6	1-204	H70XR	1-112		1-135	B82-P-13	1-95
HU66T24	1-204	H70Z	1-112	NE75EHP	1-179	B82-P-14	1-95
HU66T28	1-204	HD70	1-105	X75	1-209	B82-P-15	1-95
HU66T88	1-204	HD70U	1-106	F76M	1-90	H82-PT	1-83
HU66A-P	1-45	HON70MH	1-114	H76	1-83	HD82	1-106
HU66AT2	1-45	HON70T14-SI	1-114	H76-P	1-83	HD82-P	1-106,
HU66AT5	1-45	S70	2-268	H76G	1-110		1-110
HU66AT6	1-45	T70	6A-368	H76X	1-110	X82	1-150
HU66FB	1-205	X70	1-104	X76	1-209	X83	1-150
HU66-GTS	1-204	H71	1-81	B77	1-94	84B	7-380
HU66MH	1-172,	H71-P	1-81	B77GP	4-305	AS84	3-288
	1-204	HD71	1-105	B77-P (-PC)	1-94	B84	1-95
J66M	1-127	NE71R	1-179	H77P	1-113	H84FB	1-86
P66E	1-173	NE71RDP	1-168,	H77PR	1-113	B84GP	4-305
S66NN-P	1-206		1-179	HON77TE-GTS	1-115	B84-P	1-95
X66	1-209	VW71	1-203	V77	1-205	H84-GTK	1-83, 1-146
67	4-30767H	VW71A	1-203	VW77	1-90,	H84-GTS	1-83
		X71	1-106		1-126,	X84	1-113,
67J	1-110	Y71H	1-207		1-203		1-135
67LB	1-112	AS72	3-288	X77	1-210	B85	1-95
L67LC	1-112	B72	1-98	B78	1-94	B85G	4-305
67LD	1-112	B72-P	1-98	B78GP	4-305	X85	1-42, 1-175
B67	1-95	D72D	1-157	B78-P (-PC)	1-94	AS86	3-288
B67G	4-305	H72FB	1-86	H78	1-83	B86	1-95
B67K	1-112	H72G	1-104	H78-P	1-83	B86GP	4-306
C67K	1-112	H72-GTK	1-82, 1-146	V78JK	1-203	B86-P	1-96
D67K	1-112	H72-GTS	1-82	X78	1-41, 1-46,	B86-PC	1-96
E67K	1-110	H72H	1-104		1-74	H86-PT	1-83
H67	1-79	H72KR	1-104	79B	7-379	H86 SERVICE KEY	1-84
H67K	1-110	H72-PT-CLEAR	1-82	B79	1-95	T86	6B-373
H67-P (-PC)	1-79	HD72	1-111	B79G	4-305	X86	1-43, 1-66,
L67A	2-222,	M72F	1-53, 1-179	H79M	1-113		1-81, 1-90,
	3-301	V72E	1-203	H79MR	1-113		1-126,
R67K	1-110	V72N	1-203	O79JC	1-164		1-165,
S67K	1-110	X72	1-43, 1-209	O79JD	1-164		1-179
S67NN-P	1-206	73VB	1-44,	O79JE	1-164	B87	1-131
SR67K	1-110		1-171,	P79B	1-172	CO87	2-228
T67C	2-223		1-201	X79	1-41, 1-46,	CR87	2-232
T67D	2-223	73VB-P	1-44,		1-74, 1-143	H87-P	1-84
U67K	1-112		1-171,	AS80	3-288	X87	1-188
U67KR	1-113		1-201	B80	1-98	CO88	2-228



ILCO Number	Sec - Page(s)	ILCO Number	Sec - Page(s)	ILCO Number	Sec - Page(s)	ILCO Number	Sec - Page(s)
CR88	2-232	F91GH	1-41, 1-46	X97	1-104	B103-PT	1-98
X88	1-44, 1-203	F91GS	1-41, 1-46,	B98-PT	1-96	B103-PT5	1-98
B89	1-96		1-74, 1-142	B98-PT5	1-96	HD103	1-107
B89GP	4-306	F91H	1-41, 1-46	HD98	1-106	HD103-P (-PC)	1-107
B89-P	1-96	F91HH	1-41, 1-46	HD98-P (-PC)	1-106	X103	1-129
CO89	2-227	F91HS	1-41, 1-46,	HY98	1-103	Y103	2-241,
CR89	2-232		1-74	X98	1-104		2-242,
X89	1-166	GU91F	3-293	B99-PT	1-96		2-270
90B	7-379	GU91G	3-293	B99-PT5	1-96	104AM	2-221
HD90	1-106	HD91	1-106	HD99	1-37	B104-P-2-ILCO	1-98
HD90-P (-PC)	1-106	HD91-P	1-106	HD99-P	1-37	B104-P-3-ILCO	1-98
INF90	1-122	OP91S	1-164	100AM	2-221	B104-P-4-ILCO	1-98
LXP90-P	1-138,	OP91SV	1-164	100-C#	4-307	B104-P-5-ILCO	1-98
	1-145,	PA91	1-165	100-C-NS#	4-307	B104-P-6-ILCO	1-98
	1-194	PR91C	3-298	100-E	4-307	B104-P-7-ILCO	1-98
LXV90-P	1-138,	PR91CS	3-298	100-E-NS	4-307	B104-P-8-ILCO	1-98
	1-145,	S91W	1-181	B100-PT	1-96	B104-P-9-ILCO	1-98
	1-194	SK91E	1-183	B100-PT5	1-96	B104-P-10-ILCO	1-98
X90	1-129	SK91H	1-183	HD100	1-37	B104-P-11-ILCO	1-98
91B	7-379	TT91	1-191	HD100-P	1-37	B104-P-12-ILCO	1-98
B91	1-96	VR91	3-301	HU100BMW	1-49	B104-P-13-ILCO	1-98
B91GCP	4-306	VR91A	3-301	HU100FB	1-100	B104-P-14-ILCO	1-98
B91GOP	4-306	VR91AR	3-293,	HU100-GTK	1-100	B104-P-15-ILCO	1-98
B91-GP	4-306		3-301	HU100-GTS	1-100	B104-PT	1-98
B91-P	1-96	VR91B	3-301	X100	1-104	B104-PT5	1-98
CO91	2-227	VR91BR	3-301	101-C	4-309	HD104	1-107
CR91	2-232	VR91C	3-301	101-C LFIC	2-270	X104	1-129
CS91C	3-291	VR91CR	3-301	101C-NS-DND	2-268	HD105	1-113
CS91CR	3-291	VR91R	3-301	101-CE-NS	4-309	X105	1-129
CS91E	3-291	VR91S	3-301	101-E	4-309	B106	1-98
CS91ER	3-291	W91C	3-301	101-E LFIC	2-270	B106-P	1-98
CS91F	3-291	X91	1-129	101-E-NS	4-309	CO106	2-219,
CS91FR	3-291	Y91C	1-164	101E-NS-DND	2-268		2-225,
DK91D	1-68	Z91	1-155	101-EF-NS	4-309		2-241
DK91G	1-68	B92	1-96	101-F	4-309	HD106FB	1-107
DK91H	1-68	B92GP	4-306	101-F-NS	4-309	HD106-GTS	1-107
DK91K	1-68	B92GV	4-306	B101	1-107,	HD106-PT	1-107
DK91L	1-68	B92-P	1-96		1-125	HD106-PT5	1-107
DK91U	1-68	H92-PT	1-84	B101-P	1-107,	X106	1-129
F91C	1-41, 1-46,	HD92	1-37		1-125	HD107-PT5	1-108
	1-71, 1-74,	H92FB	1-85	HD101	1-37, 1-47	HD107-PT5	1-108
	1-136,	HD92-P	1-37	HD101-P	1-37	X107	1-209
	1-143	HU92R-GTS	1-49	HU101 EMER	1-85	HD108	1-113
F91C2	1-41, 1-46,	HU92RBMW	1-49	HU101FB	1-85	X108	1-184
	1-71, 1-74,	HU92RMH	1-49	HU101-GTS	1-85, 1-177	HD109	1-113
	1-136,	HU92RMHK	1-49	HU101MH	1-85, 1-177	HU109FP-SI	1-177
	1-143	X92	1-42, 1-175	HU101T-SI	1-85	X109	1-41, 1-75,
F91C8	1-41, 1-46,	B93	1-96	RU101	2-229,		1-136
	1-71, 1-74,	B93GOP	4-306		2-260	B110	1-98
	1-136,	B93GP	4-306	X101	1-104	B110-P	1-98
	1-143	B93-P	1-96	Y101	1-184,	DM110	3-292
F91CR	1-41, 1-46,	HD93	1-37		2-280	HD110-P	1-113
	1-71, 1-74,	X93	1-104	102AM	2-221	X110	1-204
	1-136,	B94	1-131	B102	1-97	B111FB	1-99
	1-143	H94-PT	1-84	B102GCP	4-306	B111-GTK	1-99, 1-187
F91E	1-41, 1-46	HD94	1-106	B102-GMP	4-306	B111-GTS	1-99
F91EH	1-41, 1-46	X94	1-104	B102GOP	4-306	B111-PT	1-98
F91ES	1-41, 1-46,	HD95	1-106	B102GP	4-306	HD111-GTK	1-38
	1-74	X95	1-104	B102-P	1-97	HD111-PT	1-38
F91F	1-41, 1-46	HD96	1-37	HD102	1-37	X111	1-50, 1-56,
F91FH	1-41, 1-46	HD96-P	1-37	HD102-P	1-37		1-210
F91FS	1-41, 1-46,	X96	1-104	VAC102-GTS	1-175	B112-PT	1-99
	1-74	B97-PT	1-96	VAC102T1	1-175	C112	7-379
F91G	1-41, 1-46,	B97-PT5	1-96	X102	1-104	X112	1-50, 1-56,
	1-103	HD97	1-37, 1-75	103AM	2-221		1-210

ILCO Number	Sec - Page(s)	ILCO Number	Sec - Page(s)	ILCO Number	Sec - Page(s)	ILCO Number	Sec - Page(s)
B113	1-125	X130	1-106	X158	1-124	G190	2-239,
HD113-PT	1-109	T131	6A-368	X159	1-193		2-240
X113	1-75	X131	1-81,	Y159	1-59	G190B	2-239
B114-PT	1-99		1-144,	Y159-P	1-60	G190C	2-239
B114R-GTK	1-98		1-178	X160	1-115,	G190M	2-240
X114	1-158	X132	1-204		1-152	G190MA	2-240
B114R-PT	1-99	HU133-GTS	1-190	Y160-GTK	1-62,	X190	1-106
X115	1-158,	HU133RMH	1-190		1-154,	191A	3-301
	1-184	X133	1-104		1-183	G191	2-239
00116	4-309	Y133	1-57, 1-184	Y160-GTS	1-62	X191	1-106
B116	1-99	X134	1-104	Y160FB	1-62	192	3-299
X116	1-42,	X135	1-104	Y160-PT	1-61	192B	3-299
	1-167,	X136	1-104	X161	1-116	A192	3-285
	1-175	X137	1-105,	X162	1-97	G192	2-239
B117	1-100		1-193	Y162-PT	1-62	X192	1-98
X117	1-43, 1-50,	138	1-141,	X163	1-141,	G193	2-239
	1-55,		1-183,		1-207	X193	1-37
	1-130,		1-200	Y164-GTS	1-62, 1-155	G194	2-239,
	1-169,	X138	1-113,	Y164-PT	1-62, 1-154		2-240
	1-189,		1-135	Y165-PT	1-62	L194	1-141
	1-209	Y138	1-58	X167	1-200,	X194	1-37, 1-75
X118	1-43, 1-50,	139	1-183		1-211	X195	1-106
	1-55,	X139	1-45	X166	1-40	X196	1-116,
	1-130,	X140	1-206	X168	1-97, 1-164		1-152
	1-169,	X141	1-104	X169	1-81	G197	2-239,
	1-189,	X142	1-104	170S	6B-373		2-240
	1-209	X143	1-97, 1-124	170S6	6B-373	X197	1-158
B119	1-100	143D	5-359	X170	1-81,	G198	2-239
B119-PT	1-100	X144	1-48		1-131,	HU198T	1-85
X119	1-50, 1-55,	C145	2-270		1-165,	X198	1-106,
	1-130,	X145	1-97		1-179,		1-124
	1-169,	X146	1-97, 1-193		1-183	G199	2-239,
	1-189,	Y146	1-58	Y170-GTK	1-64		2-240
	1-210	X147	1-42, 1-61,	Y170MHK	1-63	H199A	1-56
B120-PT	1-100		1-167,	Y170-PT	1-64, 1-205	H199N	1-175
X120	1-50, 1-56,		1-175	Y171-P	1-63	X199	1-144
	1-130,	X148	1-167	X171	1-42, 1-61,	200W	4-310
	1-169,	TS149	6B-374		1-175	X200	1-144
	1-210	Y149	1-59	C172F	3-293	Y200	3-302
X121	1-37, 1-60,	TS150	6B-374	Y172	1-63	201	6A-366
	1-97, 1-115,	X150	1-42, 1-175	Y173-PT	1-63	201-AUS	3-296
	1-124,	X151	1-193	X174	1-69, 1-194	X201	1-144
	1-152,	X152	1-41, 1-71,	X175	1-42, 1-61	202	3-294
	1-169		1-136,	X176	1-61, 1-152	X202	1-81
B121	1-100		1-211	178SB	1-127,	Y202	2-279
B122	1-100	Y152	1-59		7-379	X203	1-204
H122AL	1-128	Y152-PC	1-59	X178	1-144	X204	1-37
H122ALR	1-128	T153	6A-366	X179	1-188	Y204	2-274,
K122AR	1-128	X153	1-211	180A	4-310		3-302
X122	1-42, 1-60,	Y153	1-59	X180	1-97, 1-112	X205	1-37
	1-175	Y153-P	1-59	X181	1-106	X206	1-144
C123	2-270	X154	1-97, 1-124	X182	1-106	X207	1-81
C123 CONTROL	2-270	Y154	1-59	X183	1-37	X208	1-37
X123	1-158,	Y154-P	1-59	184K	3-294	C209	3-297
	1-184	Y154-PC	1-59	X184	1-97,	X209	1-37
T124	6B-374	155	5-359		1-107,	X210	1-122,
X124	1-123,	X155	1-125		1-124		1-158,
	1-158	Y155	1-59	185V	3-301		1-184
125C	1-137	Y155-P (-PC)	1-59	R185V	3-301	X211	1-194
125CR	1-137	X157	1-54,	X185	1-187	X212	1-194
X125	1-104		1-125,	X186	1-187	X213	1-61, 1-152
X126	1-104		1-143,	X187	1-116	X214	1-107
X127	1-104		1-179	X188	1-144	X215	1-107
H128-PT	1-84	Y157	1-59	X189	1-37	X216	1-116
X129	1-106	Y157-P (-PC)	1-59	A190	3-285	X217	1-194

ILCO Number	Sec - Page(s)	ILCO Number	Sec - Page(s)	ILCO Number	Sec - Page(s)	ILCO Number	Sec - Page(s)
X218	1-193	X264	1-153	884R	5-362	998SE	2-278
C219	3-298	X265	1-113	885	5-363	998SF	2-278
X219	1-194	X266	1-129	885BL	5-363	998SG	2-278
X220	1-194	X267	1-132	885R	5-363	998SH	2-278
Y220	2-279	X268	1-160	887	5-357,	998SMK	2-278
X221	1-81	X269	1-132		5-363	998SV	2-279
Y221	2-279	X270	1-43, 1-49,	889A	2-274	998TA	2-278
X222	1-145		1-54, 1-50,	S900	2-247	998TB	2-278
Y222	2-279		1-70,	994ARM	2-274	998TD	2-278
X223	1-194		1-125,	994M	2-275	998TE	2-278
Y223	2-280		1-135,	997A	2-275	998TF	2-278
X224	1-61, 1-152		1-142,	997B	2-275	998TG	2-278
X225	1-98		1-156,	997D	2-275	998TH	2-278
X226	1-105,		1-168,	997DA	2-275	998TMK	2-278
	1-189		1-197	997DB	2-275	998VA	2-276
X227	1-158	X271	1-185	997E	2-275	998VB	2-276
X228	1-158	X272	1-185	997EB	2-275,	998VC	2-276
X229	1-61, 1-152	X274	1-105		3-289	998VD	2-276
X231	1-81	X275	1-125	997ER	2-277,	998VE	2-276
X230	1-145	275LA-NS	4-309		3-289	998VF	2-276
X232	1-116	275S-NS	4-309	997G	2-275	998VG	2-276
X233	1-131	X276	1-189	997GR	2-275	998YA	2-276
X234	1-104,	X277	1-210	997GX	2-275	998YB	2-276
	1-135,	X278	1-130	997JA	2-275	998YC	2-276
	1-156	X279	1-130	997JB	2-275	998YD	2-276
X235	1-116	X280	1-116	997JC	2-275	998YE	2-276
X236	1-116	X281	1-117	997JD	2-275	998YG	2-276
X237	1-158	X282	1-117	997JE	2-275	998YH	2-276
X238	1-159	X283	1-105	997JF	2-275	998ZA	2-279
X239	1-177	X284	1-105	997L	2-275	998ZB	2-279
X240	1-131	X285	1-105	997LA	2-275	998ZC	2-279
X241	1-187,	X286	1-105	997PA	2-275	998ZD	2-279
	1-188,	X287	1-105	997X	2-275	A998GST	2-277
	1-189	X290	1-208	B997EH	2-277	H998R	2-276
X242	1-159	B308	4-308	H997E	2-275	H998SA	2-278
X243	1-160	B310	4-308	H997EB	2-275	H998SB	2-278
X244	1-83	E375	6A-368	H997ER	2-275	H998SD	2-278
X245	1-61, 1-152	610B	6A-368	J997M	2-275	H998SE	2-278
X246	1-113	615	6A-368	J997MR	2-275	H998SG	2-278
X247	1-145	621A	6A-367	O997E	2-277	H998SMK	2-278
X248	1-210	U621A	6A-367	O997ER	2-277	H998TA	2-278
X249	1-145	666	6B-372	O997G	2-277	H998TB	2-278
X250	1-107,	669	6B-372,	R997DA	2-275	H998TE	2-278
	1-125		7-381	R997EB	2-277	H998TMK	2-278
X251	1-185	672	6A-366	998GL	2-277	H998YMK	2-276
X252	1-113	704K	1-57	998GST	2-277	H998ZA	2-279
X253	1-131	706	5-359	998LA	2-277	H998ZB	2-279
X254	1-129	719S	6B-373	998LB	2-277	999	2-215,
X255	1-129	723	5-359	998LC	2-277		2-279,
X256	1-129	725	6A-366	998LD	2-277		3-289,
X257	1-129	750	2-235,	998LE	2-277		3-271,
X258	1-129		2-238	998LF	2-277		3-298
X259	1-55, 1-70,	752	1-168,	998LG	2-277	999A	2-279,
	1-129,		2-220,	998PA	2-279		3-289,
	1-156,		2-233,	998PB	2-279		3-290
	1-169,		2-238	998PC	2-279	999B	2-279,
	1-189,	755	2-235	998PD	2-279		3-285
	1-197,	757	2-235,	998PE	2-279	999CA	2-279
	1-200		2-238	998PF	2-279	999GA	3-289,
X260	1-129,	759ST	2-270	998PH	2-279		3-302
	1-169	760	2-235	998R	2-276	999GB	3-289,
X261	1-129,	765	2-235	998SA	2-278		3-302
	1-169	775	2-238	998SB	2-278	999GC	3-289,
X262	1-129	884	5-362	998SC	2-278		3-302
X263	1-152	884BR	5-362	998SD	2-278	999GD	3-289,

ILCO Number	Sec - Page(s)	ILCO Number	Sec - Page(s)	ILCO Number	Sec - Page(s)	ILCO Number	Sec - Page(s)
999GR	3-302	1001C	2-228	R1001EK	2-226	1007LE	2-265
999K1	3-289	1001C1	2-227	R1001EL	2-226	1007LF	2-265
999K2	2-279	1001C2	2-227	R1001EM	2-226	1007LG	2-265
999K3	2-279	1001CDM	2-227	R1001EN	2-226,	1007LH	2-265
999N	2-280	1001CM	2-227		2-270	1007LHM	2-265
999R	2-279	1001CR	2-224	R1001EP	2-226	1007LJ	2-265
	2-279,	1001D	2-224	R1001ES	2-226	1007LK	2-265
	3-289,3-	1001D1	2-227	R1001ET	2-226	1007LL	2-265
	291, 3-298,	1001D2	2-227	R1001MJ	2-226	1007LM	2-265
	3-302	1001DM	2-227	X1001KC	2-224,	1007RA	2-266
999U	2-279	1001DA	2-224		2-258	1007RB	2-266
C999	2-280	1001E	2-226	1003A	2-225	1007RC	2-266
H999	2-280	1001EA	2-226	1003AB	2-225	1007RD	2-266
H999R	2-280	1001EB	2-226	1003CD	2-225	1007RDH	2-266
X999	2-280,	1001EG	2-226	1003M	2-219,	1007RDM	2-266
	3-289,	1001EH	2-228		2-225,	1007RE	2-266
	3-292	1001EJ	2-226		2-241	1007RF	2-266
1000	2-226	1001EL	2-226	L1003A	2-225	1007RG	2-266
1000A	2-226	1001EN	2-226	L1003AB	2-225	1007RH	2-266
1000AB	2-226	1001ES	2-226	L1003M	1-151,	1007RHM	2-266
1000DA	2-223	1001FH	2-227		2-225	1007RJ	2-266
1000F	2-223	1001GH	2-228	R1003M	2-219,	1007RK	2-266
1000FR	2-223	1001GH	2-228		2-241	1007RL	2-266
1000G	2-223	1001GA	2-228	S1003A	2-225	1007RM	2-266
1000H	2-223	1001GRM	2-227	S1003AB	2-225	01007CA	2-263
1000K	2-223	1001K	2-224	S1003M	2-225	01007CB	2-263
1000KC	2-223	1001MA	2-226	1004	2-248	01007CD	2-263
1000P	2-224	1001MB	2-226	1004A	2-248	01007CDH	2-263
1000T	2-224	1001MD	2-226	1004AL	2-248	01007CDM	2-263
1000V	2-241	1001MJ	2-226	1004AR	2-248	01007CE	2-263
1000W	2-224	A1001AH	2-227	1004AXM	2-248	01007CF	2-263
1000V	2-224	A1001AM	2-227	1004KL	2-248	01007CG	2-263
1000X	2-224,	A1001ABM	2-227	1004M	2-248	01007CH	2-263
	2-241	A1001BH	2-227	1004N	2-248	01007CN	2-263
1000XK	2-224,	A1001BM	2-227	1004R	2-248	01007CR	2-262
	2-241	A1001C1	2-227	1004SN	2-248	01007HA	2-264
01000GR	2-223	A1001C2	2-227	1005	2-248	01007HB	2-264
01000GX	2-223	A1001CM	2-227	1007	2-262	01007HC	2-264
01000H	2-223	A1001CDM	2-227	1007CA	2-263	01007HD	2-264
R1000T	2-224	A1001D1	2-227	1007CB	2-263	01007HDH	2-264
R1000V	2-224	A1001D2	2-227	1007CD	2-263	01007HE	2-264
S1000T	2-224	A1001DH	2-227	1007CE	2-263	01007HF	2-264
S1000V	2-224,	A1001DM	2-227	1007CF	2-263	01007HG	2-264
	2-241	A1001EH	2-228	1007CG	2-263	01007HJ	2-264
SR1000T	2-224	A1001EHR	2-228	1007CN	2-263	01007HK	2-264
SR1000V	2-224	A1001FH	2-227	1007HA	2-264	01007HL	2-264
SX1000F	2-223	A1001GRM	2-227	1007HB	2-264	01007HM	2-264
SX1000FR	2-223	A1001HP	2-226	1007HC	2-264	01007HN	2-264
X1000F	2-223	A1001MA	2-226	1007HD	2-264	01007LA	2-265
X1000FR	2-223,	A1001MB	2-226	1007HDH	2-264	01007LB	2-265
	2-252	A1001MF	2-226	1007HE	2-264	01007LC	2-265
X1000G	2-223	A1001MJ	2-226	1007HF	2-264	01007LD	2-265
X1000GR	2-223	A1001MJR	2-226	1007HG	2-264	01007LDH	2-265
X1000KC	2-223	B1001EJ	2-226	1007HH	2-264	01007LDM	2-265
XO1000F	2-223	L1001ABM	2-227	1007HJ	2-264	01007LE	2-265
XO1000GR	2-223	L1001AH	2-227	1007HK	2-264	01007LF	2-265
1001	2-228	L1001BH	2-227	1007HL	2-264	01007LG	2-265
1001A	2-228	L1001D2	2-227	1007HM	2-264	01007LH	2-265
1001A1	2-228	L1001EH	2-228	1007HN	2-264	01007LHM	2-265
1001A2	2-228	L1001GRM	2-227	1007LA	2-265	01007LJ	2-265
1001AB	2-228	R1001CEM	2-226	1007LB	2-265	01007LK	2-265
1001ABM	2-227	R1001D	2-224	1007LC	2-265	01007LL	2-265
1001AH	2-227	R1001ED	2-226	1007LD	2-265	01007LM	2-265
1001AM	2-227	R1001EE	2-226	1007LDH	2-265	01007NB	2-262
1001BM	2-227	R1001EF	2-226	1007LDM	2-265	01007RA	2-266
		R1001EG	2-226				

INDEX

ILCO Number	Sec - Page(s)	ILCO Number	Sec - Page(s)	ILCO Number	Sec - Page(s)	ILCO Number	Sec - Page(s)
01007RB	2-266		2-260	A1011S	2-261	01014SM	2-234
01007RC	2-266	1011M	2-258	A1011T	2-261	X1014F	2-235,
01007RD	2-266	1011P	2-258	B1011D41	2-259		2-240
01007RDH	2-266	1011PAA	2-258	L1011-L4	2-229,	X1014L	2-246,
01007RDM	2-266	1011PZ	2-261		2-260		2-249
01007RE	2-266	1011S	2-258	L1011-L41	2-229,	1015	2-248
01007RF	2-266	1011T	2-258		2-260	1015C	2-248
01007RG	2-266	A1011-1N	2-261	N1011M	2-261	A1015L	2-249
01007RH	2-266	A1011-2N	2-261	N1011P	2-261	A1015LR	2-249
01007RHM	2-266	A1011-3N	2-261	N1011S	2-261	A1015M	2-249
01007RJ	2-266	A1011-4N	2-261	1012	2-262	A1015MR	2-249
01007RK	2-266	A1011-5N	2-261	1012-60	2-230	A1015N	2-249
01007RL	2-266	A1011-6N	2-261	1012A	2-262	A1015NR	2-249
01007RM	2-266	A1011-7N	2-261	1012-D1	2-230	A1015P	2-249
L1007CE	2-263	A1011-8N	2-261	A1012-59A	2-231	A1015PR	2-249
L1007CF	2-263	A1011-9N	2-261	A1012-59A1	2-231	A1015Q	2-249
L1007CG	2-263	A1011-10N	2-261	A1012-59A2	2-231	A1015QR	2-249
L1007CN	2-263	A1011-11N	2-261	A1012-59AB	2-231	A1015R	2-249
L1007LA	2-265	A1011-12N	2-261	A1012-59AD	2-231	A1015RRL	2-249
L1007LH	2-265	A1011-13N	2-261	A1012-59B1	2-231	A1015S	2-249
L1007LL	2-265	A1011-14N	2-261	A1012-59B2	2-231	A1015SR	2-249
L1007LM	2-265	A1011-15N	2-262	A1012-59C1	2-231	A1015T	2-249
N1007KMA	2-265	A1011-16N	2-262	A1012-59C2	2-231	A1015TR	2-249
N1007KMB	2-265	A1011-17N	2-262	A1012-59CD	2-231	A1015U	2-249
N1007KMC	2-265	A1011-18N	2-262	A1012-59D	2-231	A1015UR	2-249
N1007RMA	2-266	A1011-19N	2-262	A1012-59D1	2-231	A1015V	2-249
N1007RMB	2-266	A1011-20N	2-262	A1012-59D2	2-231	A1015VR	2-249
1008	2-267	A1011-21N	2-262	A1012-60	2-230	A1015W	2-249
1009	2-267	A1011-22N	2-262	A1012-D1	2-230	A1015WR	2-249
1009A	2-267	A1011-23N	2-262	A1012-D2	2-230	A1015X	2-249
1009M	2-267	A1011-24N	2-262	A1012-D3	2-230	A1015XR	2-249
01009	2-267	A1011-25N	2-262	A1012-D4	2-230	A1015Y	2-249
1010	2-267	A1011-26N	2-262	A1012-D12	2-230	A1015YR	2-249
1010A	2-267	A1011D1	2-259	A1012-D41	2-230	L1015M	2-249
1010B	2-267	A1011D2	2-259	A1012-H1	2-230	L1015MR	2-249
1010M	2-267	A1011D3	2-259	A1012-H2	2-230	1016	2-256
1010N	2-267	A1011D4	2-259	A1012-H3	2-230	1016N	2-256
1010S	2-267	A1011D12	2-259	A1012-H5	2-230	1016NB	2-256
1010U	2-267	A1011D34	2-259	A1012-H6	2-230	1017	2-255
01010	2-267	A1011D41	2-259	A1012-H7	2-230	1017A	2-255
01010A	2-267	A1011H1	2-261	A1012-H8	2-230	1017B	2-255
A1010U	2-267	A1011H2	2-261	L1012-D41	2-230	1017BA	2-255
L1010N	2-267	A1011H3	2-261	1013DL	2-234	O1017ML	2-256
1011	2-257	A1011H5	2-261	1013F	2-234	1019	2-257
1011A	2-258	A1011H6	2-261	1013G	6B-372	1019A	2-257
1011B	2-258	A1011H7	2-261	1013GR	6B-373	1019C	2-257
1011D1	2-259	A1011H8	2-261	1014	2-234	1019D	2-257
1011D2	2-259	A1011-L1	2-229,	1014A	2-234	1019DA	2-257
1011D3	2-259		2-260	1014B	2-240	1019XL	2-257
1011D4	2-259	A1011-L2	2-229,	1014C	2-240	A1019M	2-257
1011D41	2-259		2-260	1014D	2-234	1020	2-240
1011GH	2-258	A1011-L3	2-229,	1014DA	2-234	1021B	2-218
1011-L1	2-229,		2-260	1014DS	2-234	1021BA	2-218
	2-260	A1011-L4	2-229,	1014DX	2-234	1021N	2-218
1011-L2	2-229,		2-260	1014F	2-234	1022	2-270
	2-260	A1011-L12	2-229,	1014J	2-234	1022AB	2-270
1011-L3	2-229,		2-260	1014JM	2-234	1022H	2-270
	2-260	A1011-L34	2-229,	1014JSX	2-234	1022L	2-270
1011-L4	2-229,		2-260	1014K	2-234	O1022AB	2-270
	2-260	A1011-L41	2-229,	01014J	2-234	1023	2-223
1011-L12	2-229,		2-260	01014JM	2-234	1023A	2-223
	2-260	A1011M	2-261	01014JS	2-234	1028	5-356
1011-L34	2-229,	A1011P	2-261	O1014K	2-234	1028A	5-356
	2-260	A1011PZ	2-261	01014P	2-234	1028AY	5-356
1011-L41	2-229,	A1011PZR	2-262	01014S	2-234	1028C	5-363

ILCO Number	Sec - Page(s)	ILCO Number	Sec - Page(s)	ILCO Number	Sec - Page(s)	ILCO Number	Sec - Page(s)
1028D	5-360	1041T	1-56, 1-91,	1049D	2-262	L1054WC	2-237
1028DC	5-363		1-115,	1049E	2-262	L1054WD	2-237
1028DD	5-356		1-122,	1052A	5-356	MD1054K	2-232,
1028E	5-356		2-221,	1052B	5-356		2-251
1028F	5-356		2-241	1052C	5-356	N1054K	2-244
1028G	5-356	1041TR	2-221	1054	2-242	N1054WB	2-273
1028L	5-356	1041W	2-245	1054DL	2-243	O1054KR	2-251
1028N	5-356	1041X	2-221	1054F	2-243	X1054C	2-244
1028NN	5-357	1041Y	2-221	1054FN	2-243	X1054F	2-244
1028NR	2-252	C1041A	2-221	1054G	2-238	X1054GC	2-244
1028P	5-356	C1041B	2-221	1054K	2-243	X1054GD	2-244
01028AH	5-357	C1041C	2-221	1054KD	2-232	X1054GF	2-244
1031	6B-372, 6B-373	C1041DN	2-222	1054LB	2-242	X1054JA	2-244
		C1041J	2-221	1054MT	2-242	X1054JK	2-244
1033	3-300, 6B-373	C1041JB	2-221	1054N	2-243	X1054K	2-244
		C1041L	2-221	1054P	2-243	X1054SC	2-244
1033A	6B-372	C1041N	2-221	1054R	2-243	X1054WA	2-273
1033F	6B-372	C1041P	2-221	1054T	2-243	1060C	5-363
1033N	3-300	C1041R	2-221	1054TW	2-215,	1063	5-360
1034	2-256	C1041SR	2-221		2-237,	1063B	5-360
1034H	2-256	C1041T	2-221		2-273	1063D	5-360
1036	2-218	C1041TR	2-221	1054WC	2-237	1063E	5-360
1036A	2-218	C1041YR	2-221	1054WD	2-237	1063KW	4-308
1036G	2-218	H1041T	2-221	1054WF	2-237	1063KW-BR	4-308
1036S	2-218	R1041DC	2-222	1054WH	2-237	N1063KW	4-308
1036U	2-218	S1041H	2-245	1054WJ	2-237	1064	2-253
1040	1-65, 1-150	S1041JA	2-221	1054WK	2-237	1064A	2-253
1040A	1-66, 1-150	S1041T	2-221	1054WL	2-237	1064D	2-255
1040B	1-66, 1-150	SC1041R	2-221	1054WN	2-237	1064L	2-253
1040C	1-66, 1-151	SC1041S	2-221	1054WP	2-237	1064M	2-253
1040E	1-66	SC1041SR	2-221	1054WR	2-237	R1064D	2-255
1040U	1-151	SC1041T	2-221	1054UN	2-243,	R1064E	2-216,
R1040C	1-66, 1-151	SC1041TR	2-221		5-358		2-255
R1040E	1-66, 1-151	SC1041YR	2-221	1054X	2-243	S1064A	2-252
1041B	2-216	1042A	2-245	01054A	2-268	1065	2-252
1041C	2-216	1042B	2-245	A1054KD	2-232	1065C	2-252
1041CE	2-216	1042WC	2-245	A1054WB	2-237	1065D	2-252
1041D	2-222,	1042Z	2-245	A1054WC	2-237	1065E	2-252
	2-240	L1042A	2-245	A1054WD	2-237	1065F	2-252
1041DC	2-222	L1042B	2-245	A1054WF	2-237	1066	5-356
1041DE	2-222	S1042Z	2-245	A1054WH	2-237	1067B	2-222
1041DH	2-222	S1042ZM	2-245	A1054WJ	2-237	1068	5-361
1041E	2-221	S1042ZP	2-245	A1054WK	2-237	1068B	5-361
1041FE	2-222	S1042ZS	2-245	A1054WL	2-237	1068E	5-361
1041FG	2-222	1043B	1-151,	A1054WN	2-237	1069	2-241,
1041G	1-70,		2-246	A1054WP	2-237		2-252
	1-128,	1043C	2-246	A1054WR	2-237	1069-5X	2-255
	1-160,	1043D	2-246	B1054B	2-243	1069-5Y	2-255
	2-222	1043E	2-246	C1054B	1-56	1069-5Z	2-255
1041GA	1-70,	1043ED	2-246	D1054K	2-215,	1069B	1-103,
	1-128,	1043F	2-246		2-232		2-241,
	1-160,	1043G	2-246	D1054KA	2-232		2-252
	2-222	1043J	2-246,	H1054B	2-243	1069C	2-252
1041GB	1-168,		2-271	H1054L	2-244	1069D	2-252
	2-222	1045	2-216	H1054S	2-243	1069E	2-252
1041GR	1-169,	1045L	2-216	K1054B	2-218,	1069F	2-252
	2-222	A1045	2-216		2-244	1069FL	2-254
1041H	2-245	A1045L	2-216	L1054AR	2-244	1069G	2-254
1041HM	2-245	1046	2-216	L1054B	2-215,	1069H	2-254
1041K	1-169,	1046A	2-216		2-238,	1069FNA	2-252
	2-222	1047	2-262		2-244,	1069L	2-254
1041M	2-222	1047A	2-262		2-257	1069LA	2-254
1041N	2-222	1047CL	2-262	L1054G	2-238	1069LB	1-151,
1041P	2-245	1047CR	2-262	L1054JA	2-244		2-254
1041S	2-245	1047M	2-262	L1054M	2-218	1069LC	2-219,

ILCO Number	Sec - Page(s)	ILCO Number	Sec - Page(s)	ILCO Number	Sec - Page(s)	ILCO Number	Sec - Page(s)
	2-254	1092DS	2-250	D1098JD	1-127	A1114R	2-219
1069M	2-254	1092E	2-250	D1098X	2-232	A1114TB	2-219
1069N	2-254	1092F	2-250	E1098JD	1-127	1115	5-359
1069P	2-254	1092H	2-250	F1098JD	1-127	1115A	5-359
1069S	2-254	1092J	2-250	H1098A	1-93	1115AL	5-359
1069SM	2-254	1092K	2-250	H1098C	1-93	1115B	5-359
1069T	2-254	1092M	2-250	H1098DB	1-52, 1-93	1115BL	5-360
1069W	2-254	1092N	2-250	H1098L	1-93	P1115	1-98
1069YM	2-254	1092NTG	2-246	H1098LA	1-93	P1116	1-100
GF1069	2-240, 2-255	1092NR	2-250	H1098M	1-93	1119	2-235, 2-257
LC1069	2-248	1092R	2-249	H1098NR	1-42		2-271
M1069C	2-255	1092TG-ILCO	2-245, 2-246	H1098X	1-93	1120D	2-271
M1069L	1-209, 2-255	1092V	2-250	L1098C	1-93	1120F	2-271
N1069B	2-255	1092VA	2-250	L1098LA	1-93	1120H	2-271
N1069C	2-255	1092VB	2-250	L1098M	2-218	1120J	2-271
N1069E	2-255	1092VM	2-250	O1098B	1-93	1120K	2-271
N1069G	2-255	1092VM	2-250	O1098D	1-93	1120S	2-271
N1069J	2-255	1092VR	2-250	O1098-GM	306	1122D	2-280
N1069N	2-255	1093	5-363	O1098LA	1-93	H1122M	2-271
R1069L	2-255	1093H	5-363	P1098AV	1-93	01122	1-56, 1-151, 1-168, 2-241, 2-280
S1069G	2-254	1095	5-359	P1098A	1-93		
S1069H	2-254	1095A	5-359	P1098C	1-94		
S1069M	2-254	1095H	5-359	P1098CV	1-94		
S1069T	2-254	1095HL	5-359	P1098E	1-94		
1071	2-274	1096	2-235	P1098EV	1-94	01122A	1-56, 1-91, 1-115, 1-184, 2-241, 2-280
1071A	2-274	1096C	2-235	P1098J	1-42, 1-94		
1071AB	2-274	1096EN	2-222, 2-235	P1098V	1-94, 1-103		
1071B	2-274			P1098WC	1-94		
1071BD	2-274	1096FL	2-235	P1098WE	1-94		
1071BE	2-274	1096L	2-235	S1098B	1-94		
1071BM	2-274	1096NL	2-235	S1098D	1-95		
1071D	2-274	C1096C	2-235	S1098H	1-95	01122AR	1-115, 1-151, 1-168, 1-184, 2-241, 2-280
1071E	2-274	C1096CN	2-235	S1098K	1-95		
1071M	2-274	C1096LN	2-235	S1098WD	1-95		
1073	2-238	L1096CN	2-235	S1098WH	1-95		
1073K	2-238	R1096EN	2-235	P1099	1-95		
1079	2-246	S1096B	2-235	P1101	1-95		
1079AB	2-246	S1096G	2-235, 3-295	S1105	1-95		
1079B	2-246			P1106	1-95	01122B	2-241, 2-242, 2-270, 2-280
1180S	2-274	S1096JN	2-235	P1107	1-96		
1182	2-274	1098DB	1-42, 1-51, 1-115, 1-131, 2-241	1109V	1-96		
1083	2-252			P1109	1-96		
1083H	2-252	1098GM	1-52	1110A	5-363	01122BE	2-241, 2-280
1083J	2-252	1098JD	1-122, 1-127, 1-211	1110B	5-363		
1084	5-361			P1111	1-96	01122BER	2-280
1089C	5-357, 5-361			P1112	1-96	01122BR	2-241, 2-280
1091	5-359	1098L	1-51, 1-93, 1-103	P1113	1-97		
1092	2-249			P1114	1-98	01122C	2-241, 2-242, 2-280
1092-40	2-250	1098M	1-52, 1-70, 1-91, 1-141, 1-151	1114	2-218		
1092-52	2-251			A1114A	2-218	01122R	2-241, 2-280
1092-600A	2-251			A1114B	2-219		
1092-900	2-251	1098NR	1-42	A1114C	2-219	F1122A	2-280
1092-6000	2-251	1098PB	1-165	A1114D	2-219	F1122AR	2-280
1092-6000B	2-251	1098X	1-51, 1-92, 1-93, 2-241	A1114E	2-219	H1122F	2-280
1092-7000	2-251			A1114F	2-219	H1122FR	2-280
1092-7000B	2-251	1098XL	1-52	A1114FM	2-219, 2-238	H1122W	2-280
1092-8105	2-251	C1098A	1-93			K1122B	2-218
1092B	2-250	C1098JD	1-122, 1-127, 1-211	A1114G	2-219	K1122C	2-218
1092C	2-250			A1114H	2-219	K1122D	2-218
1092CNTLBI	2-250			A1114J	2-219	K1122N	2-218
1092D	2-250	D1098B	2-232	A1114K	2-219	L1122A	1-184, 2-280
1092DD	2-250	D1098BM	2-232	A1114L	2-219		
				A1114M	2-219	L1122AR	1-184, 2-280
				A1114Q	2-219		

ILCO Number	Sec - Page(s)	ILCO Number	Sec - Page(s)	ILCO Number	Sec - Page(s)	ILCO Number	Sec - Page(s)
1123	2-273		2-245	1176RK	2-247	XO1199B	1-57
1123A	2-273	1137S	2-222	A1176	2-247	XO1199G	1-57
1123S	2-273	L1137	2-222	A1176KT	2-247	1206	6A-368
A1124	5-361	1140G	2-257	A1176ST	2-247,	1209	6A-368
1125	1-75, 2-242	1140P	2-257		2-271	1213A	6A-368
1125A	1-75,	1141	2-271	N1176	2-247,	1214	6A-366
	2-242,	1141E	2-271		2-273	1215A	6A-368
	2-245	1141F	2-271	S1176	2-247	1215B	6A-369
1125D	2-242	1145GE	2-271	1177	2-252	1217A	6A-369
1125F	1-75	1141K	2-271	1177A	2-252	1221AL	6A-367
1125G	1-76	1145	2-269	1177N	2-215,	1222AL	6A-369
1125H	1-76	1145A	2-215,		2-252	1222B	6A-369
1125K	1-76		2-269	1179	2-215,	1222E	6A-369
1125M	1-76	1145AST	2-271		2-217	1222L	6A-369
1125X	2-242	1145CE	2-269	1179A	2-217	O1223L	6A-367
D1125	1-76	1145E	2-269	1179SC	2-217	1224	6A-367
O1125NR	5-361	1145EF	2-269	A1179E	2-217	1224F	6A-367
1126M	1-76, 2-270	1145F	2-269	A1179F	2-217	1224L	6A-367
1127	1-76	1145FG	2-269	A1179G	2-217	1225A	6A-367
1127B	1-76	1145G	2-269	A1179H	2-217	1225E	6A-367
1127D	1-76	1145H	2-269	A1179J	2-217	1225PL	6A-368
1127DP	1-76	1145J	2-269	A1179K	2-217	1226	6A-369
1127DU	1-76	1145K	2-269	A1179L	2-217	1239	6A-369
1127ES	1-76	1145L	2-269	A1179N	2-217	1242	6A-370
1127F	1-76	A1145CE	2-269	A1179P	2-217	1242L	6A-370
1127FD	1-76	A1145E	2-269	A1179R	2-217	1243D	6A-370
1127FL	1-76	A1145EF	2-269	A1179S	2-217	SC1246	2-268
1127FR	1-77	A1145F	2-269	A1179T	2-217	SC1247	2-268
1127H	1-77	A1145FG	2-269	A1179U	2-217	SC1248	2-268
1127J	1-77	A1145G	2-269	A1179V	2-217	1262A	1-151
1127K	1-77	A1145H	2-269	B1179-1C	2-217	1270	6A-370
1127L	1-77	A1145J	2-269	B1179-1D	2-217	1270A	6A-370
1127M	1-77	A1145K	2-269	N1179	2-215,	1270B	6A-370
1127ME	1-77	A1145L	2-269		2-217	1270C	6A-370
1127MP	1-77	D1145A	2-232	N1179A	2-215,	1270D	6A-366
1127MU	1-77	DS1145	2-232		2-217	1270H	6A-370
1127N	1-77	DS1145BR	2-233	1181C	2-232	1271H	6A-370
1127P	1-77	K1145	2-215	1181FD	1-78	1286	6A-366
1127T	1-77	1146	2-257	S1181FD	1-78	1286B	6A-366
1127TB	1-77	1147	1-103,	1184FD	1-78, 1-145	1286BR	6A-366
M1127A	1-77		1-211,	1185FD	1-79	1286C	6A-366
P1127C	1-90		3-291, 6B-	1185T-P	1-79	1286E	6A-366
S1127C	1-90		374	S1185-P	1-79	N1286	6A-367
S1127FD	1-77	1148	1-122,	1186TS	1-79	N1286R	6A-367
S1127FL	1-78		1-211,	1186TS-P	1-79	R1286E	6A-366
S1127FR	1-78		6B-373, 6B-	S1186TS	1-79	1303	6A-370
S1127LC	1-78		374	S1186TS-P	1-79	1303S	6B-373
S1127ME	1-78	1154C	2-236,	1188LN-P	1-79	1306	6A-370
S1127MU	1-78		2-245	1190LN	1-79	1306A	6A-370
1130	2-216	1154G	2-245	1191ET	1-79	1307A	2-269
1130R	2-216	1167FD	1-78	1193FD	1-79	1307W	2-269
1131	2-216	S1167FD	1-78, 1-145	1193MU	1-80, 1-151	L1307A	2-269
1131R	2-216	1170	2-220	1195FD	1-81	L1307W	2-270
1132	2-280	1170B	2-220	1196CM	1-83	R1307A	2-269
H1132	2-280	1170C	2-220	1196FD	1-82	R1307W	2-270
1133	5-357	1170LN	1-78	1196V	1-82	1309	6A-370
1133A	5-357	A1170C	2-220	1199C	1-57	1321	6A-370
1134	5-357	S1170LN	1-78	1199D	1-57	1322S	6B-372
1135	5-357	1175	2-273	1199DR	1-57	1323	5-360
1136S	2-222	1176	2-234,	1199E	1-57	1323L	5-360
1137B	1-50, 1-55,		2-247,	X1199A	1-57	1326	6B-373
	1-105,		2-256	X1199AR	1-57	1332	6B-373
	2-215,	1175N	2-273	X1199B	1-57	1332S	6A-367
	2-222,	1176D	2-247,	X1199G	1-57	1333	5-357
	2-238,		2-256	X1199J	1-57	1334	5-357

INDEX

ILCO Number	Sec - Page(s)	ILCO Number	Sec - Page(s)	ILCO Number	Sec - Page(s)	ILCO Number	Sec - Page(s)
1335S	5-357, 5-360	1533	2-235	1591M	1-65	1653	2-216
SC1340	2-268	1534	2-270	1591N	1-65	1654	2-247
SC1347	2-268	1536	1-191,	1591P	1-65	1655	2-252
1360G	5-357, 5-361	1536R	2-242	1592	1-91	1656	1-131
1362	5-357, 5-361	1537	1-191,	1594	2-220	1657	1-131
1365	5-356	1538	2-242	1595	1-52	1659	2-220
1366	6A-370	1539	2-246	1596	1-153	1659R	2-220
SC1368	2-268	1540	2-242,	1597	2-240	1660	1-91
1387	5-357, 5-361	1541	2-246	1598	2-240	1661	2-220
1387G	5-358, 5-361	1542	1-134	1599	2-240	1662	2-274
1388	5-358, 5-362	1543	1-135	1600	2-240	1663	2-247
1388L	5-358, 5-362	1544	2-246,	1601	2-272	1664	1-56
1389G	5-362	1545	2-271	1602	2-272	1665	2-272
1390	5-362	1546	2-251,	1603	2-272	1666	2-272
1390G	5-362	1550	4-309	1604	2-272	1667	2-272
1396S	5-358	1551	2-251,	1605	1-191	1668	2-257
1412	6A-366	1552	4-309	1606	2-272	1669	2-220
1416	6B-372	1555	2-255	1607	2-272	1670	2-240
1417	6A-366	1555-NS	2-255	1608	2-272	1671	2-238,
1417A	6A-366	P1555	1-92	1609	2-272	1674	2-241
1418	6A-367	P1555-NS	2-220	1610	2-272	1675	2-274
1422	6A-368	1556	2-238	1611	1-92	1676	2-217
1425	6A-367	1557	2-238	1611R	1-92	1677	2-218
1427	6A-368	1558	4-308	1612	2-272	1678	2-235
1430	6B-372	1559	4-308	1615	2-249	1679	2-238
SC1456	2-268	1560	4-308	1616	2-274	1679R	3-291
SC1460	2-268	1561	2-236	1617	2-238	1681	2-238
SC1467	2-268	1562	1-191	1618	2-218	1682	2-239
SC1468	2-268	1563	2-220	1618R	2-218	1683	2-240
1502	2-236	1564	2-270	1621	1-191	1686	2-220,
1502M	2-236	1565	1-56	1622	2-272	1687	2-274
1503	2-236	1566	1-52, 2-241	1623	2-272	1688	2-254
1510	2-217	1567	2-241	1624	2-271	1689	2-236
1511	2-217	1568	2-241	1626	2-270	1689R	3-291
1515	2-251, 4-308	1569	2-241	1627	1-180	1692	3-291
A1515	2-251, 4-308	1570	1-191	1628-P	1-91	1694	2-255
1516	3-288	1571	2-270	1629-P	1-91	1695	1-134
1517	2-251, 4-308	1573A	1-91	1630-P	1-183	1696	1-134
A1517	2-251, 4-309	1573B	1-91	1631	2-220	1701G	1-57
1518	2-251, 4-309	1573C	2-242	1632	2-220	1702K	1-57
1519	1-134	1573D	4-308	1633	2-220	1703K	1-57
1521	2-235	1573E	4-308	1634	2-274	1704K	1-58
1523	3-299	1573F	4-308	1635J	2-216	1705K	1-58
1524	1-103, 1-172	1574	1-65	1635K	2-216	1706K	1-58
1525	2-241	1574R	1-65	1635L	2-216	1709P	1-58
1526	5-358, 5-360	KB1577G	1-65	1635V	2-216	D1759L	1-58
1527	1-191	P1577E-NS	1-65	1636	2-216	1761LS	1-80
1528	2-246	1581G	1-92, 2-242	1637	2-271	1761MP	1-80
1528R	2-246	1581H	2-242	1638	2-270	1761MS	1-80
1529	1-191	1583	4-308	1638	2-252	1764P	1-58
1531	2-236	1584	4-308	1639	2-252	1764S	1-58
		1585	1-65	1640	2-248	1766DT	1-58
		1587	1-65	1641	2-248	1766LN	1-80
		1588	1-56, 1-155	1642	1-56	1766S	1-58
		1589I	1-91	1643	2-270	S1766LN	1-80
		1589J	1-91	1644	2-252	1767CH	1-58
		1589K	2-248	1645	2-252	1768CH	1-58
		1590K	2-280,	1645R	2-238	S1768CH	1-58
		1591L	5-363	1646R	2-239	1769CH	1-58
			1-91	1648	2-273	1770CH	1-58
			1-91	1649	2-218	P1770U	1-59
			1-65	1650	2-247		
			1-65	1651	2-272		
			1-65	1652	2-217		

ILCO Number	Sec - Page(s)	ILCO Number	Sec - Page(s)	ILCO Number	Sec - Page(s)	ILCO Number	Sec - Page(s)
S1770U	1-59						
U1770CH	1-59						
P1771CR	1-60, 1-179, 1-186						
S1771CR	1-60, 1-179						
P1786	1-59						
P1789	1-59						
P1790TC	1-61						
1793V	1-59						
P1793	1-59						
1794V	1-59						
P1794	1-59						
P1795	1-59						
1866-DO3	2-235						
1866-4	2-257						
1866-7	2-257						
1866-10	2-257						
1866-13	2-257						
1970AM	1-42						
S1970AM	1-42						
K1994	1-131, 1-165						
K1995	1-131						
2712	6B-372						
2714	6B-372						
3916-22	6B-374						
4015	5-360						
4295	4-309						
5981R-NS	4-309						
6275LA-NS	4-309						
6750	7-381						
01022	2-270						
07743	4-308						
08260KW	4-308						
9114	4-310						
10119-001	4-306						
9278	4-310						
12344-BR	4-310						
12344-NS	4-310						
83559	4-310						
320433	4-310						
320514	4-310						
320560	4-310						
320561	4-310						

INDEX









SECTION 1 VEHICLE KEYS

Key blanks for automobiles, motorcycles, airplanes, boats, garden tractors, etc., designed and manufactured worldwide. The manufacturers are listed in alphabetical order with keys listed in numerical sequences where possible.

There are several symbols and suffixes used in this section. Below is a legend of their use.

-  Transponder Key
-  Electronic Key
-  Special Key Machine Required
-  Cloning Tool Required
- P Plastic Key Head
- PC Color Plastic Head Key
- P (-PC) Available with Black or Color Plastic Head

ACURA



VEHICLE KEYS

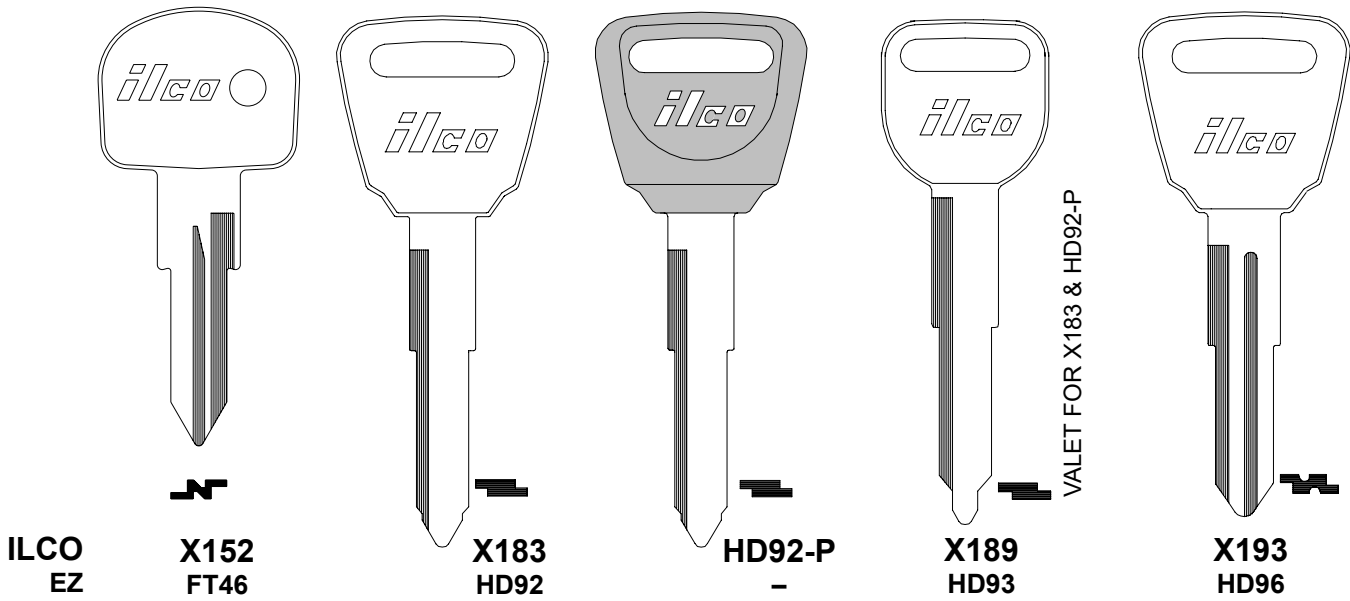

ACURA

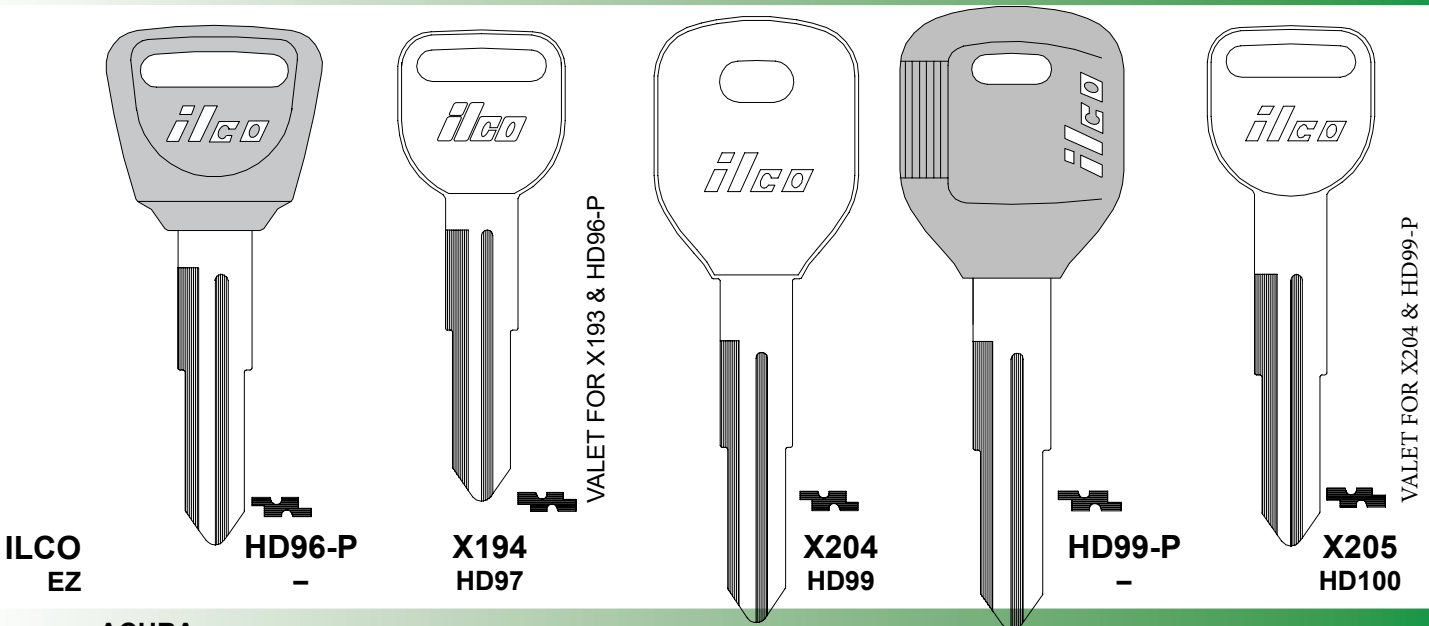

ACURA

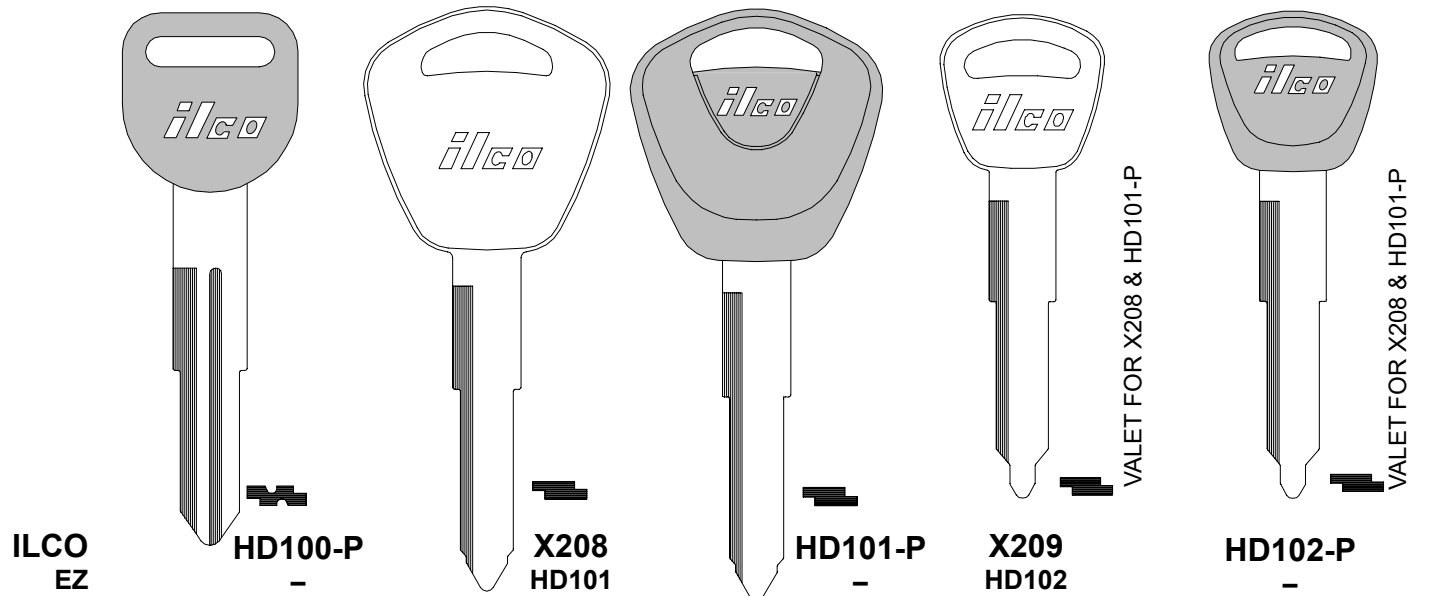



ACURA



HD111-PT
-

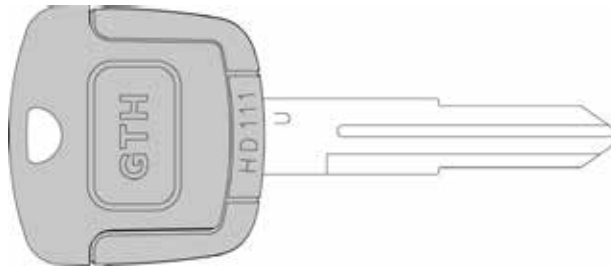

HD111-GTK
(Complete Key)



GTH
(Head Only)

EB3-U-HD111
(Blade Only)

ILCO
EZ

ACURA

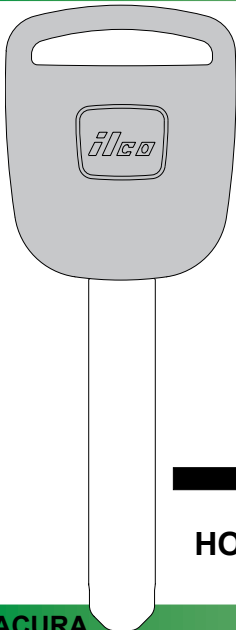

HO03-PT
-

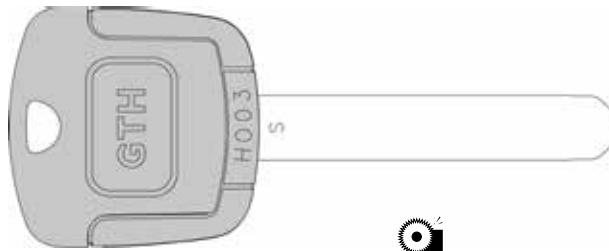

HO03-GTK
(Complete Key)



GTH
(Head Only)

EB3-S-HD111
(Blade Only)

ILCO
EZ

ACURA

ALFA ROMEO

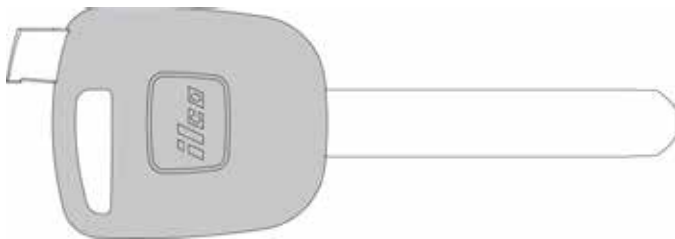

HO03-GTS
-



SP25A
-



FS1
-



ILCO
EZ

VEHICLE KEYS

ALFA ROMEO

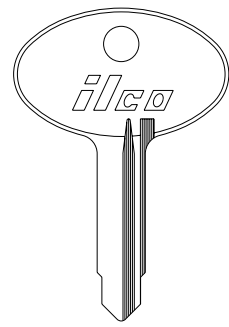
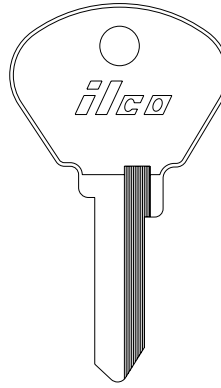
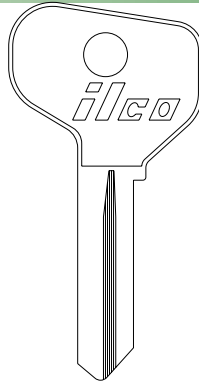
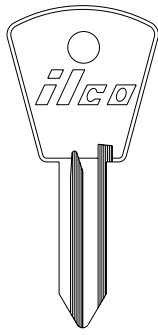
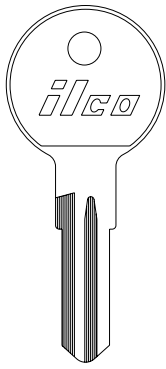

R61D

-

61E

-

61TS

-

R61TS

-

ILCO
EZ

F29
-

F33
-

FT37
-

FT38
-

FT44
-

61D
-

ALFA ROMEO

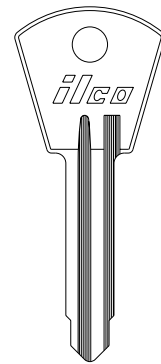
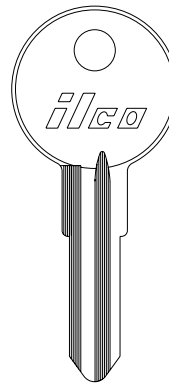
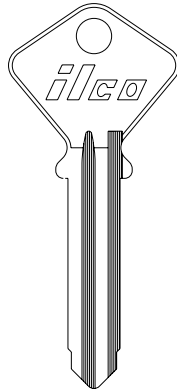
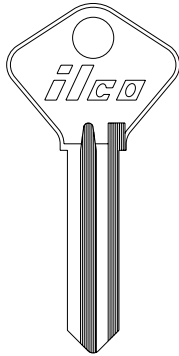
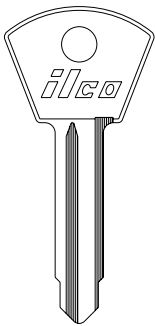

L61D

-

LR61D

-

ILCO
EZ

61F
-

61G
-

R61G
HD99

61GA
-

R61GA
-

61H
-

R61H
-

H61G
-

ALFA ROMEO

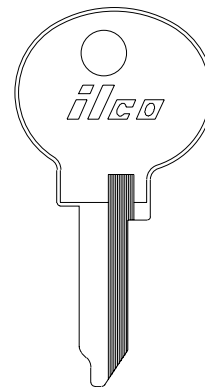
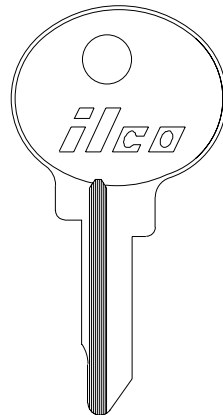
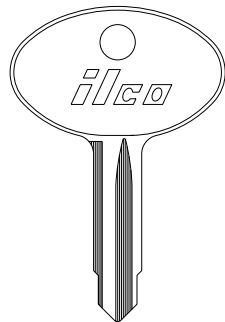
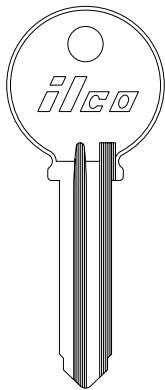

RE61XR

-

62DG

-

R62DG

-

ILCO
EZ

L61G
-

LR61G
-

R61ST
-

R62TS
-

RE61N
-

RE61XR
-

62DG
-

R62DG
-



ALFA ROMEO



KL1
-



SP1
-



SP2
-



AL3
-



F38



F39



F40



F41
-

ILCO
EZ

VEHICLE KEYS

ALFA ROMEO



SF7AF
-

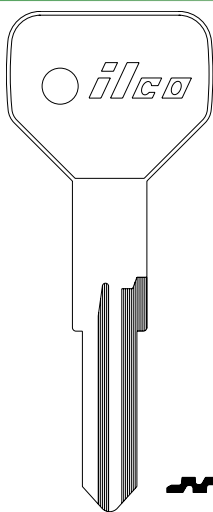

SF8
-



X166
FT48



SF9
-

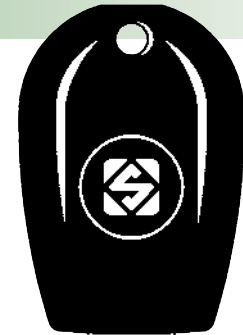

SP9
-

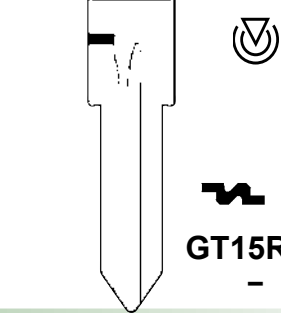

GT15RT2 ILCO
EZ

ALFA ROMEO

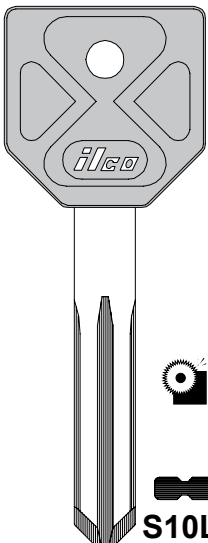

S10LAA-P
-

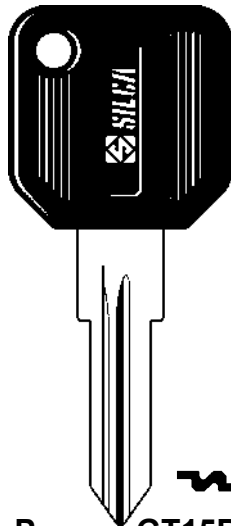

GT15RAP
-

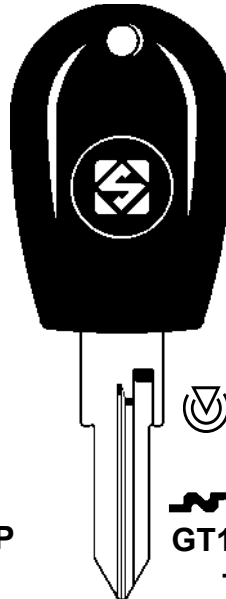

GT16T2
-

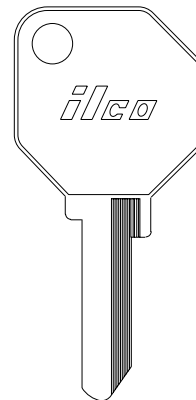

NE23
-

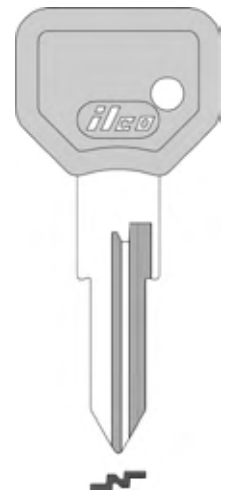

SP25A-P
-

ILCO
EZ

ALFA ROMEO

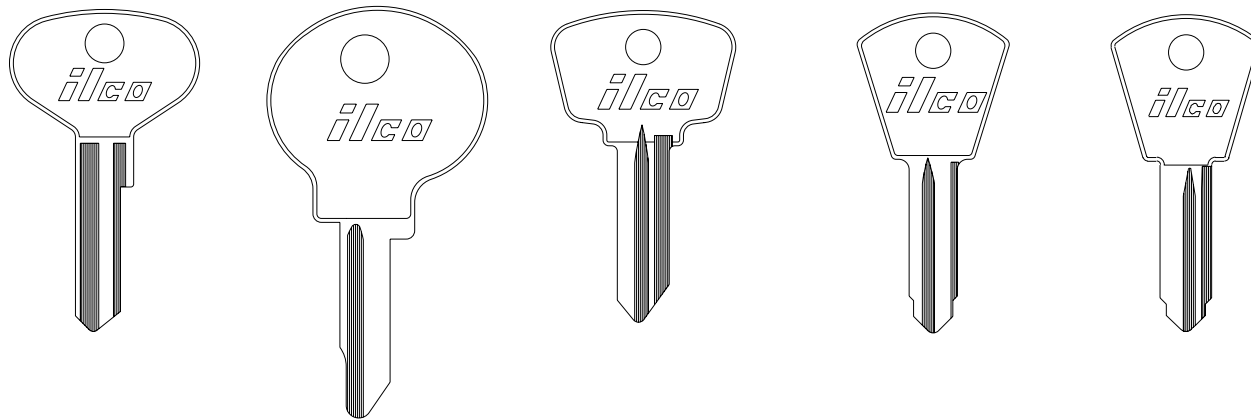

ILCO	HR62DG	63M	63SP	R63SP	63ST	R63ST	R63TS
EZ	-	-	-	-	-	-	-

ALFA ROMEO

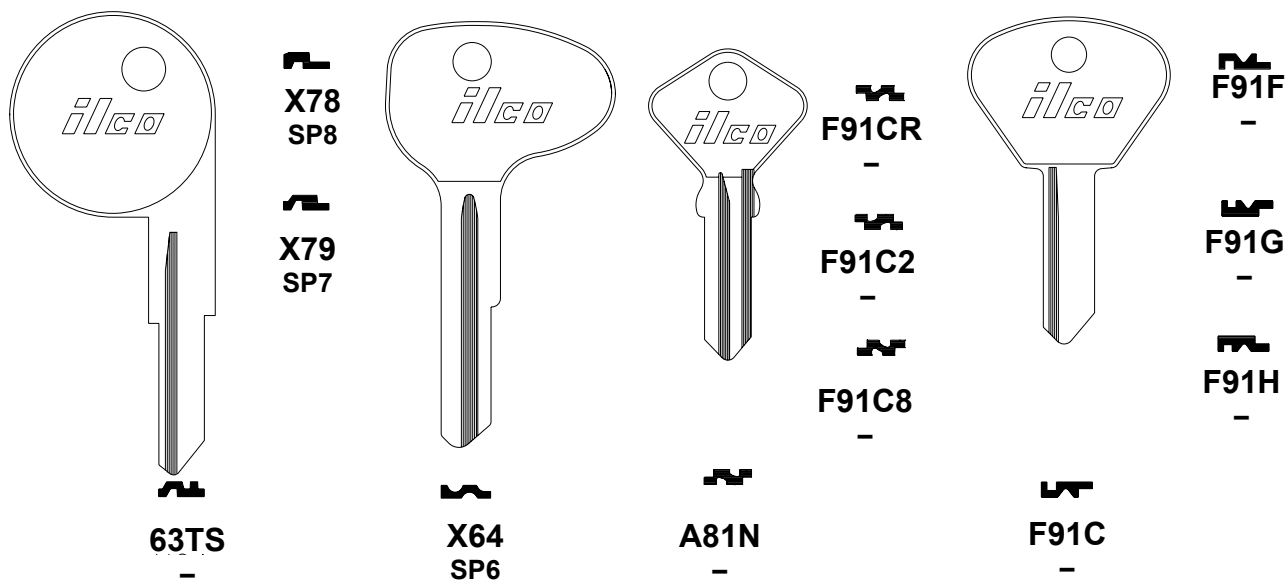

	X78 SP8			F91CR		F91F
	X79 SP7			F91C2		F91G
				F91C8		F91H
ILCO	63TS	X64 SP6	A81N	F91C		
EZ	-	-	-	-	-	-

ALFA ROMEO

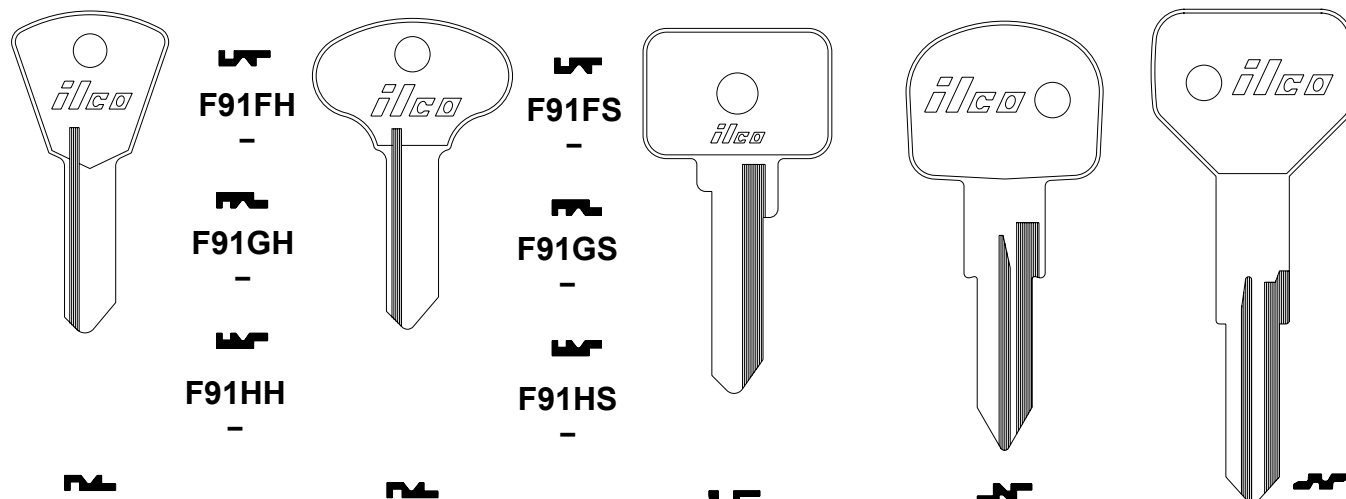

	F91FH	F91FS			
	F91GH	F91GS			
	F91HH	F91HS			
ILCO	F91E	F91EH	F91ES	X109	X152
EZ	-	-	-	FT43	FT46





AMERICAN MOTORS / JEEP / RENAULT

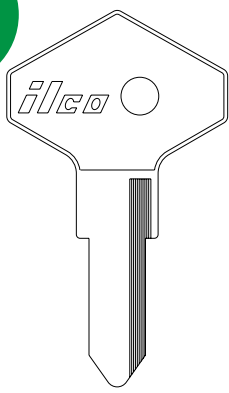

X85
NE36

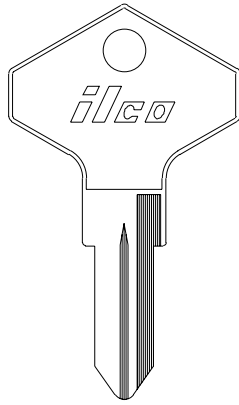

X92
RN25



X116
RN24

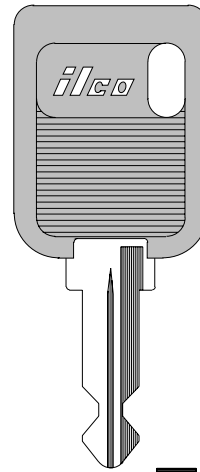

RN24-P
-

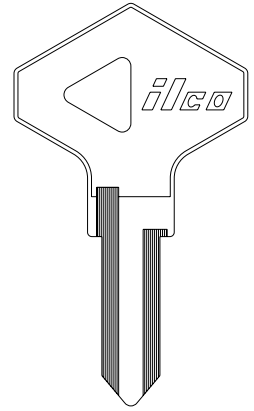

X122
RN29

ILCO
EZ

VEHICLE KEYS

AMERICAN MOTORS / JEEP / RENAULT

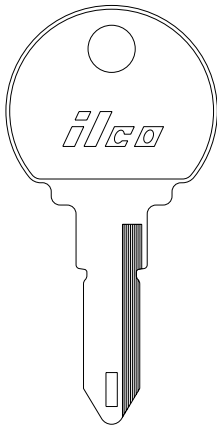

X147
RN30

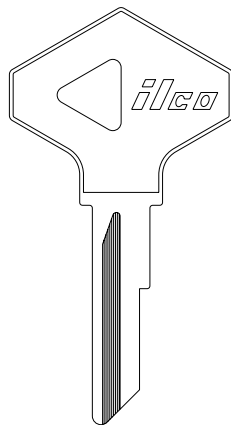

X150
RN27

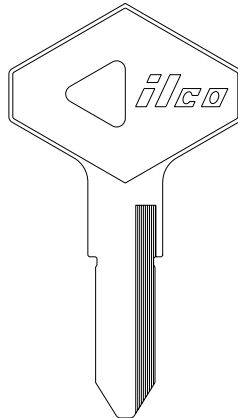

X171
RN31

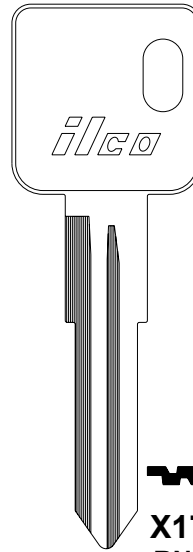

X175
RN32

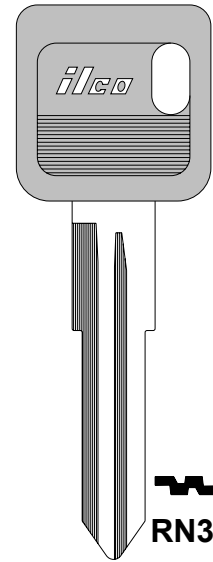

RN32-P ILCO
- EZ

AMERICAN MOTORS / JEEP / RENAULT

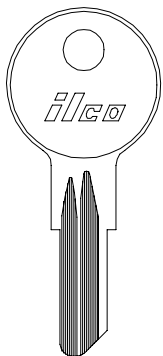

1098DB
B5

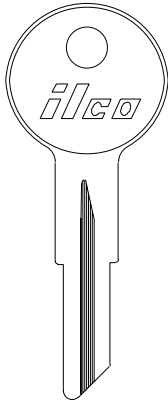

1098NR
RA1

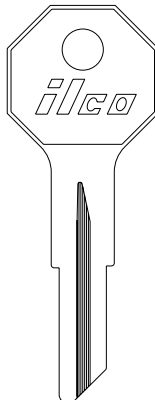

H1098NR
RA2

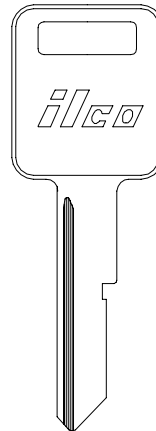

P1098J
B46

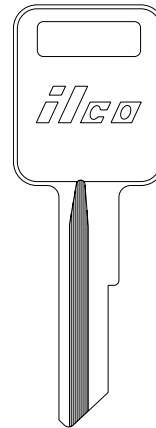

1970AM
RA4

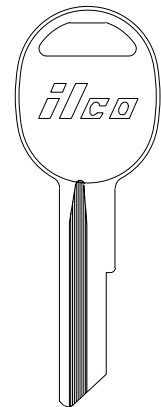

S1970AM
RA3

ILCO
EZ



ARTIC CAT

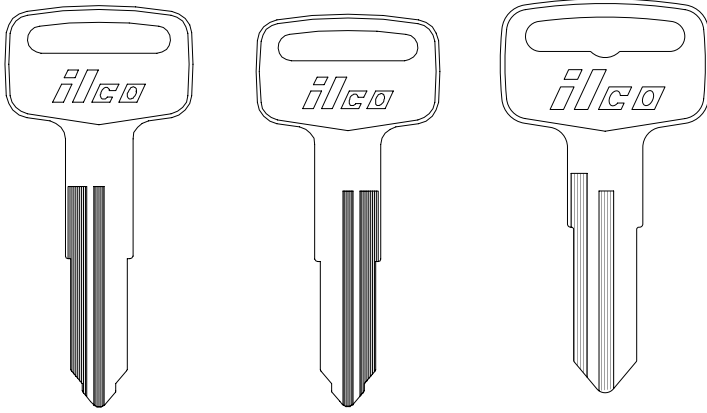

ILCO EZ X117 YH48 X118 YH49 X72 YH36

APRILIA

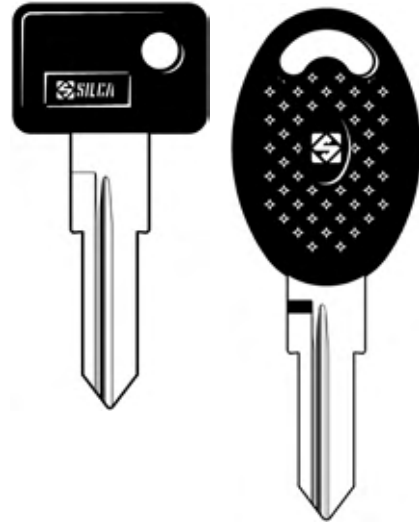

ZD16RP-SI - ZD22RBP-SI -



APRILIA

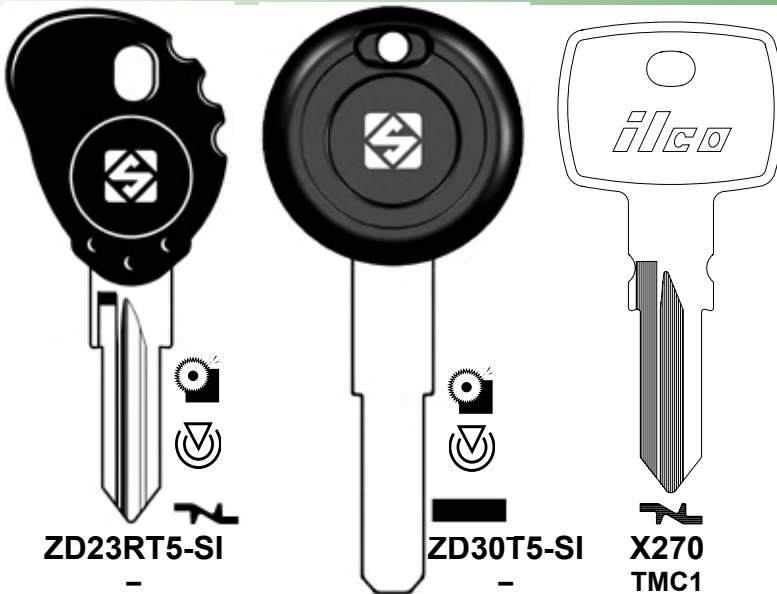

ILCO EZ ZD23RT5-SI - ZD30T5-SI - X270 TMC1

ARIEL

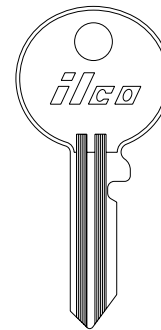

R62DH -

ASTON MARTIN

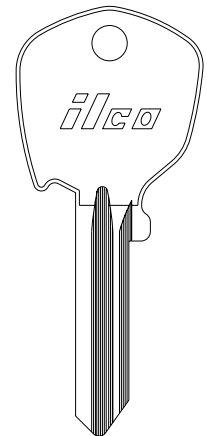

FT6R F81E

ASTON MARTIN

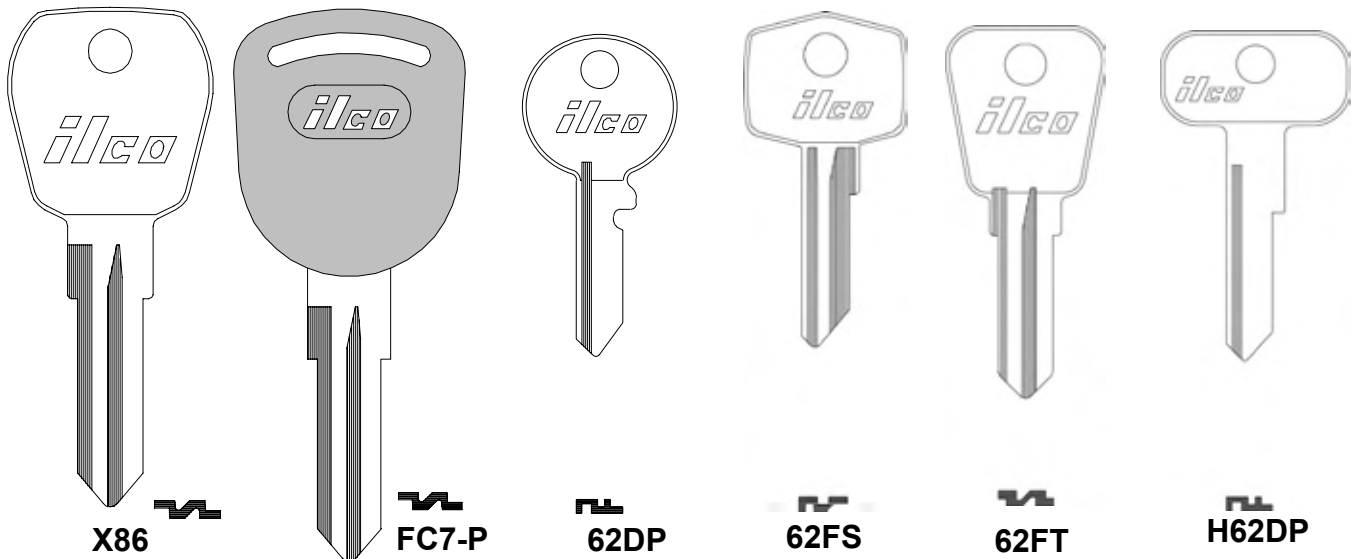

ILCO EZ X86 FC7 FC7-P - 62DP - 62FS - 62FT F68YT H62DP -

VEHICLE KEYS





ATALA

AUDI



ZD16RP-SI

-



AD1

-



PR1

-



PA5

-



WT5 ILCO

- EZ

AUDI

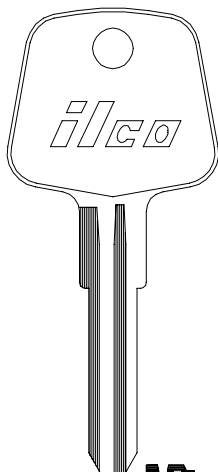

PA6

-

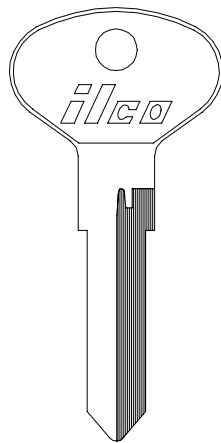

X9

73VB

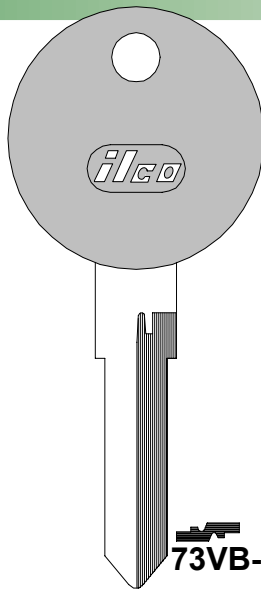

73VB-P

-

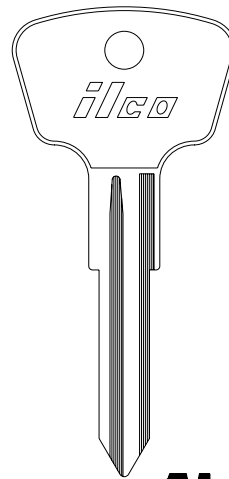

AU15

-

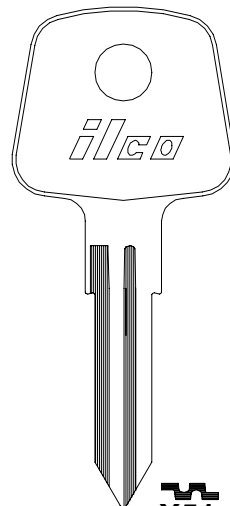

X51 ILCO

AA2 EZ

AUDI

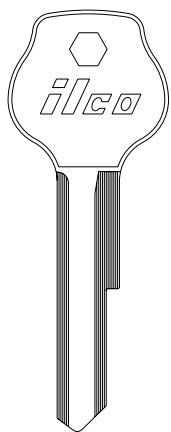

R62WA

-

AUDS2

-

62WB

-

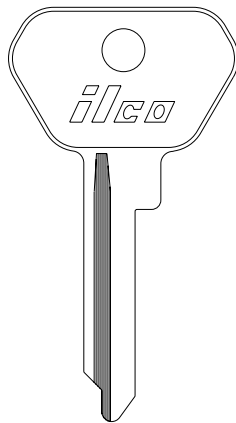

VO62

-

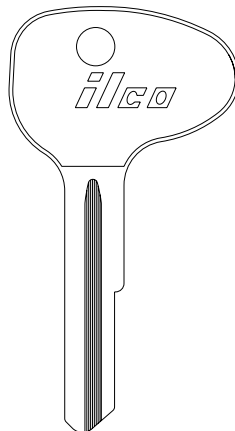

A81N

-

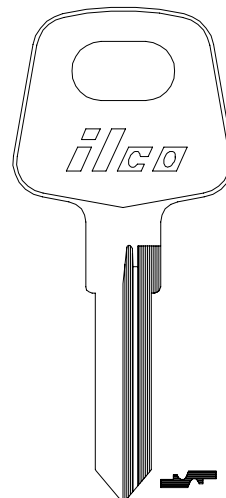

X88

PA8

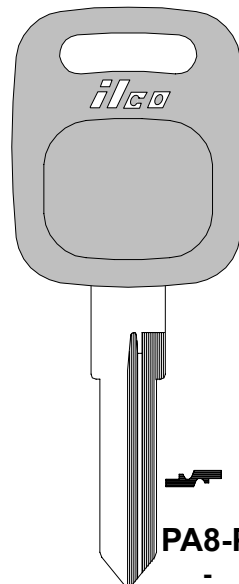

PA8-P ILCO

- EZ

VEHICLE KEYS

SEC 1
PG 44



AUDI

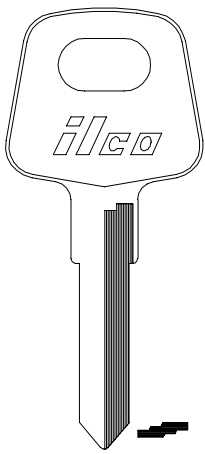

ILCO
EZ

X139
V35

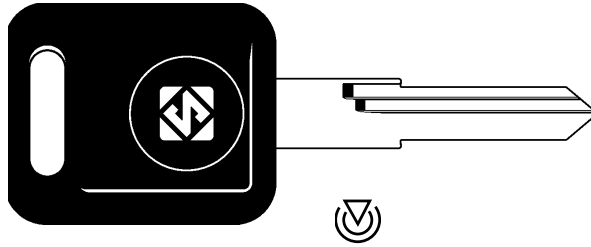

HU49AT2/5

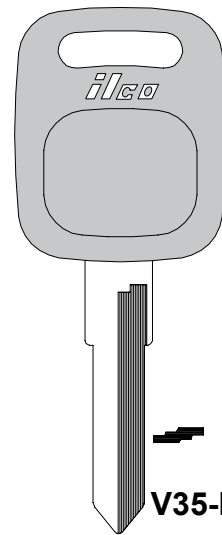

V35-P

AUDI

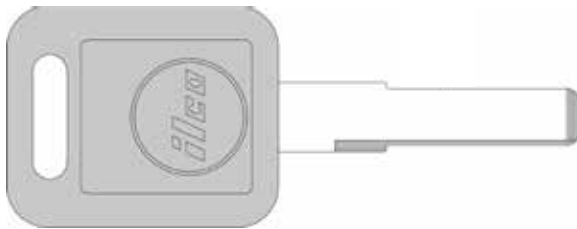

ILCO
EZ

HU66A-P

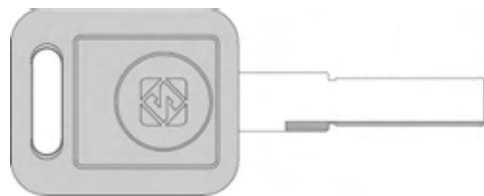

HU66AT2



HU66AT5/6

AUSTIN

AUTOBIANCHI

SEE
BRITISH
LEYLAND

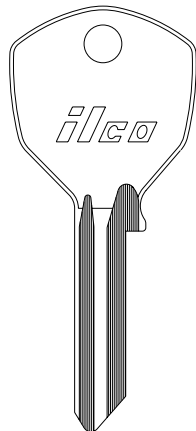

DM20



FT37 FT38

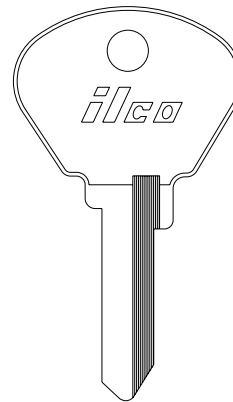

F44

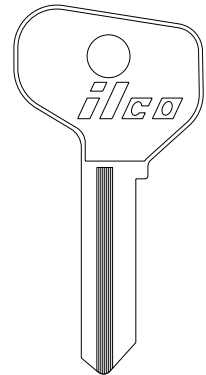

F54

ILCO
EZ





AUTOBIANCHI

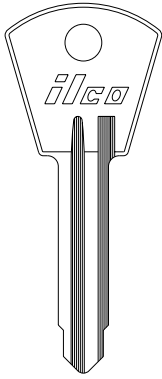

L61D

-



LR61D

-



SP5

-



H61G

-

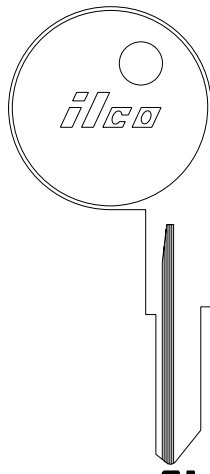

X64
SP6

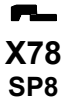

X78
SP8

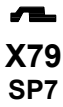

X79
SP7

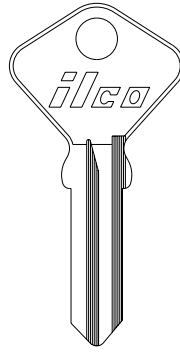

F91C

-



F91CR

-



F91C2

-



F91C8

-

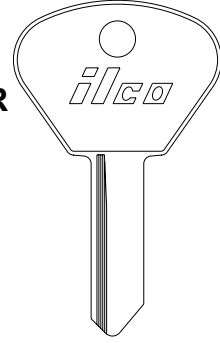

F91F

-



F91G

-



F91H

-



F91E

-

ILCO
EZ

VEHICLE KEYS

AUTOBIANCHI

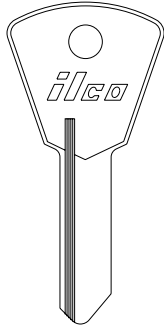

F91FH

-

F91GH

-

F91HH

-



F91EH

-

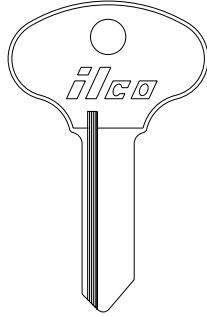

F91FS

-

F91GS

-

F91HS

-



F91ES

-

BARRI-LOCK

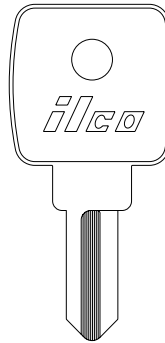

X56

-

BASTA LOCK

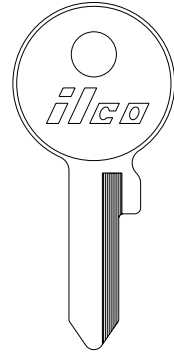

NE30

-

ILCO
EZ

BEDFORD

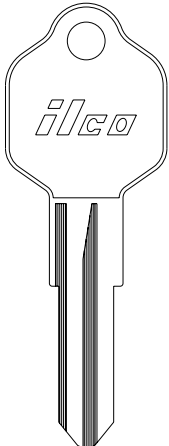

CE3

-

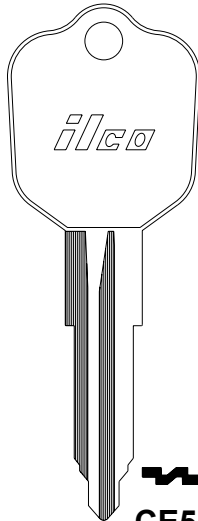

CE5

-

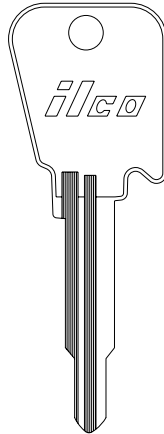

X13
LF4

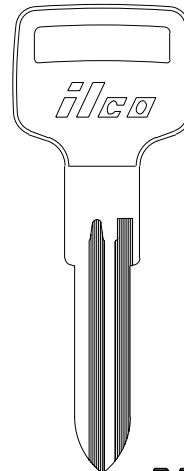

X29
VO73

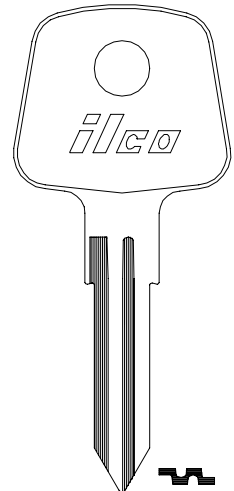

X51
AA2

ILCO
EZ

BEDFORD

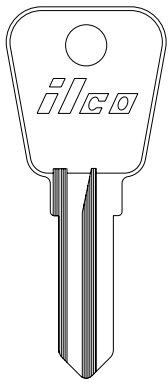

ILCO EZ 62FT F68YT

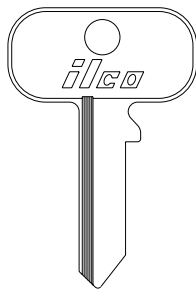

B62DP B62DR

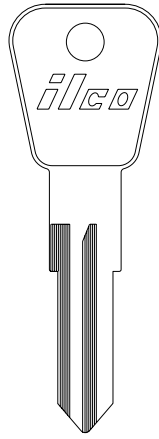

L62FD

BENTLEY

SEE ROLLS ROYCE

BETA

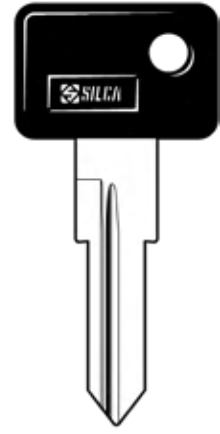

ZD16RP-SI



BIMOTA



ILCO EZ ZD23RCP



ZD24RDP-SI

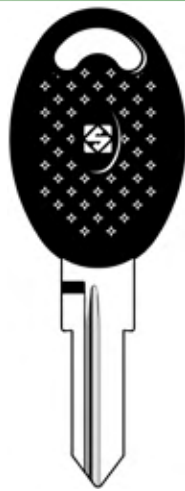

ZD22RBP-SI

BMW

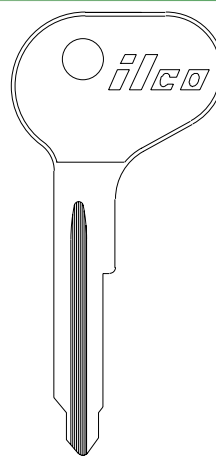

BMW1

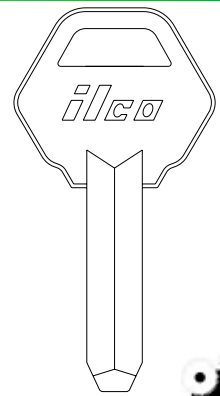

KS1

BMW

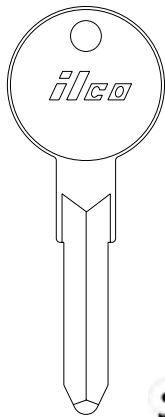

ILCO EZ PE1

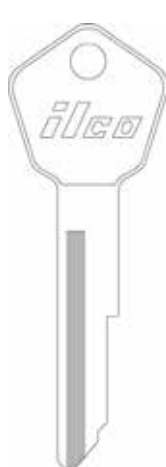

WT3

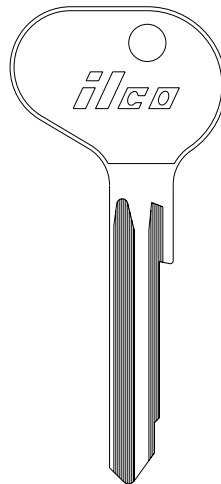

KL4

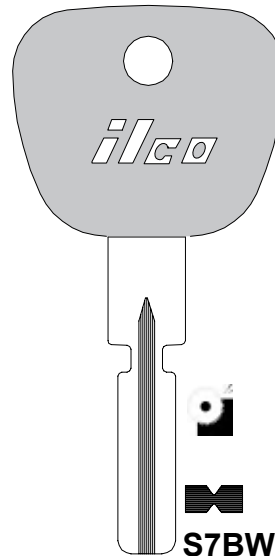

S7BW-P HD101

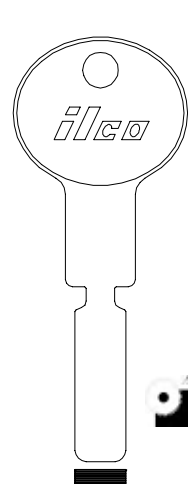

S6BW

VALET FOR S7BW-P



VEHICLE KEYS



BMW

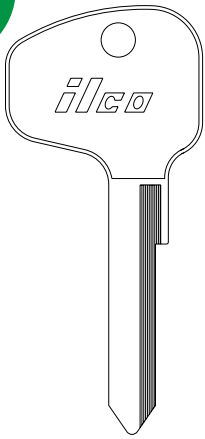

NE8
-

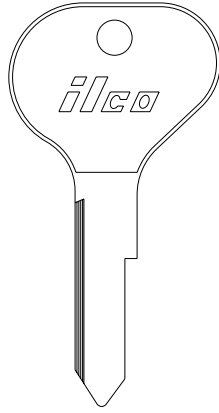

HF20
-

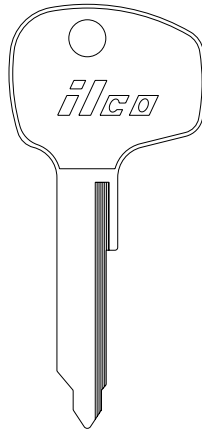

HF26
-

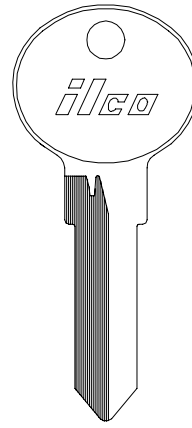

**X59
BMW2**



BMW2-P **ILCO
EZ**
-

VEHICLE KEYS

BMW

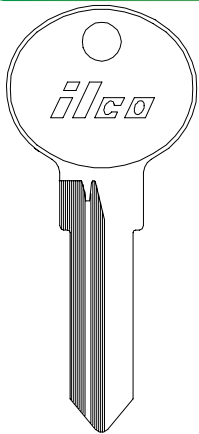

HF40
-

VALET FOR X59 & BMW2-P

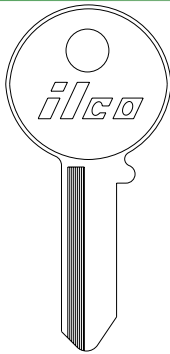

61N
-

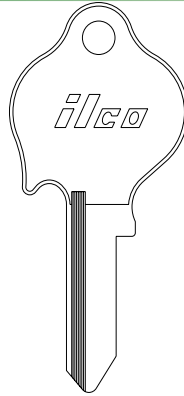

H61VM
-

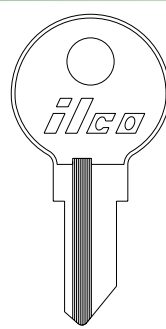

62VO
-

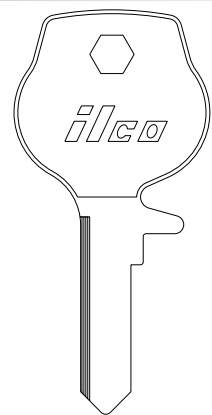

X62VK **ILCO
EZ**
-

BMW

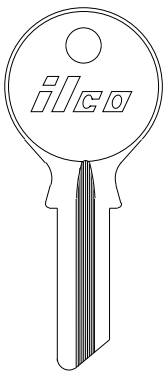

63L
-

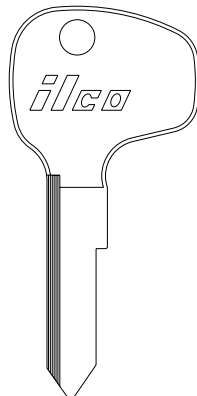

63VP
-

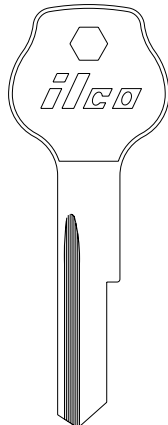

63Y



R63Y
-

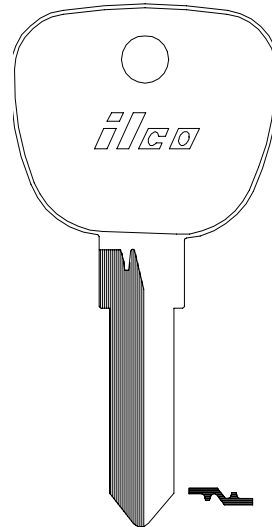

**X144
BMW3**

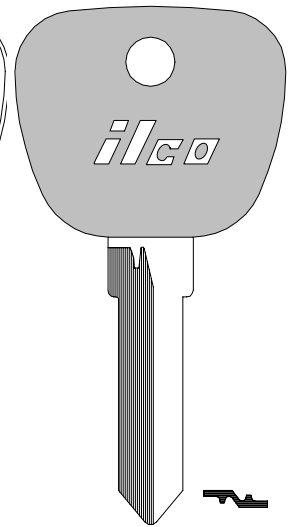

BMW3-P **ILCO
EZ**
-

SEC
1
PG
48



BMW

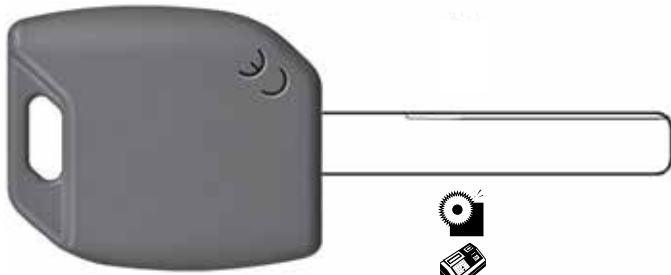

ILCO
EZ
HU92RMH
-

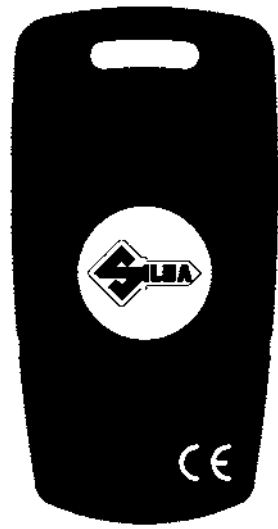

ILCO
EZ
HU92RMHK
-

BMW

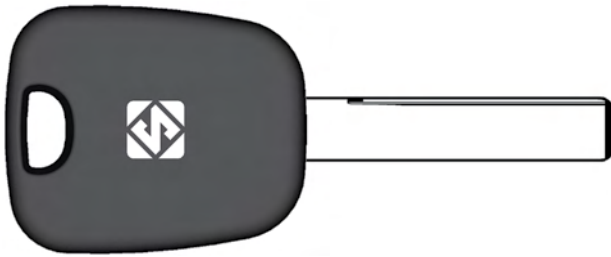

ILCO
EZ
HU92R-GTS
-



HU92RBMW
-

BMW

BMW MOTORCYCLE



ILCO
EZ
HU100BMW
-

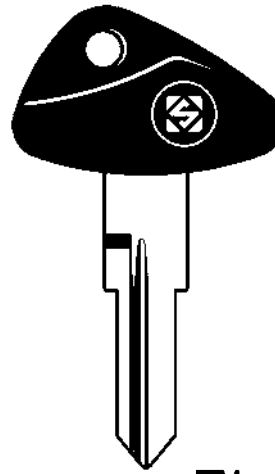

ZD28RFP-SI
-



X270
TMC1





BMW MOTORCYCLE

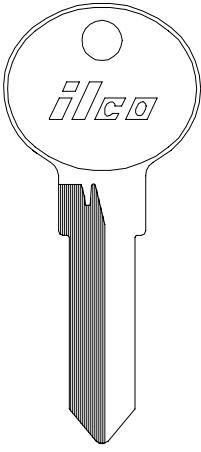

X59
BMW2

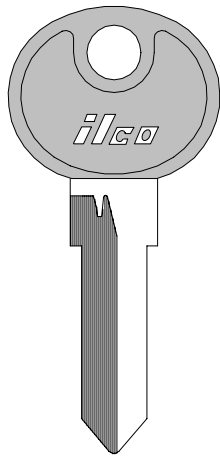

BMW2-P
-

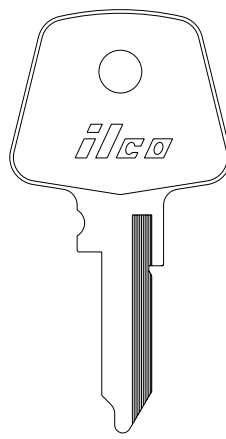

Y16
-

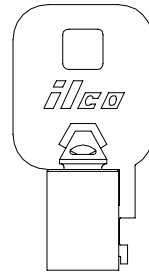

OD .377" - 0.6mm
ID .312" - 7.9MM
(BRASS)

1137B
-

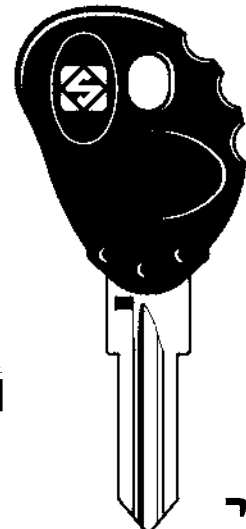

ZD23RCP-SI
-

ILCO
EZ

VEHICLE KEYS

BMW MOTORCYCLE

BOMBARDIER

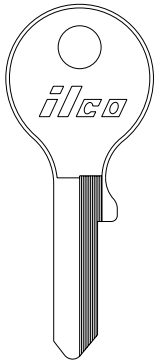

N2M
-

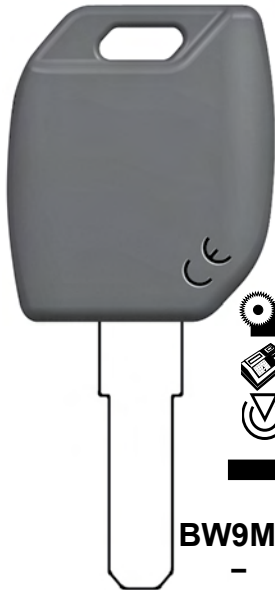

BW9MH
-

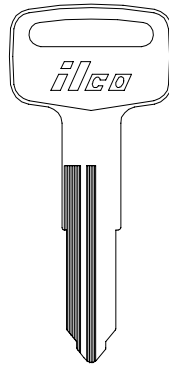

X117
YH48

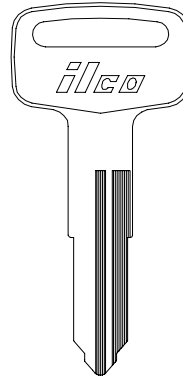

X118
YH49

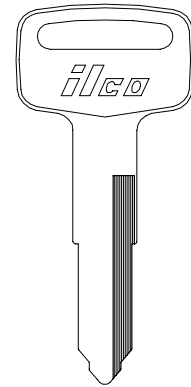

X119
YH47

ILCO
EZ

BOMBARDIER

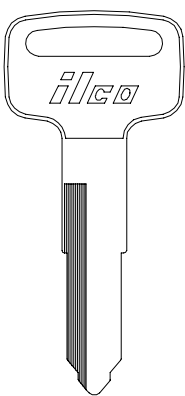

X120
YH46

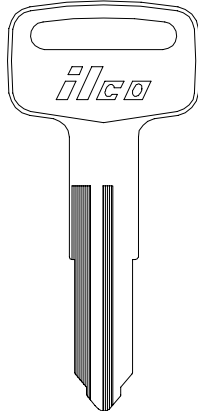

YH50
-

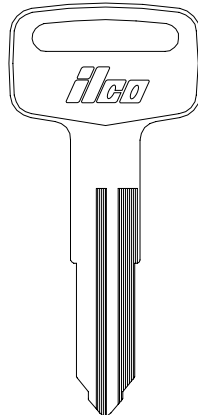

YH51
-

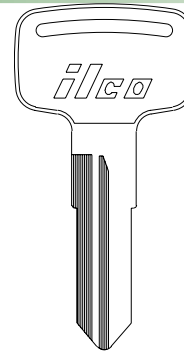

X111
YM55

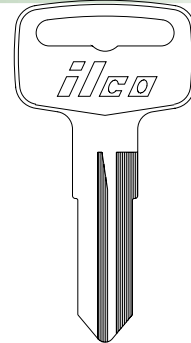

X112
YM56

ILCO
EZ

BORGWARD

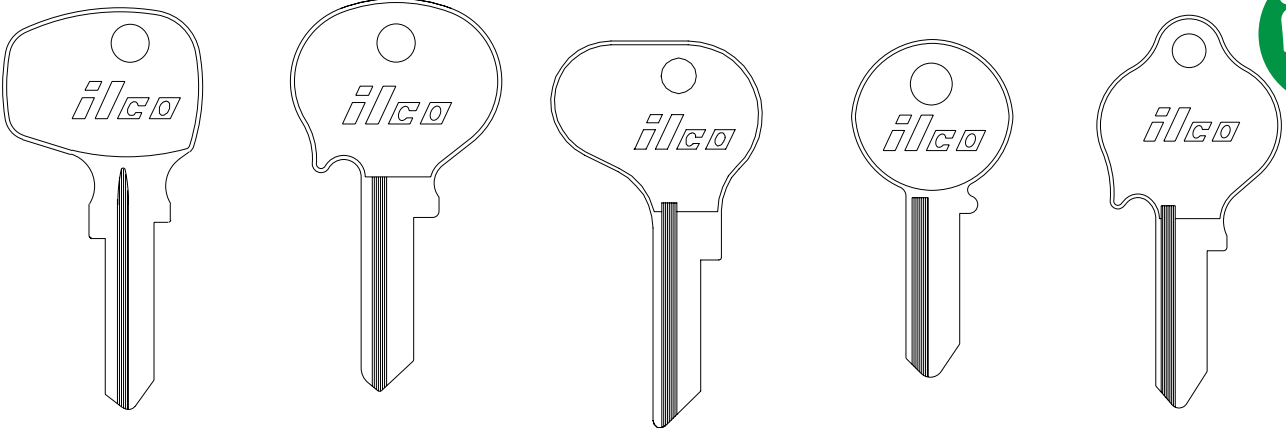

ILCO EZ	 MB5 -	 NE5 -	 NE10 -	 61N -	 H61VM -
------------	---	---	--	---	---

BORGWARD

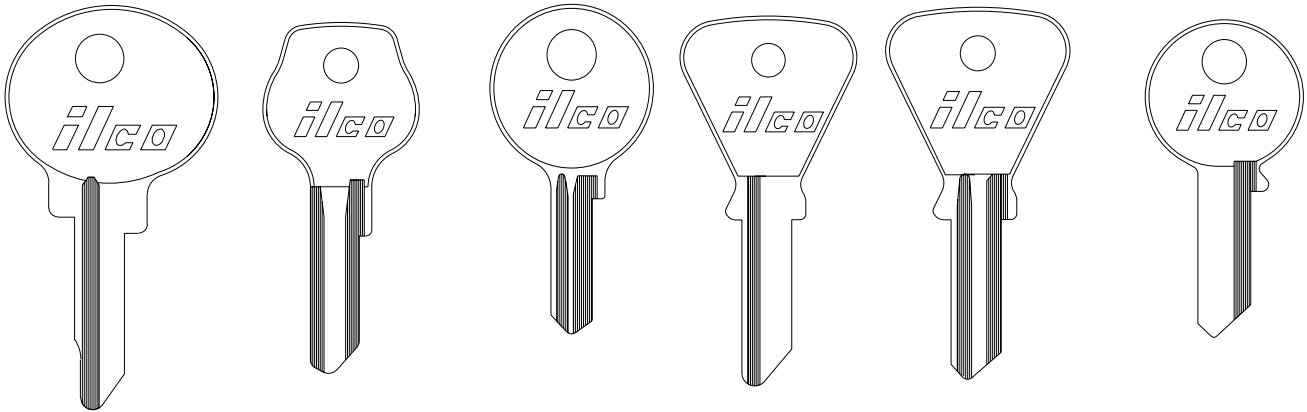

ILCO EZ	 RE61N -	 62VB	 R62VB -	 62VG -	 62VH	 H62VG	 HR62VG	 63F -
------------	---	---	---	--	---	--	---	---

BORGWARD

BOSCH

B & S / STRATTEC

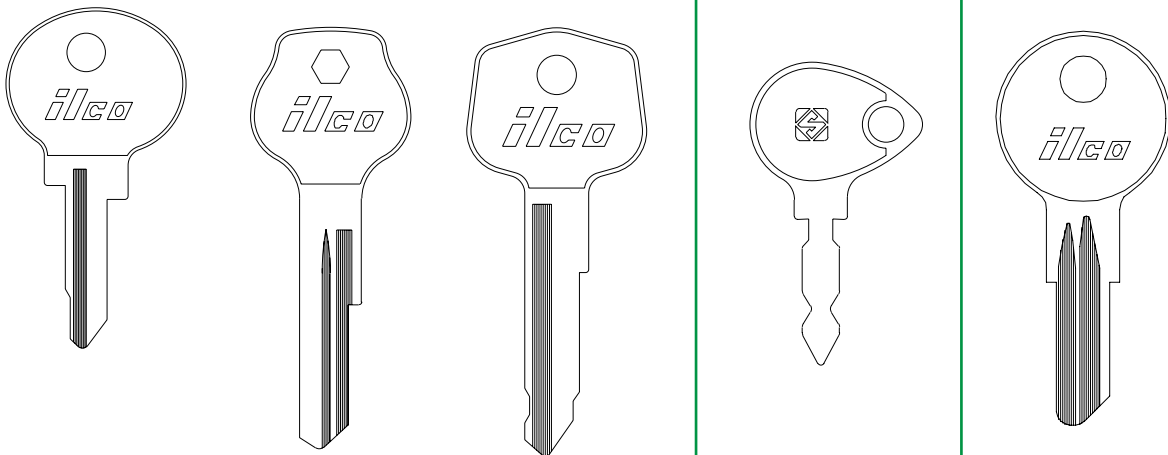

ILCO EZ	 63Q -	 R63Y -	 65M -	 BH12-SI -	 1098L B3	 1098X -
					 1098DB B5	





BRITISH LEYLAND

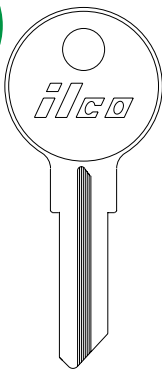

1561
-

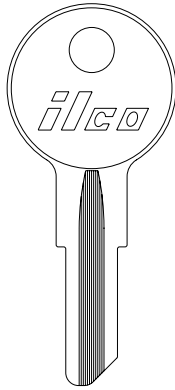

1098GM
-

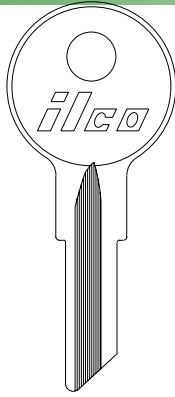

1098M
B1

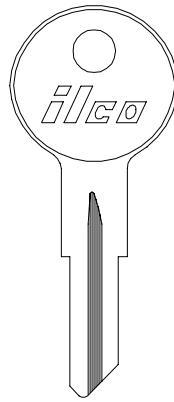

1098XL
B4

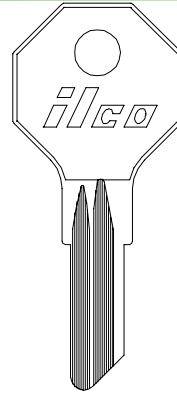

H1098DB
B16

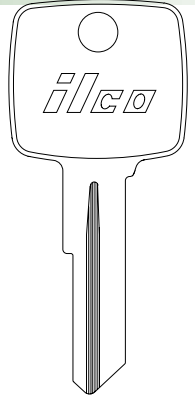

1595
- ILCO
EZ

BRITISH LEYLAND

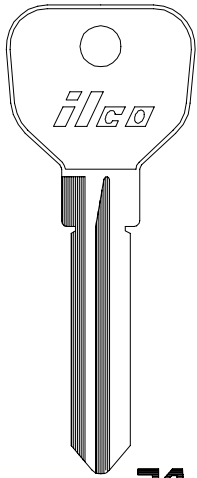

MG1
-

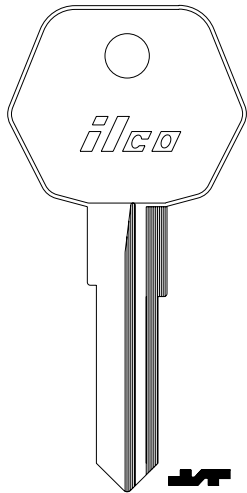

WB2
-

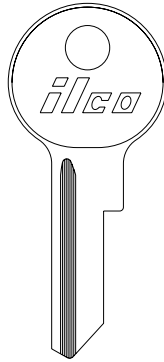

NE4
-

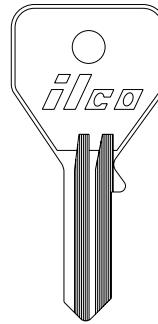

BR5
-

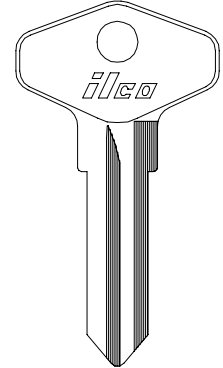

BL6
-

ILCO
EZ

BRITISH LEYLAND

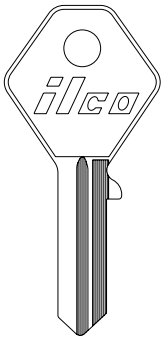

BR6
-

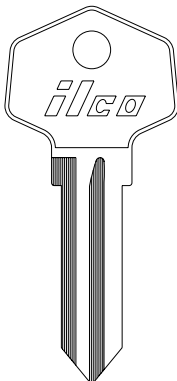

CE6
-

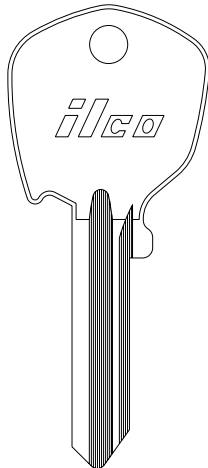

FT6
-

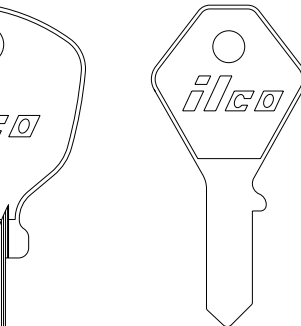

FT6R
F81E

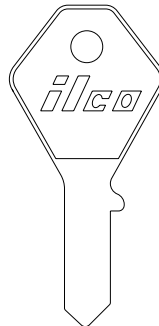

BR7
-

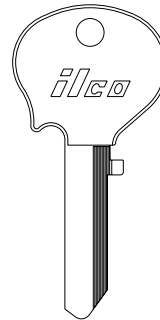

NE7
-

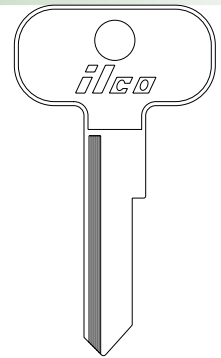

BR9
-

ILCO
EZ

VEHICLE KEYS

BRITISH LEYLAND

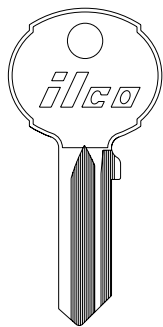

ILCO
EZ
BR13
-

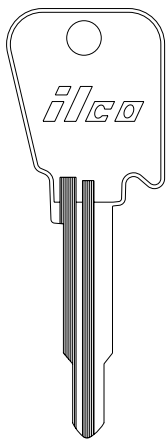

X13
LF4

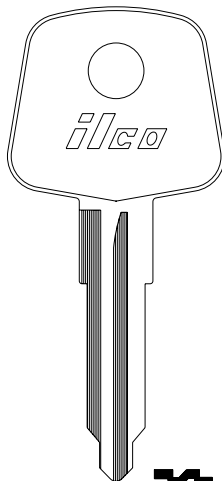

LF15
-

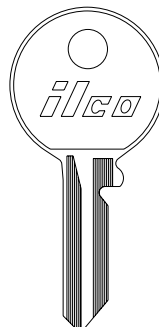

BR16
-



UN16
-

BRITISH LEYLAND

VEHICLE KEYS

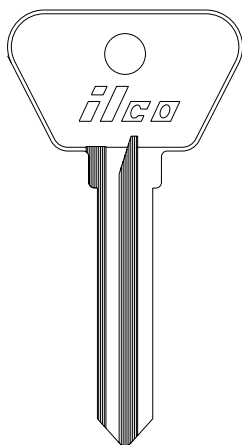

ILCO
EZ
BR20
-

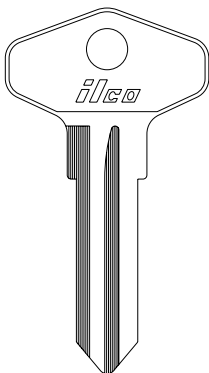

X20
FC2

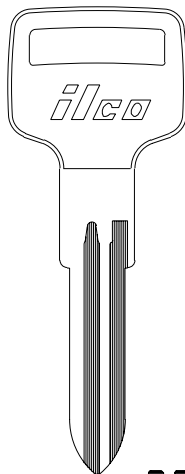

X29
VO73

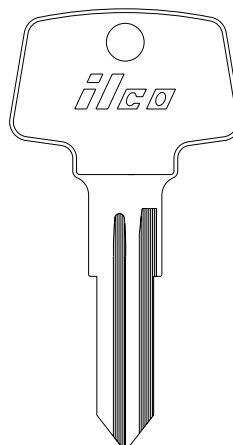

NE49
-

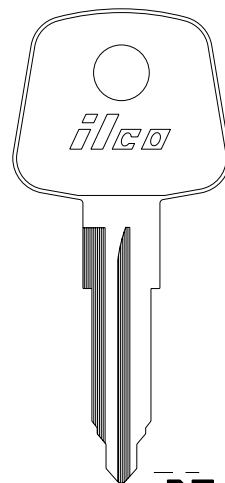

X50
AA3



LF13
-

BRITISH LEYLAND

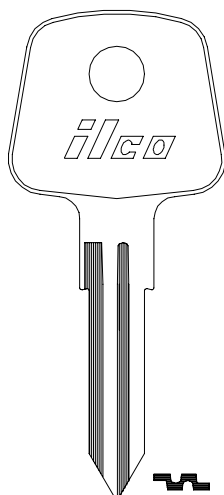

ILCO
EZ
X51
AA2

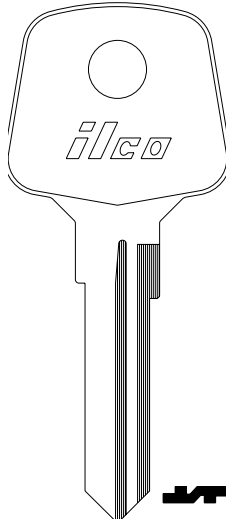

X55
WB1

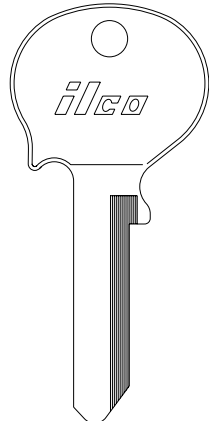

H61VR
-



62DE
-

62DF
-

62DG
-

62DC
-

62DH
-

62DK
-

62DM
-

R62DM
-

62DP
-

F70S
-

M72F
-



BRITISH LEYLAND

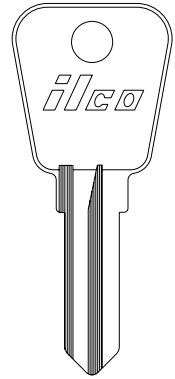
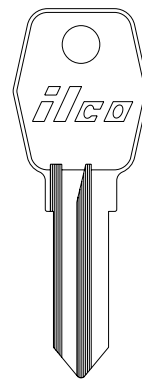
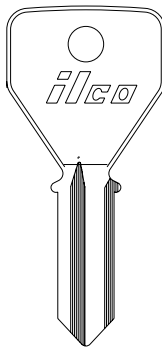
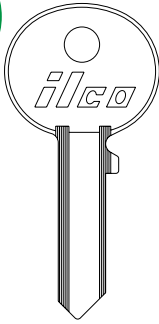

62DJ

-

62DS

-



62DX

-



62FS

-



62FE

-



62FG

-



62FT
F68YT

ILCO
EZ

VEHICLE KEYS

BRITISH LEYLAND

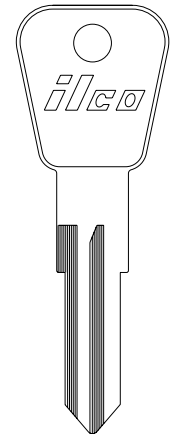
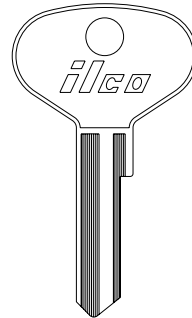
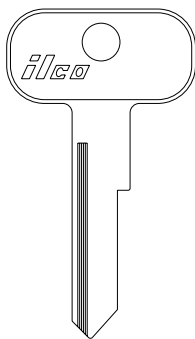
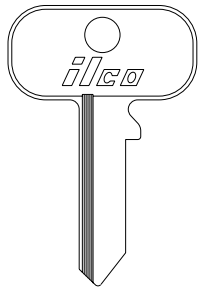

B62DP

-



B62DR

-



H62DP



H62DR

-



BR81R

-



HR62DG

-



L62FD

-

ILCO
EZ

BRITISH LEYLAND

B. S. A.

BUELL

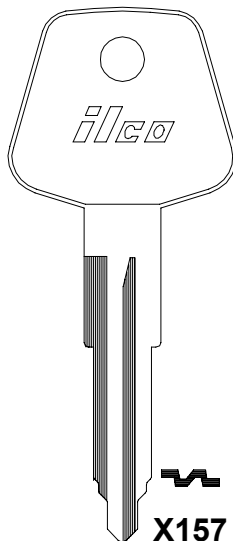
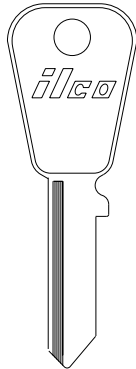
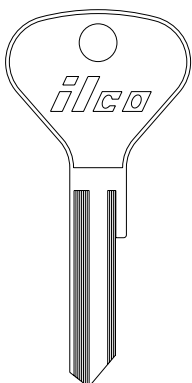

LR62DG

-



S62DP

-



S62DR

-



X157
LF17



R62DH

-



X270
TMC1

ILCO
EZ



BUELL

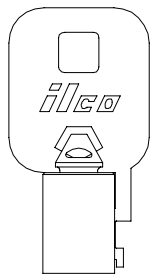

OD .377" - 0.6mm
ID .312" - 7.9MM
(BRASS)

ILCO
EZ

1137B
-

BUICK

**SEE
GENERAL
MOTORS
(GM)**

CADILLAC

**SEE
GENERAL
MOTORS
(GM)**

CAGIVA

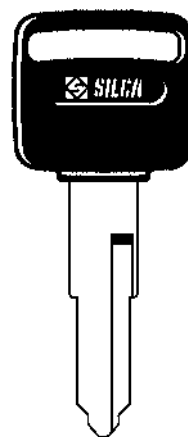

ZD21P-SI
-

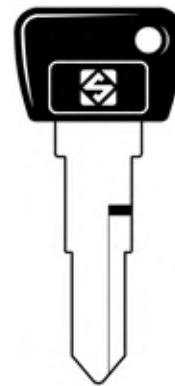

CG1P-SI
-

CAGIVA

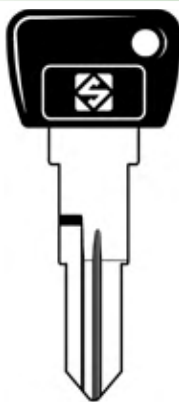

ILCO
EZ

CG2RP-SI
-

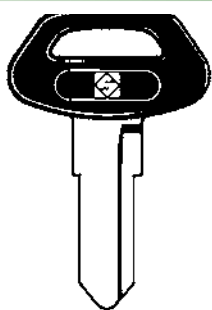

SZ4AP-SI
-



X259
-

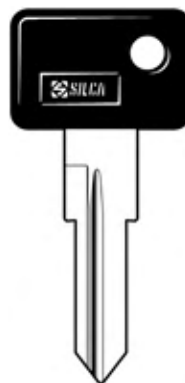

ZD16RP-SI
-



**X270
TMC1**

CAGIVA



ILCO
EZ

HD57
-

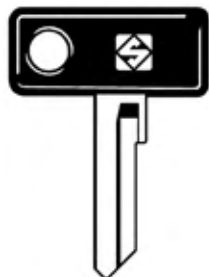

ZD9P-SI
-

CAN-AM

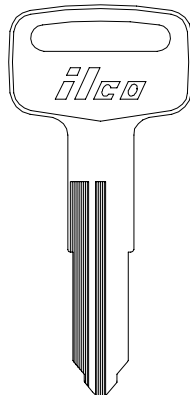

**X117
YH48**

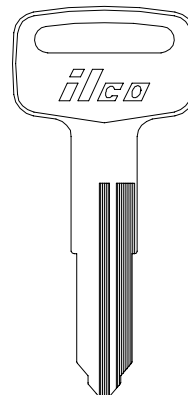

**X118
YH49**

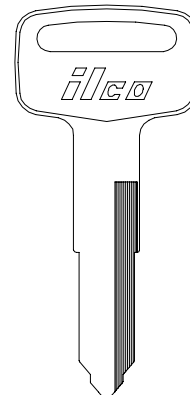

**X119
YH47**



CAN-AM

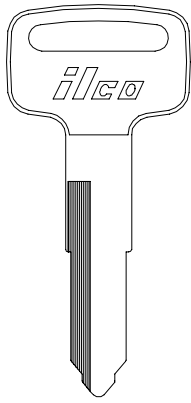

X120
YH46

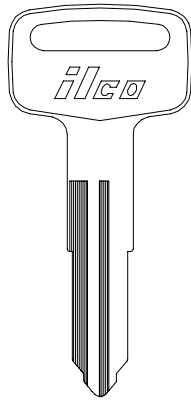

YH50
-

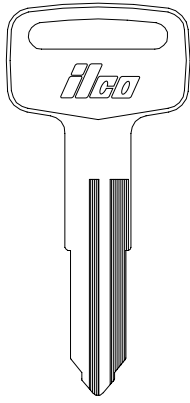

YH51
-



X111
YM55



X112
YM56

ILCO
EZ



VEHICLE KEYS

CATERPILLAR

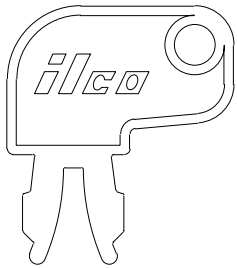

CNA2
-



1560
-



1583
-



1641
-

CESSNA



C1054B
-

ILCO
EZ



CESSNA

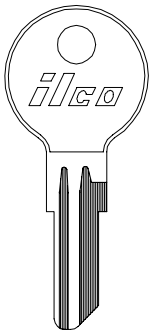

O1122
Y11



O1122A
Y12

1664
-

CHEVROLET

SEE
GENERAL
MOTORS
(GM)

CHICAGO



1041T
CG16

CHRYSLER

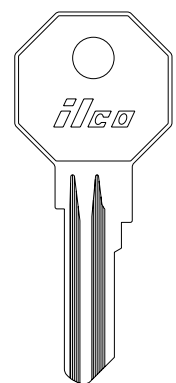

H199A
-

ILCO
EZ



CHRYSLER

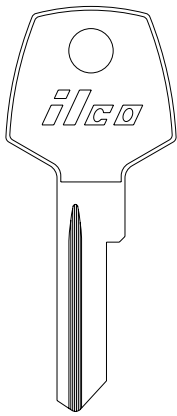

ILCO
EZ 704K
-

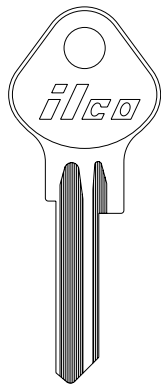

1199C
-

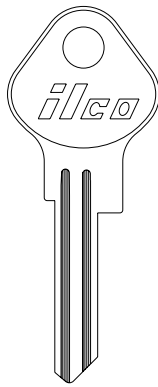

1199D
-

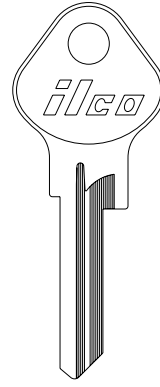

1199DR
-

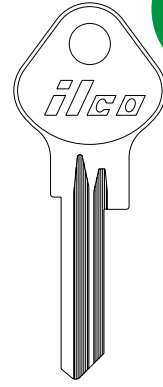

1199E
-

CHRYSLER

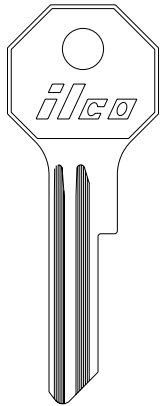

ILCO
EZ X1199A
-

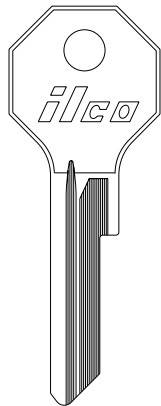

X1199AR
Y133



X1199B
-



X1199G
-



X1199J
-

CHRYSLER

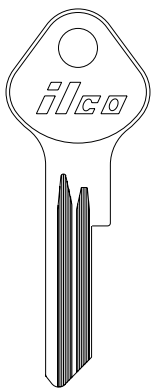

ILCO
EZ XO1199B
-

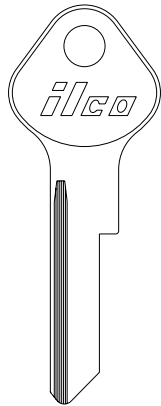

XO1199G
-

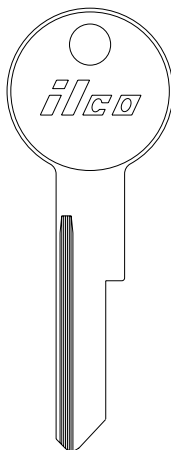

1701G
-

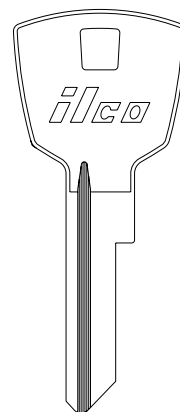

1702K
-

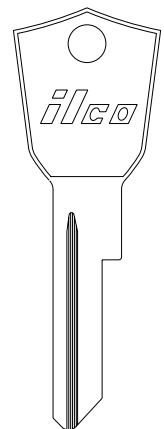

1703K
-



CHRYSLER

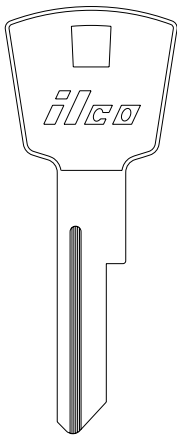

1704K
-

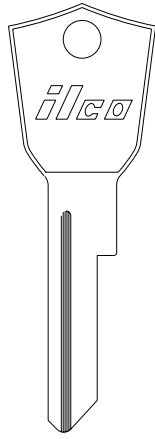

1705K
-

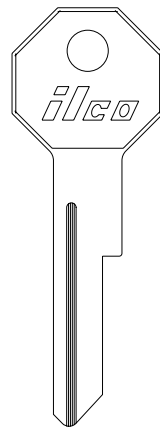

1706K
-

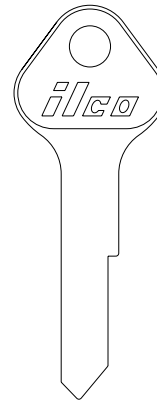

1759P
-

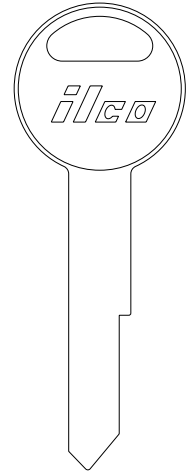

D1759L **ILCO**
- **EZ**

VEHICLE KEYS

CHRYSLER



1764P
-

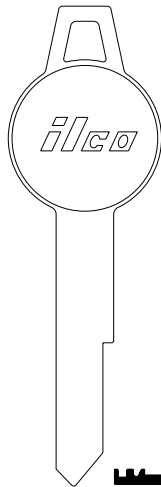

1764S
-

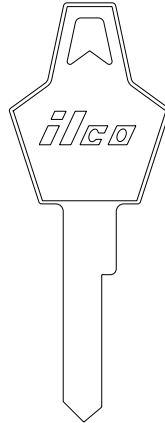

1766DT
-



1766S
-

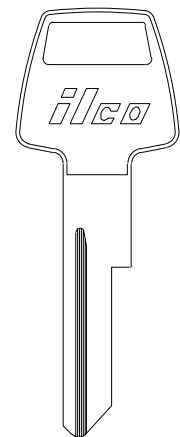

1767CH **ILCO**
Y146 **EZ**

CHRYSLER

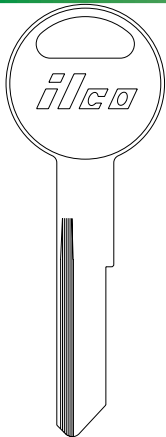

S1767CH
Y138



1767DT
-



1768CH
-

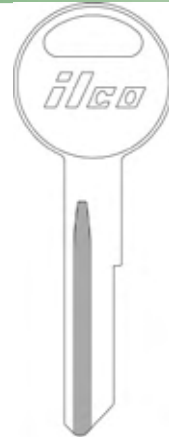

S1768CH
-

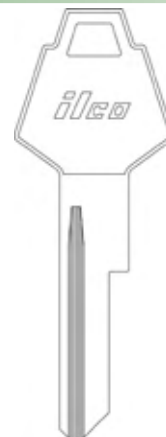

1769CH
-

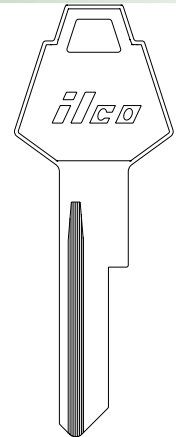

1770CH **ILCO**
- **EZ**

CHRYSLER

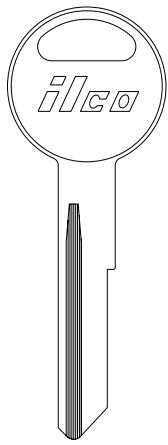

ILCO
EZ U1770CH
-

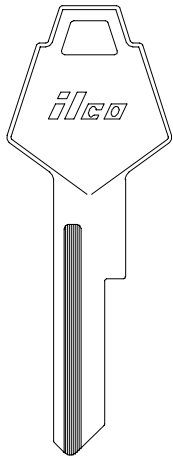

P1770U
Y152

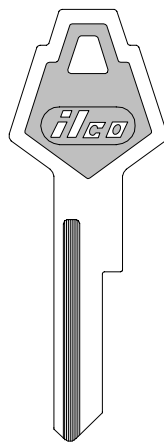

Y152-PC
-

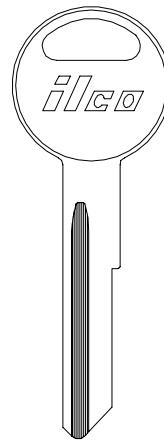

S1770U
Y149

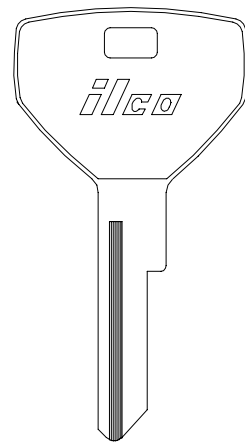

P1786
Y153

CHRYSLER

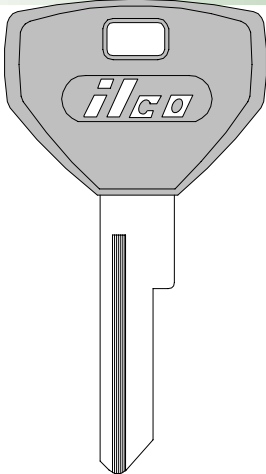

ILCO
EZ Y153-P
-

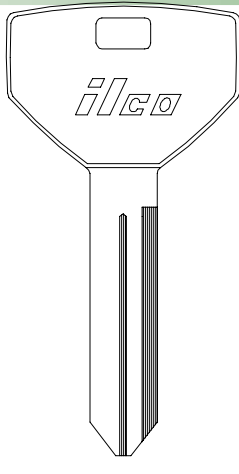

P1789
Y154

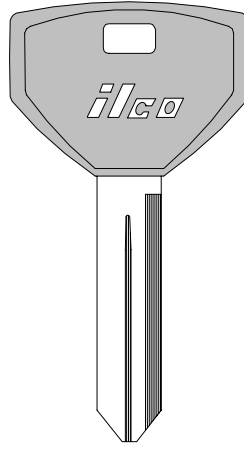

Y154-P (-PC)
-

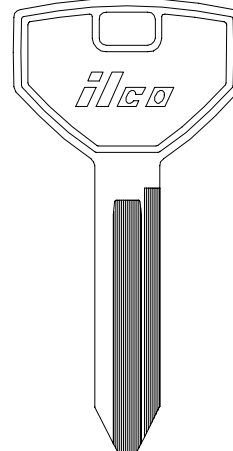

P1793
Y155

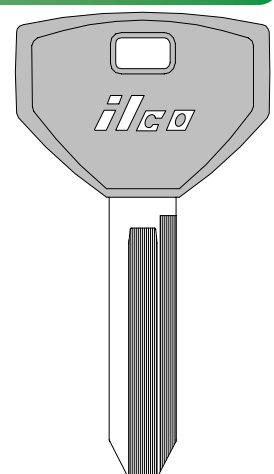

Y155-P (-PC)
-

CHRYSLER

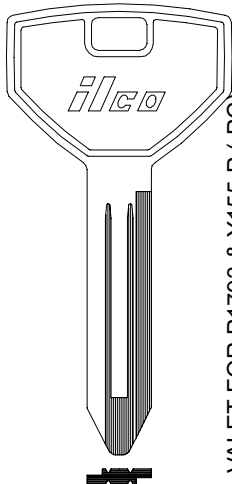

ILCO
EZ 1793V
-

VALET FOR P1793 & Y155-P (-PC)

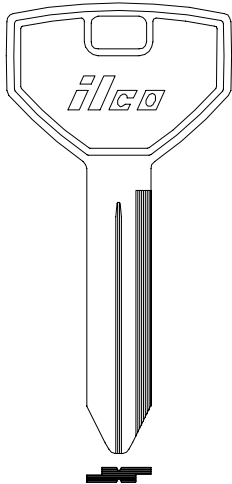

P1794
Y157

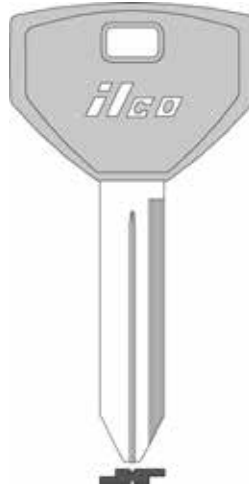

Y157-P (-PC)
-

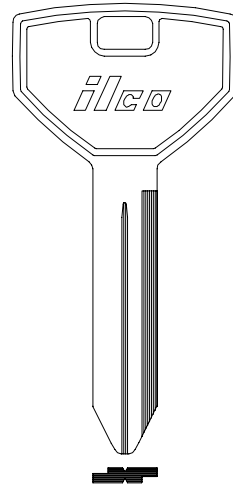

1794V
-

VALET FOR P1794 & Y157-P (-PC)

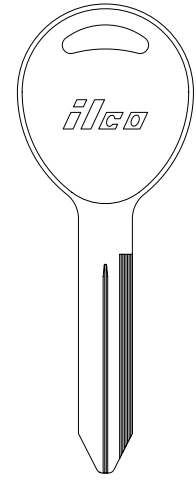

P1795
Y159

VEHICLE KEYS





CHRYSLER

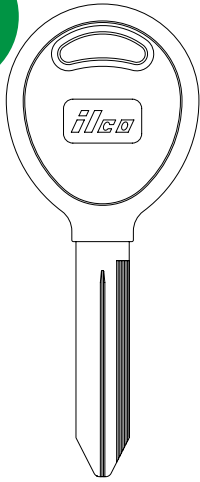

Y159-P

-

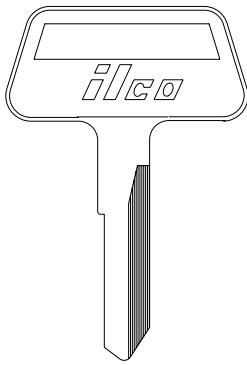

MS2

-

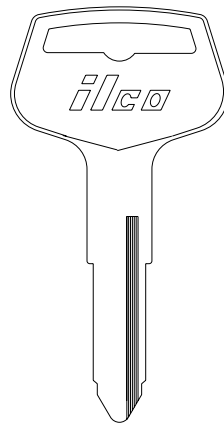

MS13

-

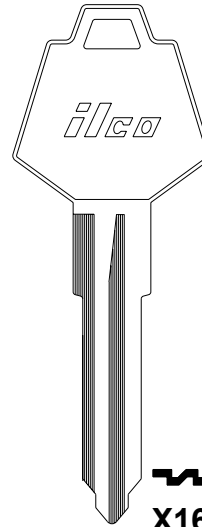

**X16
P1771CR**

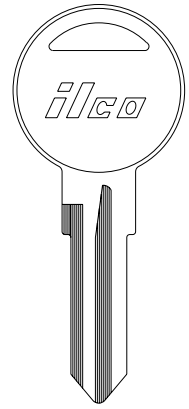

**X17
S1771CR**

**ILCO
EZ**

VEHICLE KEYS

CHRYSLER

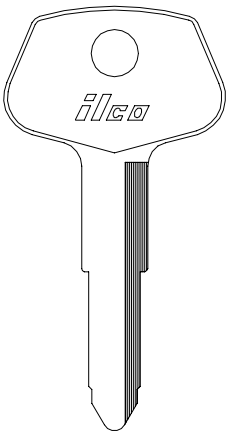

**X54
DC1**



DC1-P

-

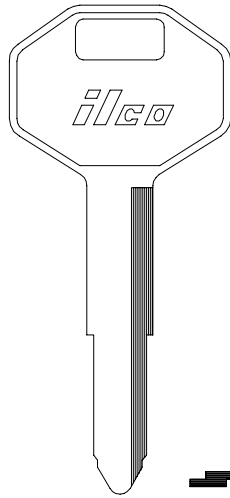

**X121
DC3**

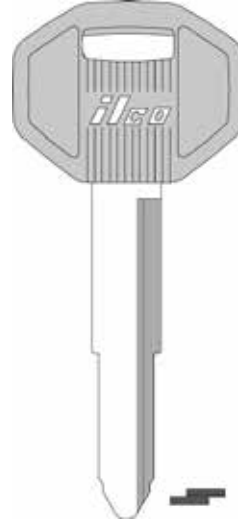

DC3-P (-PC)

-

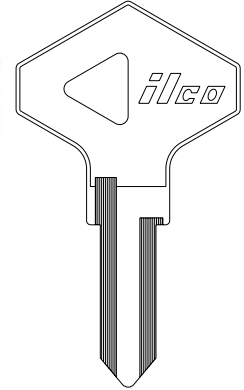

**X122
RN29**

**ILCO
EZ**

CHRYSLER



**GTH
(Head Only)**

**EB3-Z-HU64
(Blade Only)**



**HU64-GTK
(Complete Key)**

SEC 1
PG 60



SIP22MH

-

**ILCO
EZ**



CHRYSLER



ILCO
EZ



SIP22-GTS
-

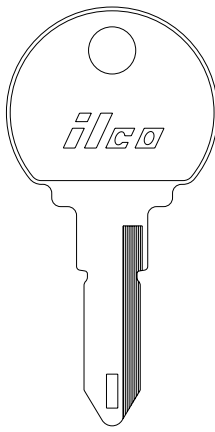

X147
RN30

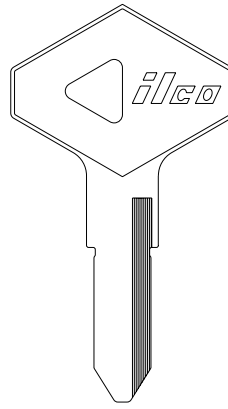

X171
RN31

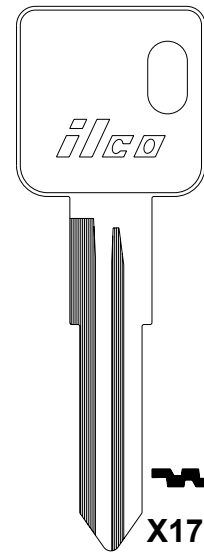

X175
RN32

CHRYSLER

ILCO
EZ

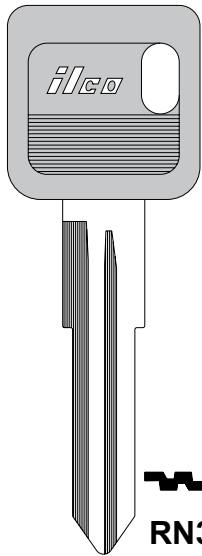

RN32-P
-

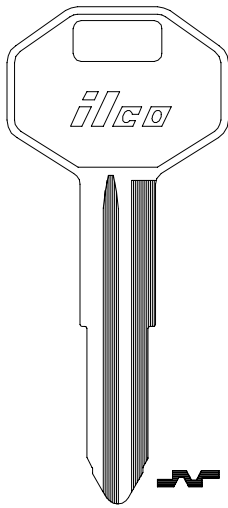

X176
MIT1

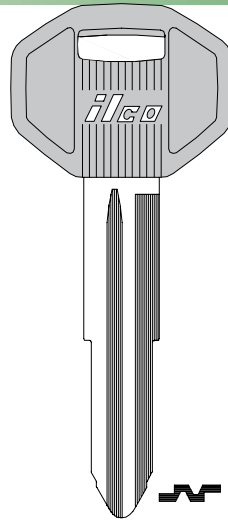

MIT1-P (-PC)
-

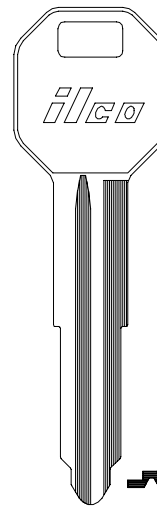

X213
MIT2

VALET FOR X176 & MMIT1-P (-PC)

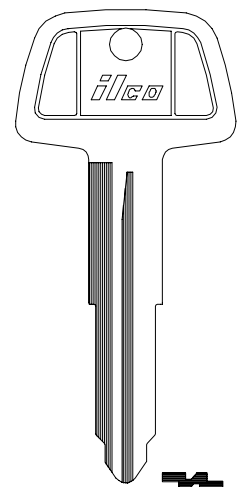

X224
MIT3

CHRYSLER

ILCO
EZ

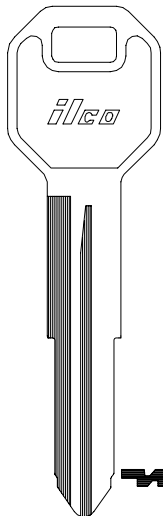

X229
MIT5

VALET FOR X224

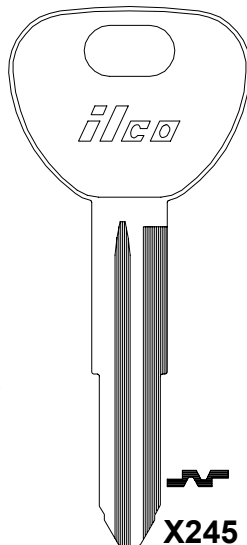

X245
MIT4

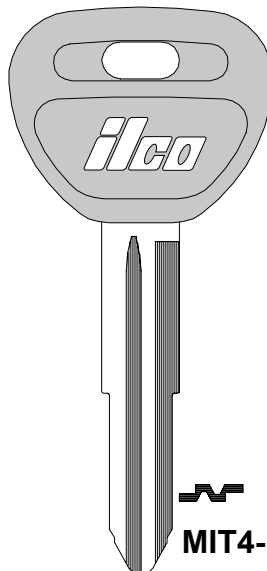

MIT4-P
-

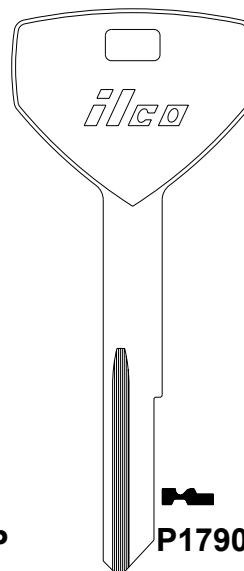

P1790TC
-



Y160-PT
-

VEHICLE KEYS





CHRYSLER

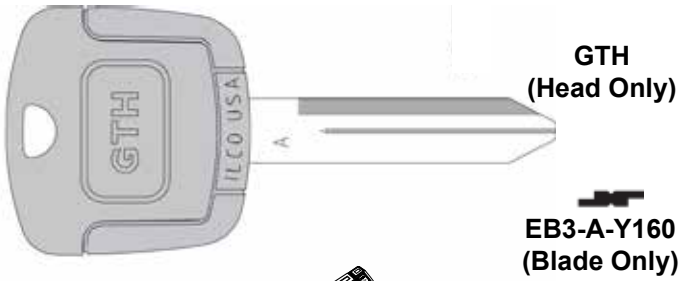

**GTH
(Head Only)**

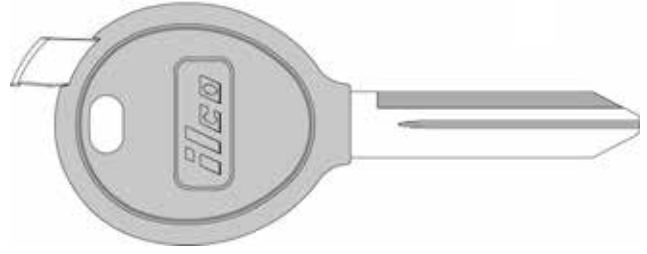

**EB3-A-Y160
(Blade Only)**



**Y160-GTK
(Complete Key)**



**Y160GTS
-**

**ILCO
EZ**

VEHICLE KEYS

CHRYSLER



**Y160FB
Y164FB**

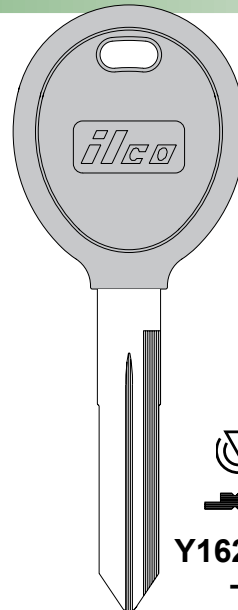

**Y162-PT
-**

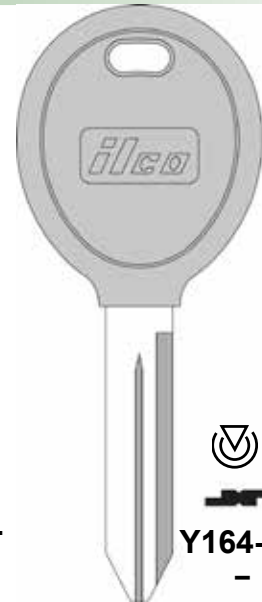

**Y164-PT
-**

**ILCO
EZ**

CHRYSLER

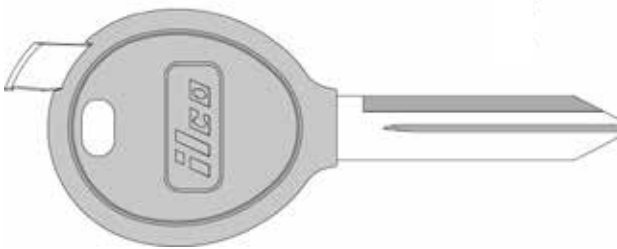

**Y164GTS
FT46**

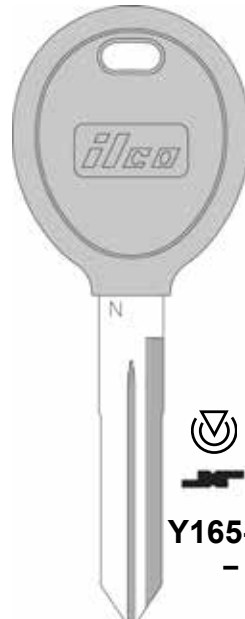

**Y165-PT
-**

**ILCO
EZ**



CHRYSLER

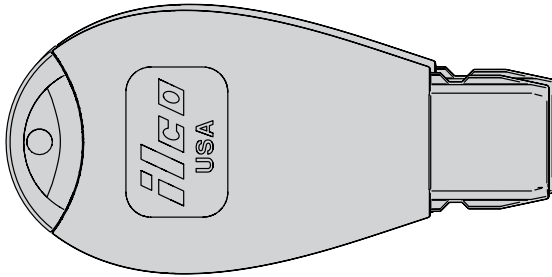

Y170-MHK

ILCO
EZ

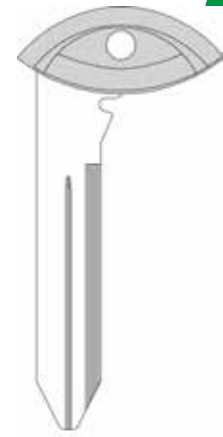

Y171-P

CHRYSLER

CHRYSLER OUTBOARDS



ILCO
EZ

Y172

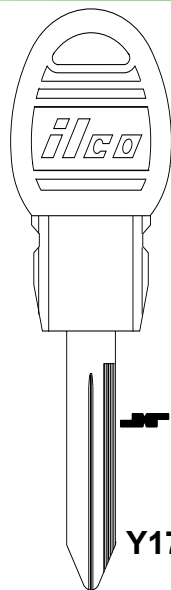

Y173-PT

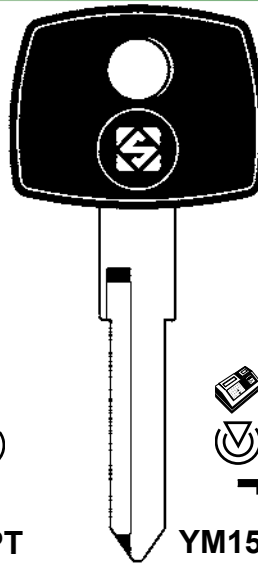

YM15T5-SI



CH3

CH4

CH5

CH6

CH7

VEHICLE KEYS

CH8

CITROEN

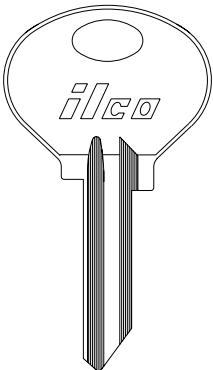

SM1



SM2

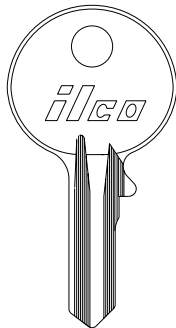

7DC



R7DC

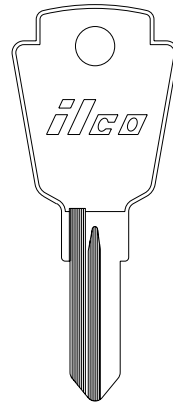

SMS8

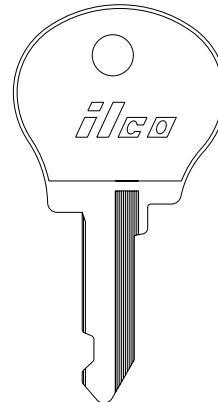

NE18

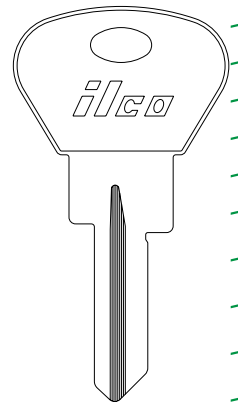

VC24

ILCO
EZ





CHRYSLER

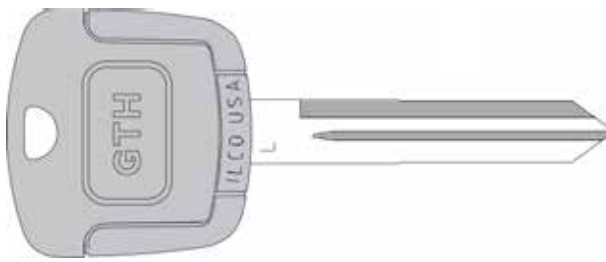

GTH
(Head Only)



EB3-L-MIT9
(Blade Only)



MIT9-GTK
(Complete Key)

ILCO
EZ

VEHICLE KEYS

CHRYSLER

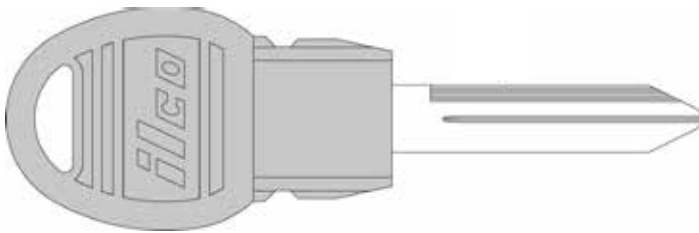

Y170-PT
-

ILCO
EZ

CHRYSLER

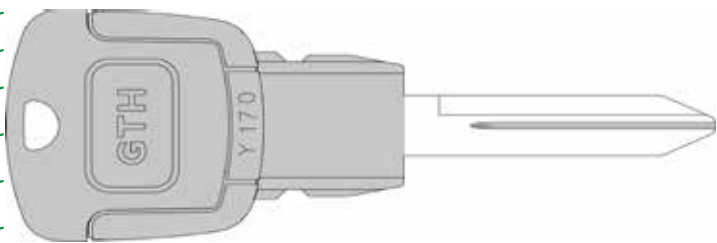

GTH
(Head Only)



EB3-T-Y170
(Blade Only)



Y170-GTK
(Complete Key)

ILCO
EZ

CITROEN

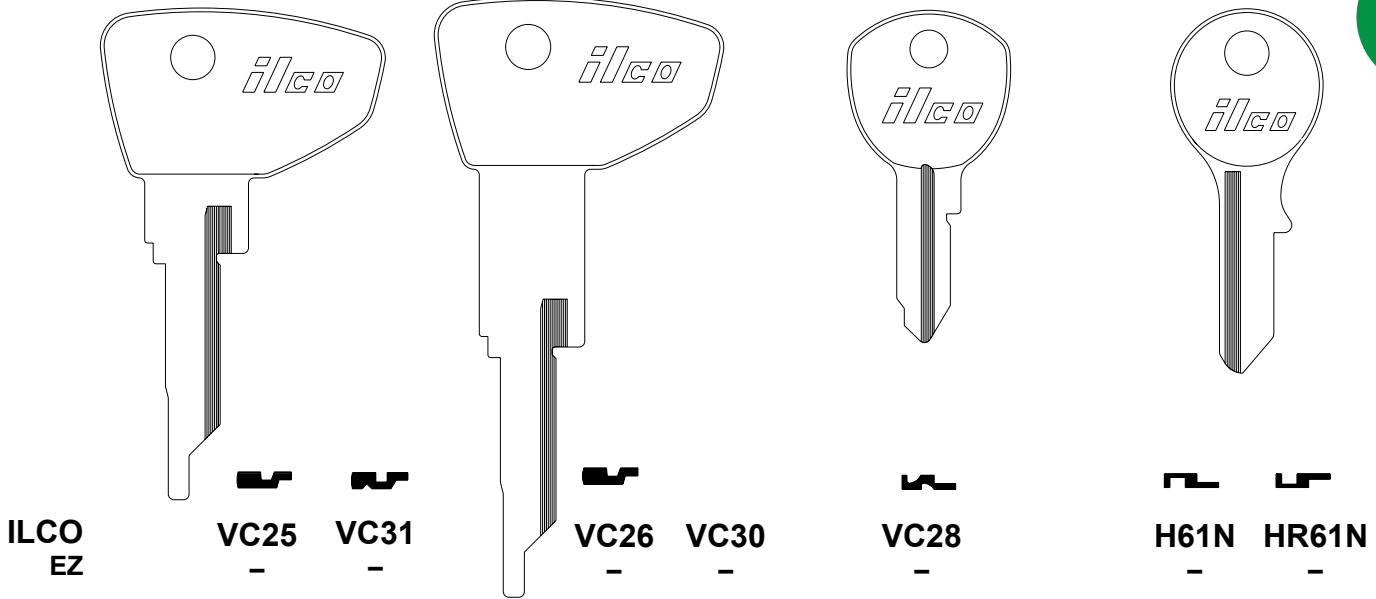

CITROEN

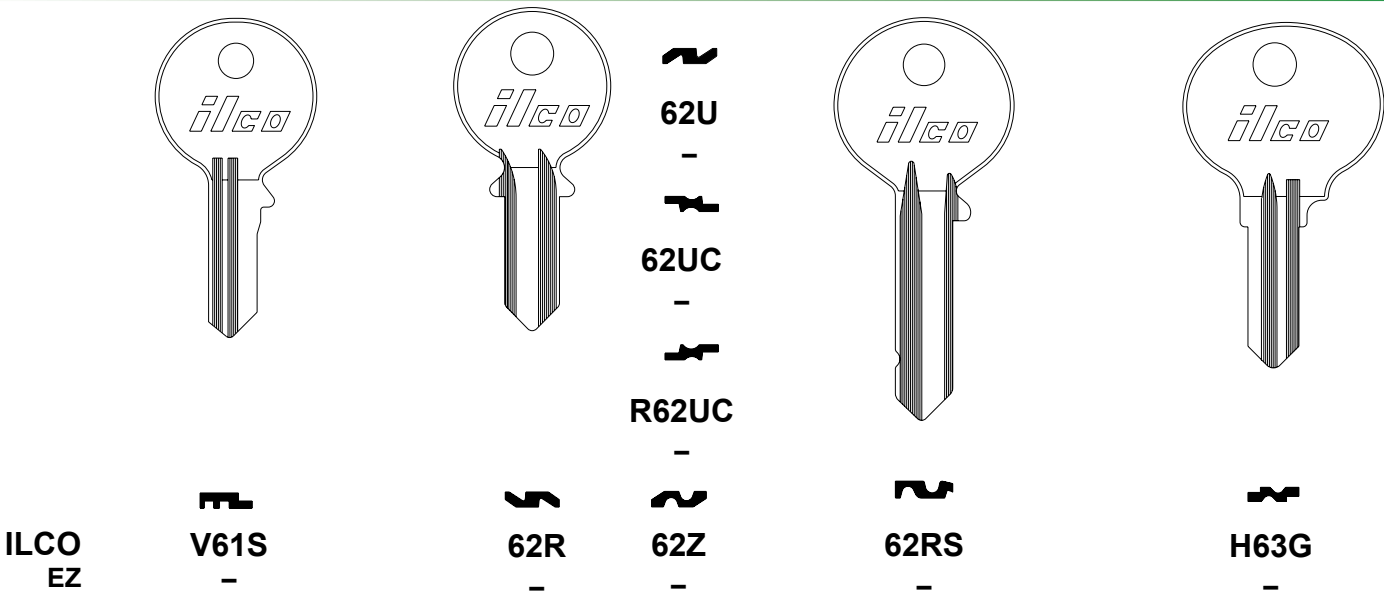

CITROEN

THE CLUB

CLUM INBOARD MOTORS

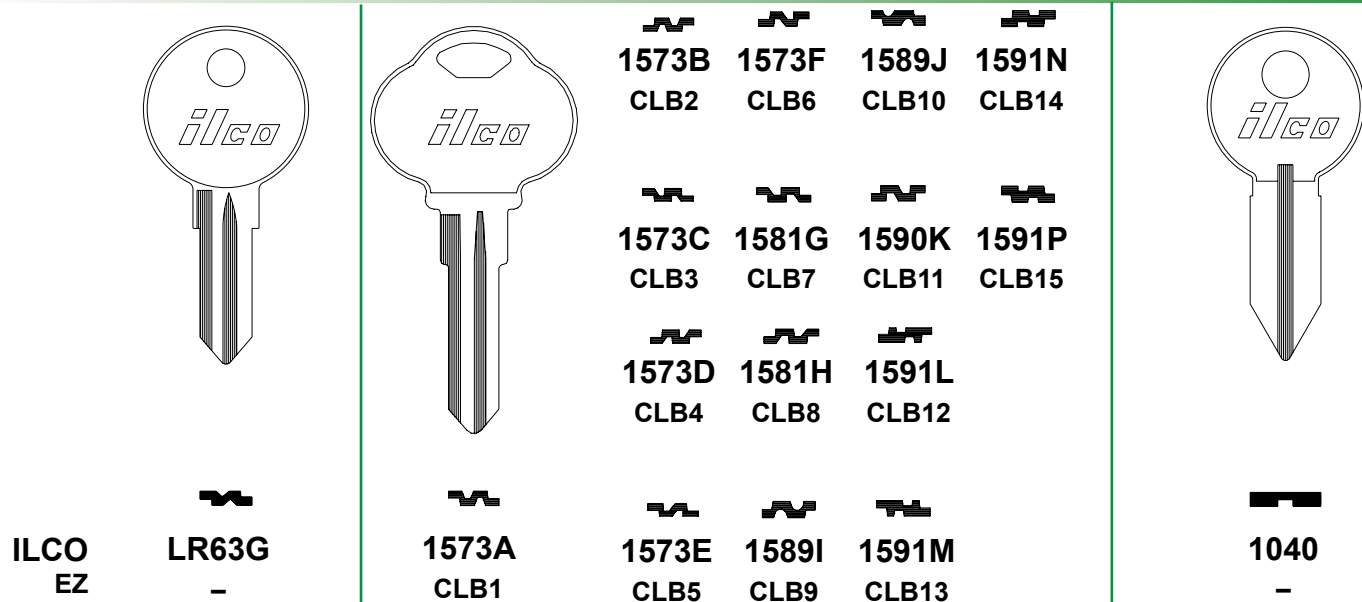



CLUM INBOARD MOTORS

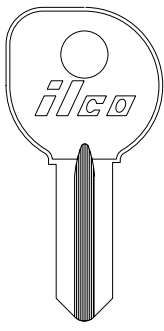

1040A
-

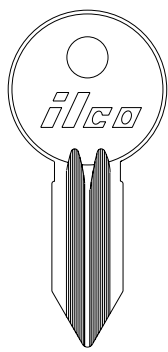

1040B
-

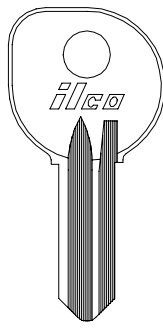

1040C
-

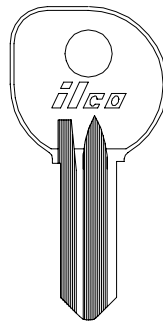

R1040C
-

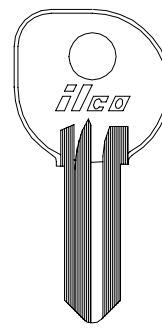

1040E
-

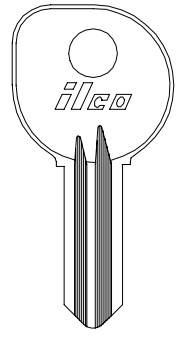

R1040E
ILCO
EZ

VEHICLE KEYS

COSMOPOLITAN

D. A. F.

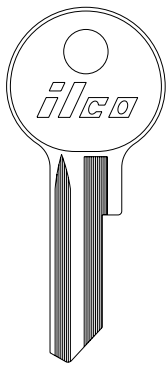

GE7
-

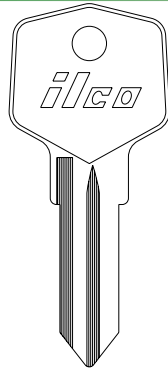

CA2
-

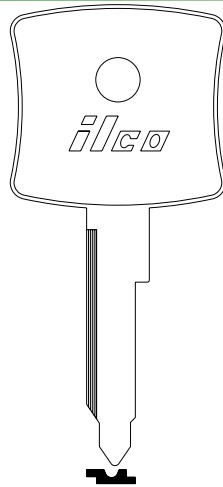

HF41
-

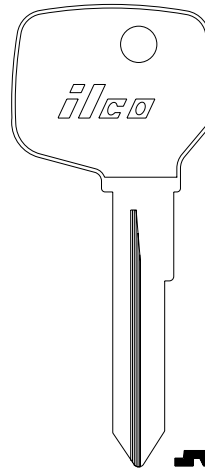

HF43
-

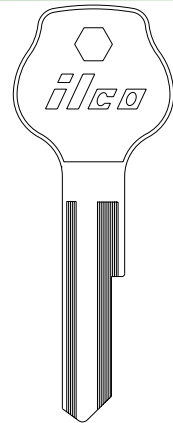

L62VA
-

LR62VA
-

ILCO
EZ

D. A. F.

D. K. W.

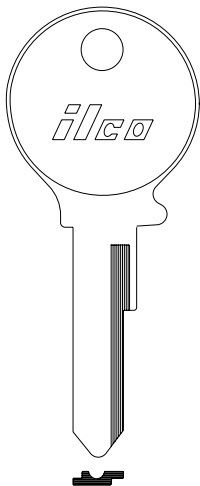

VW64T
-

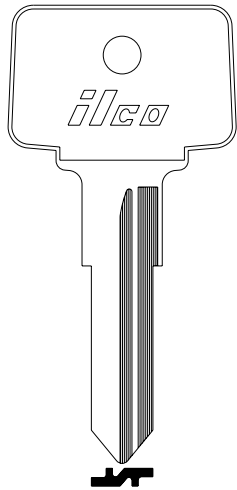

X81
HF46

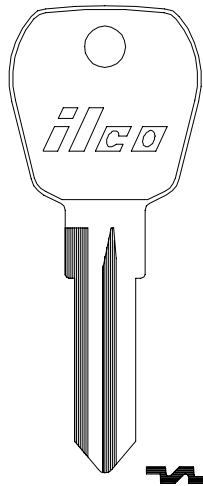

X86
FC7

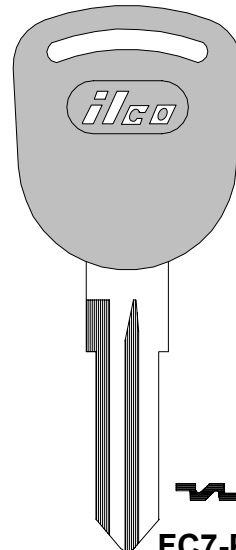

FC7-P
-

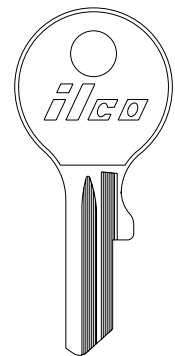

BU1
-

BU2
-

ILCO
EZ

D. K. W

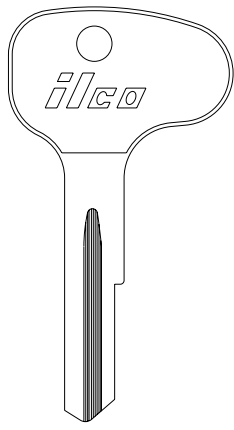

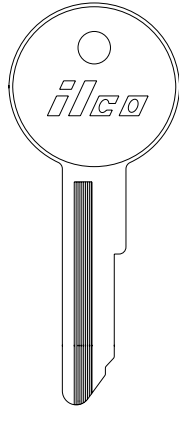

PR1
-



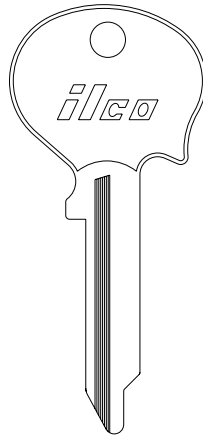

WT1
-

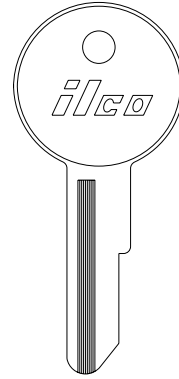

NE2
-



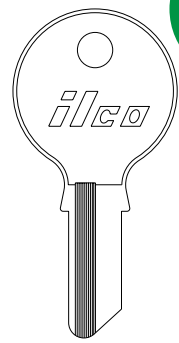

WT2
-



DK3
-

ILCO
EZ

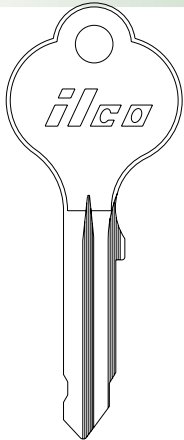
D. K. W



YM3
-

ILCO
EZ

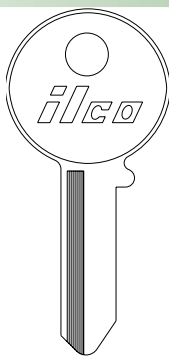



61N
-

61NA
-

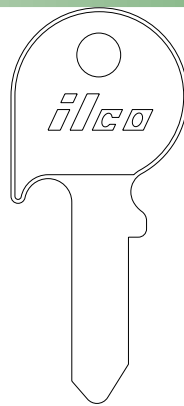
R61NA
-



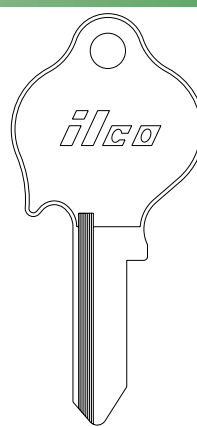

H61NA
-





HR61NA
-

H61NA HR61NA

H61VM
-

H61VO
-

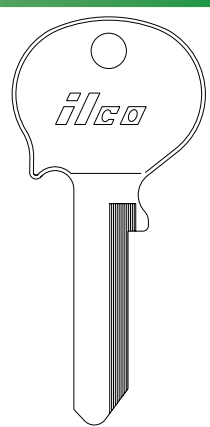
H61VM H61VO



H61VR
-

H61VR

D. K. W

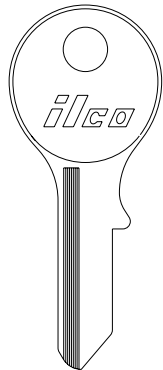

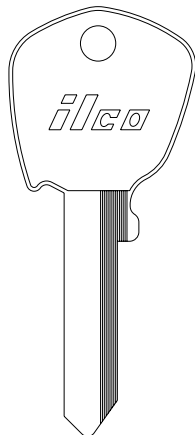

H61N
-

ILCO
EZ



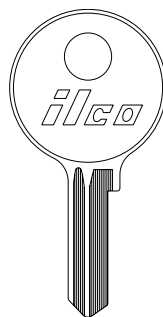

T61VR
-

T61VR



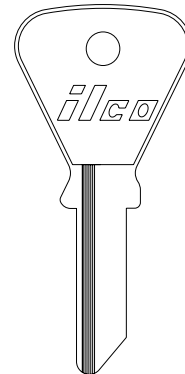

62VG
-

62VG

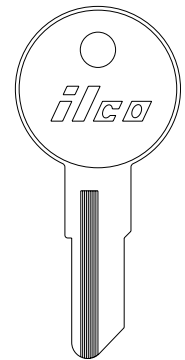

62VH
-

62VH



62VM
-

62VM

VEHICLE KEYS





D. K. W.

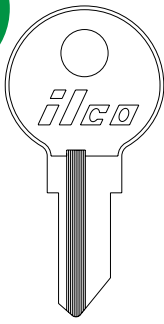

62VO
-

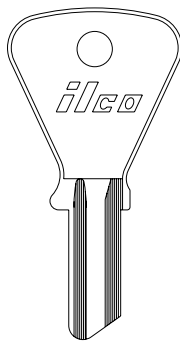

B62G
-

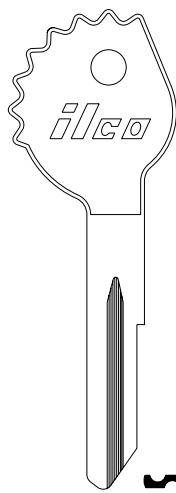

L62VN
-

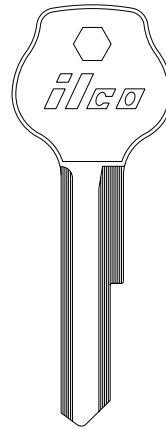

R62WA
-

62WA
-

62WB
-

A62VN
-

H62VK
-

HR62VK
-

L62VA
-

L62VB
-

LR62VB
-

R62PE
-

ILCO
EZ

D. K. W.

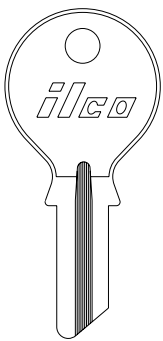

63
-

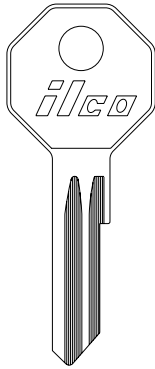

63A
-

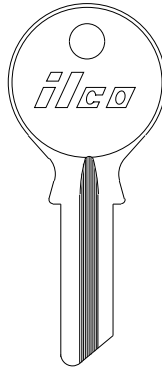

63L
-

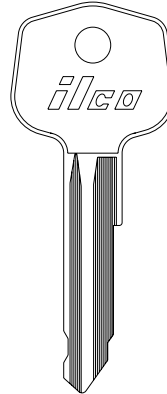

R63E
-

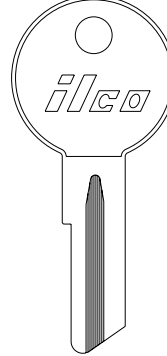

XD63
-

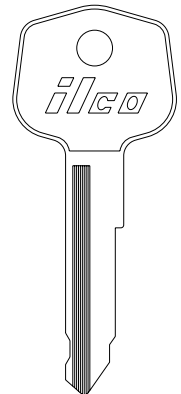

65M
-

ILCO
EZ

D. K. W.

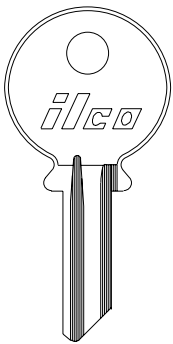

F65
-

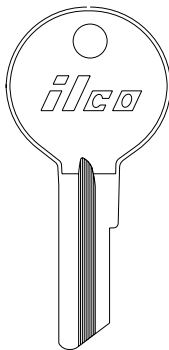

DK91D
-



DK91G
-

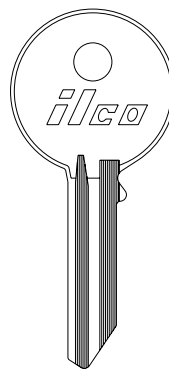

DK91U
-

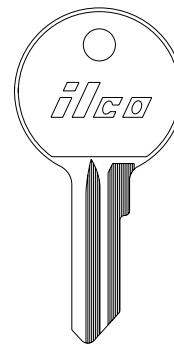

DK91H
-

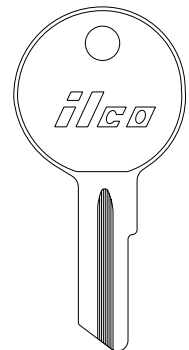

DK91K
-

DK91L
-

ILCO
EZ

VEHICLE KEYS

DAEWOO

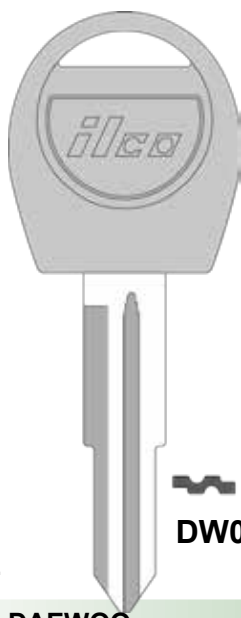

ILCO
EZ

DW04RAP DW04RT6

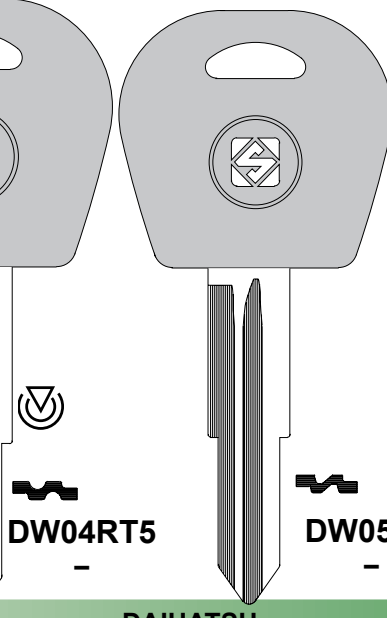

DW04RT5

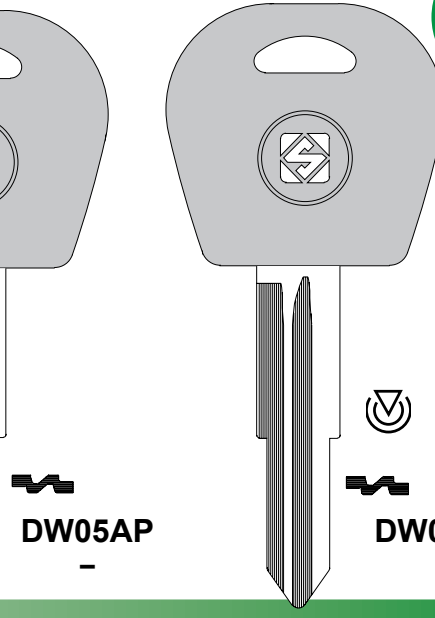

DW05AP

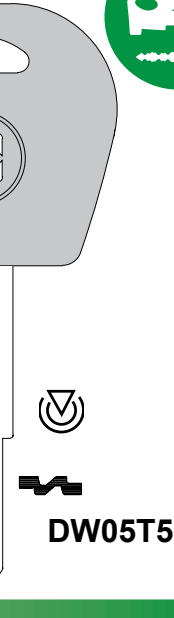

DW05T5

DAEWOO

DAIHATSU

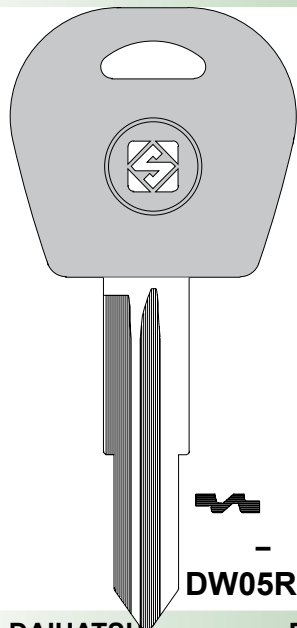

ILCO
EZ

DW05RAP

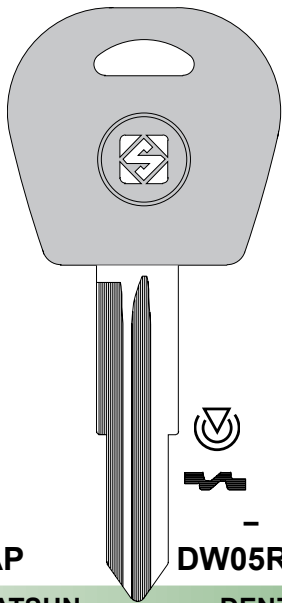

DW05RT5

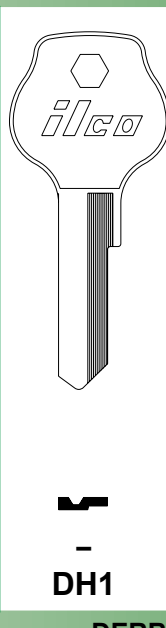

DH1

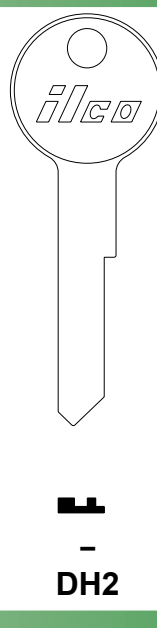

DH2

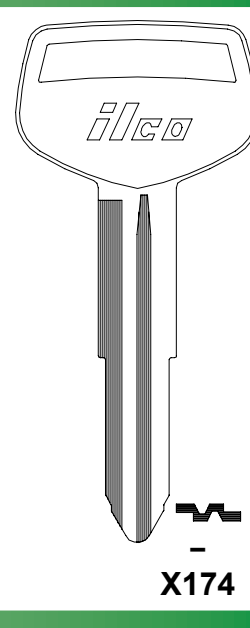

X174

DAIHATSU

DATSUN

DENZAL

DERBI

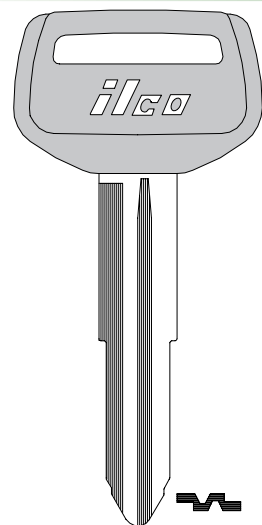

ILCO
EZ

TR40

SEE
NISSAN

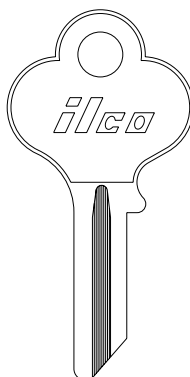

TR40-P



ZD24RDP-SI



GT15RDT5-SI



VEHICLE KEYS



VEHICLE KEYS

DERBI

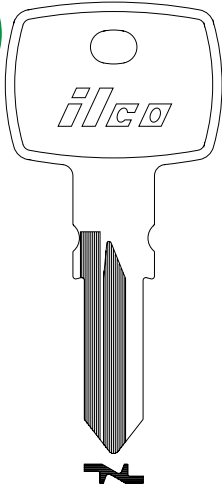

X270
TMC1

DIAMOND REO

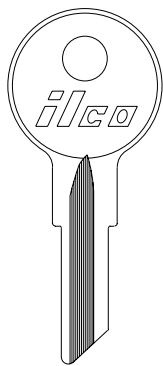

1098M
B1

DODGE

SEE
CHRYSLER

DUCATI

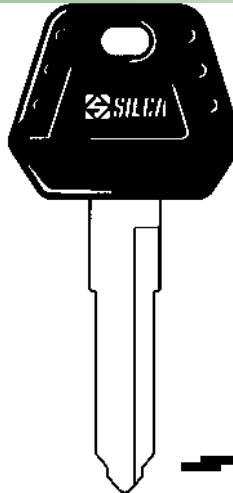

KW14P
-

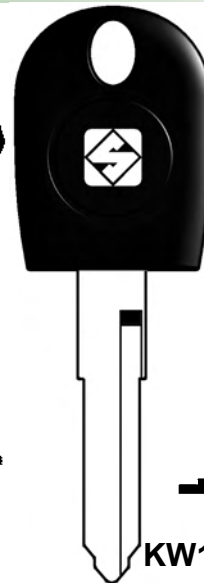

KW17T5
- ILCO
EZ

DUCATI

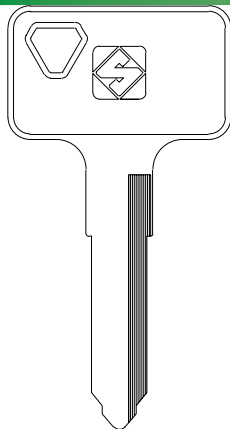

X259
KW14

EAGLE

SEE
CHRYSLER

ESCURRA

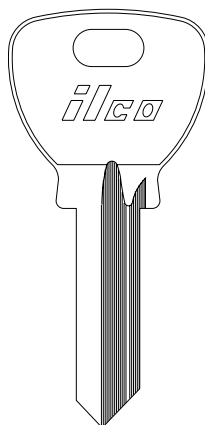

ES1 ES1R
- -

EVINRUDE MOTORS

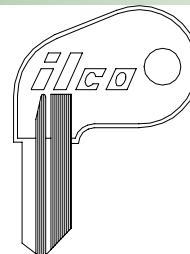

OM10
-

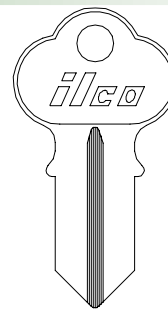

1041G
CG1 ILCO
EZ

EVINRUDE MTRS

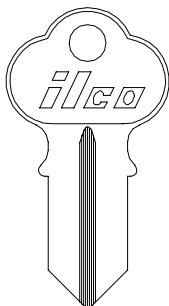

1041GA
CG2

FERRARI

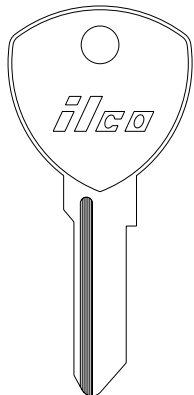

GT2 GT3
- -

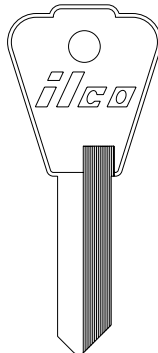

LN4
-

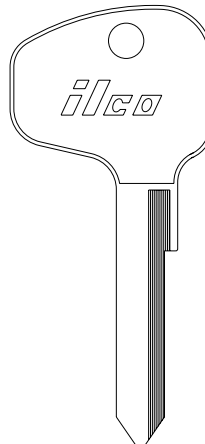

NE8
-

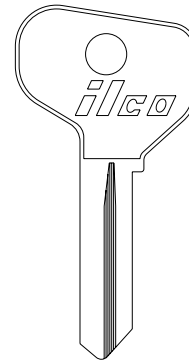

FT37 FT38
- - ILCO
EZ

SEC 1

PG 70





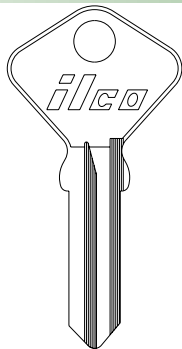
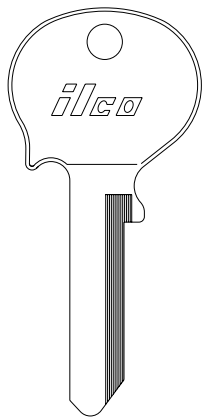

FERRARI

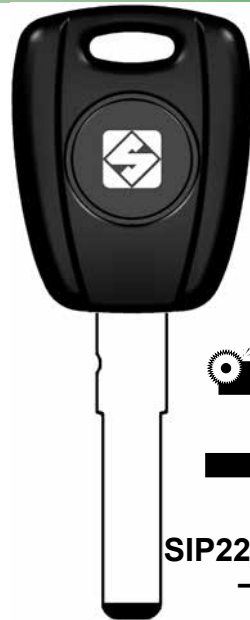

 F91CR
-
 F91C2
-
 F91C8
-



  SIP22-GTS
-



   SIP22MH
-

ILCO H61VR
EZ -

F91C
-

SIP22-GTS
-

SIP22MH
-

FERRARI

FIAT

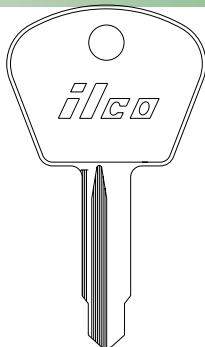
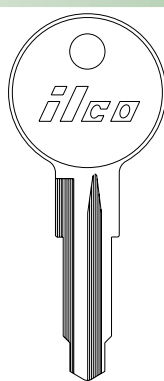
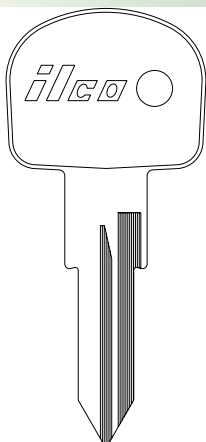

 SP3
-
 SP4
-

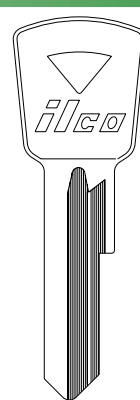
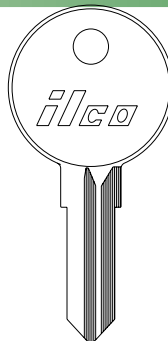

ILCO X152
EZ FT46

FS1
-

SP1
-

SP2
-

TR1
-

WS1
-





WS3
-

WS2
-

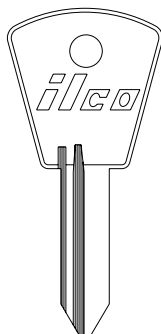
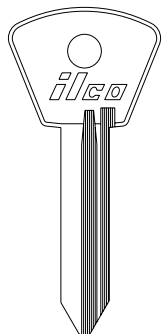
WS4
-

FIAT



 F38
-
 F39
-
 F40
-
 F41
-

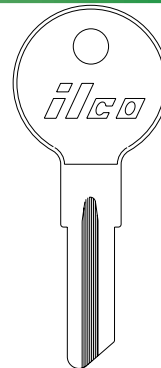
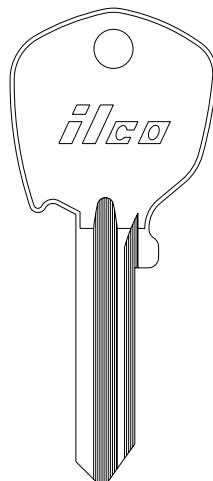
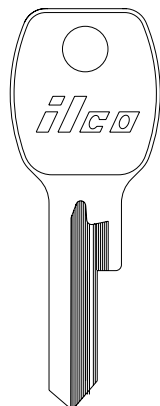
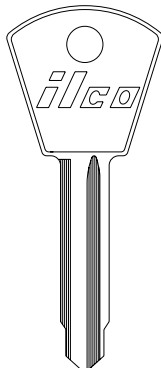

ILCO AL3
EZ -

AL4
-

SP5
-

WS5
-

FT6
-

FT6R
F81E

LA6
-





FIAT

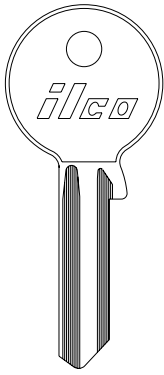

WS6
-

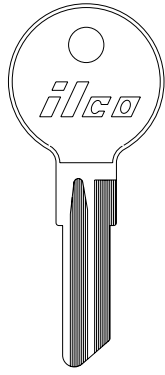

LA7
-

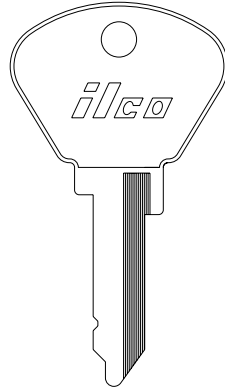

NE9
-

ILCO
EZ

VEHICLE KEYS

FIAT

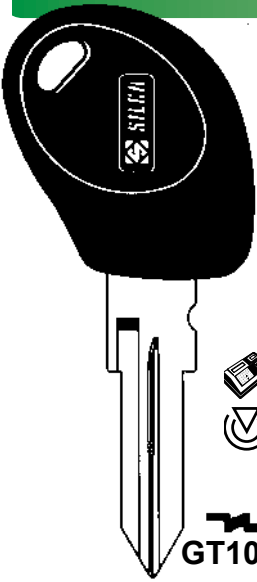

GT10BT2/5
-

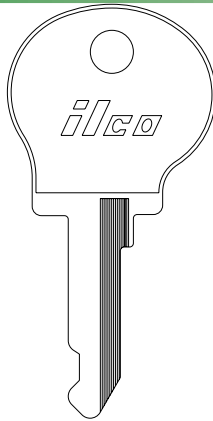

NE13
-

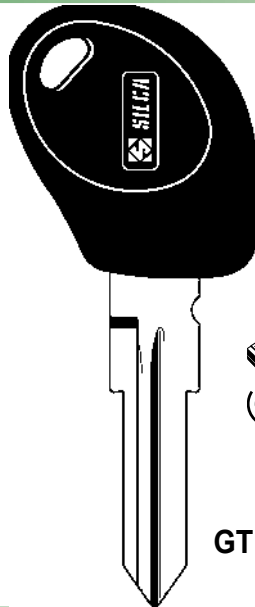

GT15RBT2/T5
-



F22
-

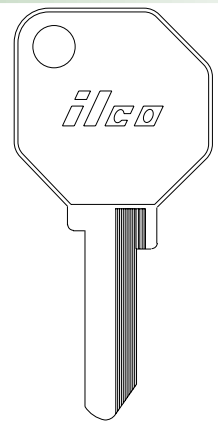

NE23
-

ILCO
EZ

FIAT

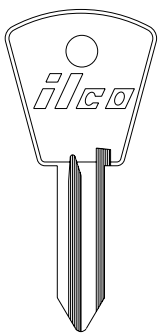

F33
-

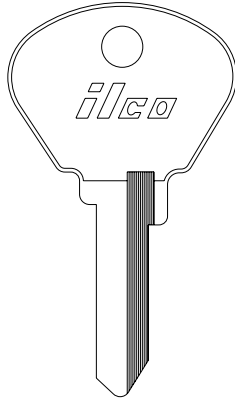

F44
-

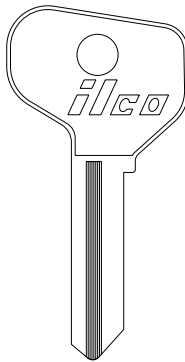

F54
-

FT37
-
FT38
-

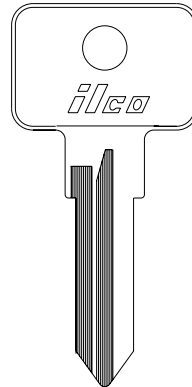

NE54
-

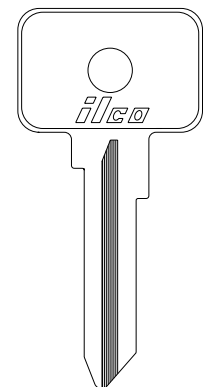

NE55
-

NE56
-

ILCO
EZ



FIAT

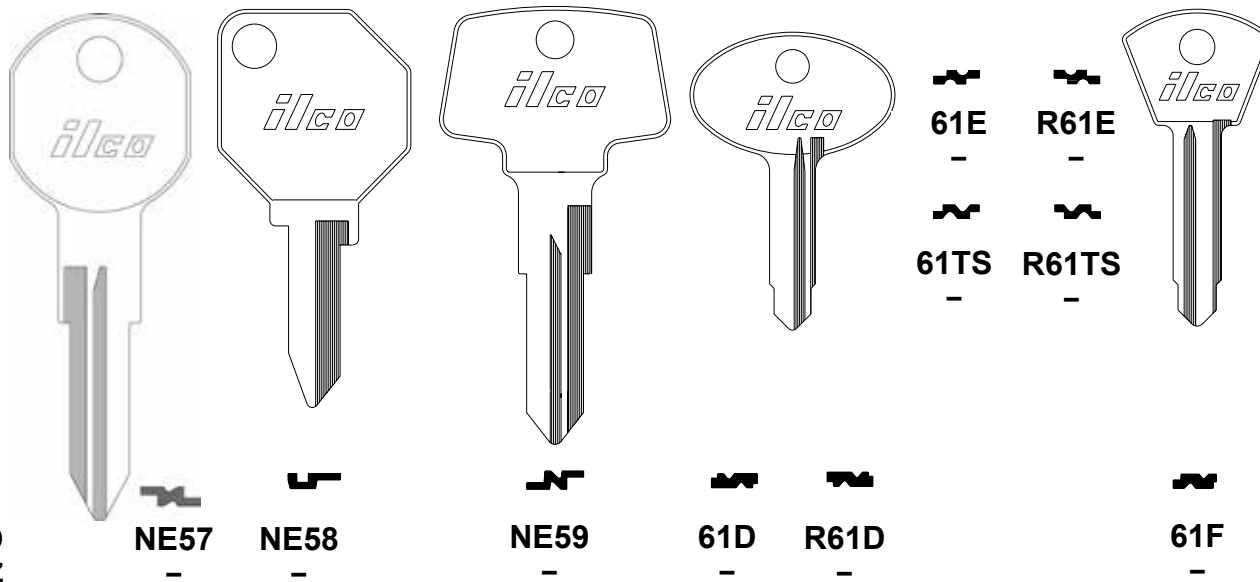

ILCO EZ NE57 NE58 NE59 61D R61D 61F

FIAT



ILCO EZ 61G R61G 61GA R61GA 61H R61H 61J H61G

FIAT

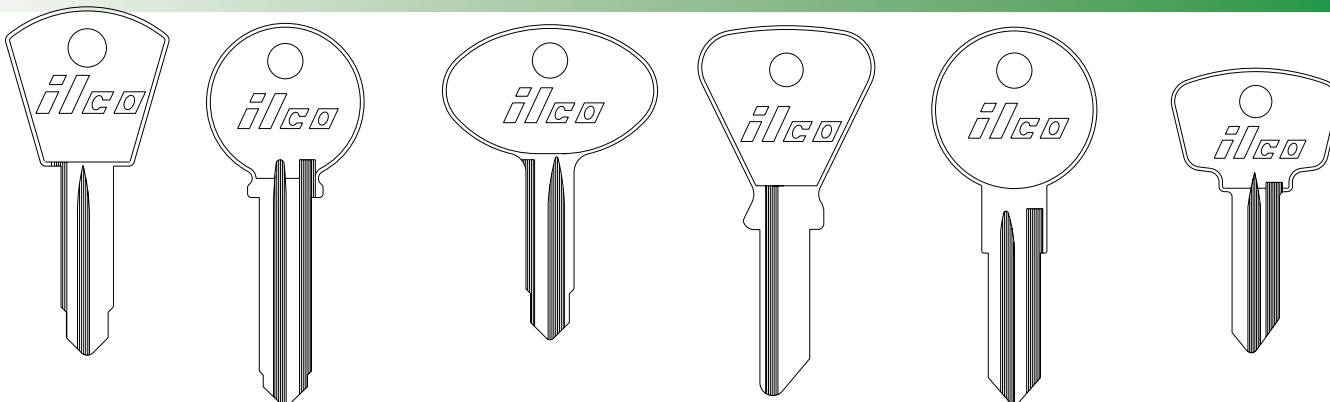

ILCO EZ DR61F L61G LR61G R62TS R61ST 62VH Y62 YR62 63SP R63SP



FIAT

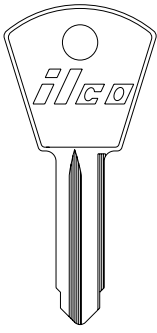

63ST
-

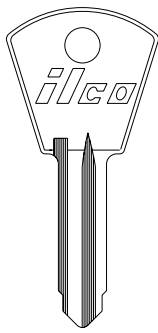

R63ST
-

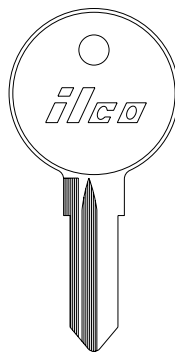

63TS
-

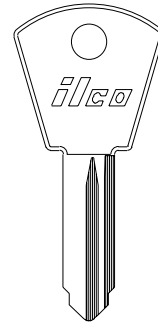

R63H
-

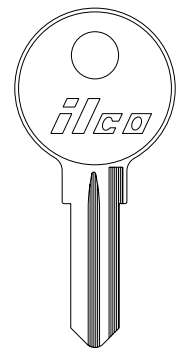

R63TS
-

64S
-

ILCO
EZ

VEHICLE KEYS

FIAT

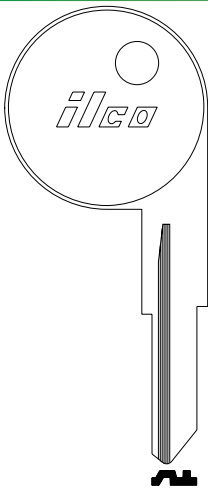

X78
SP8

X79
SP7

X64
SP6

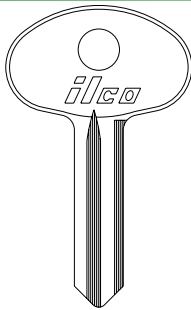

65G
-

R65G
-

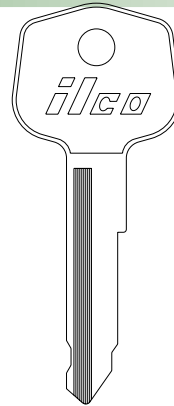

65FA
-

R65FA
-

65M
-

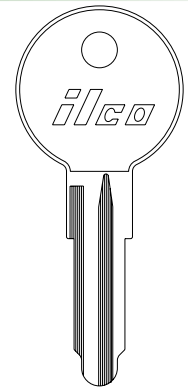

66A
-

ILCO
EZ

FIAT

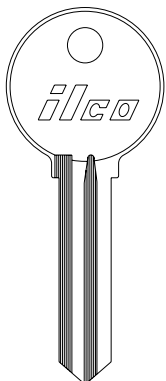

F91CR
-

F91C2
-

F91C8
-

66BB
-

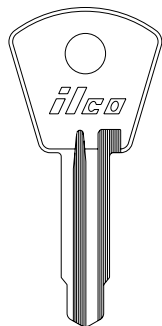

F66C
-

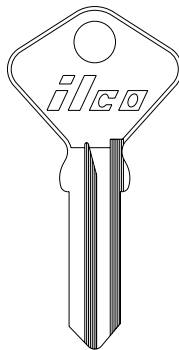

F91C
-

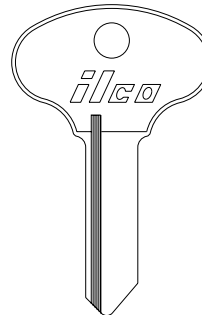

F91ES
-

F91FS
-

F91GS
-

F91HS
-

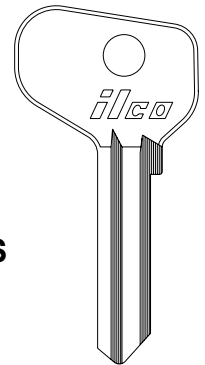

X99
-

ILCO
EZ

FIAT

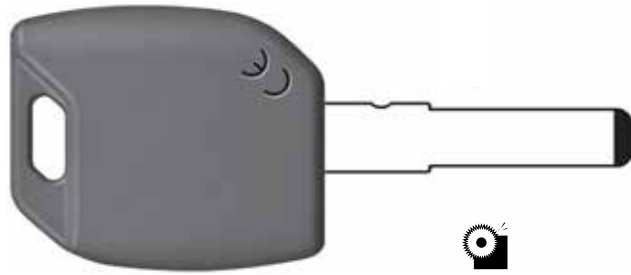
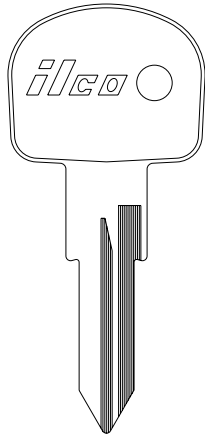
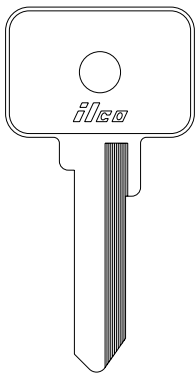

ILCO X109 X113
EZ FT43 -

X152
FT46

SIP22MH
-

FIAT

FORD

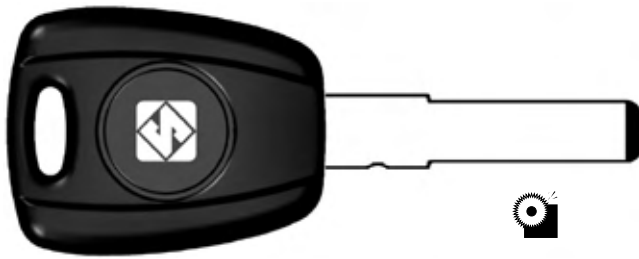

ILCO
EZ

SIP22GTS
-



SIP22FB
-

P1117
HU101

FORD

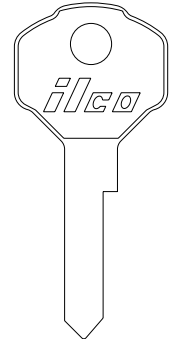
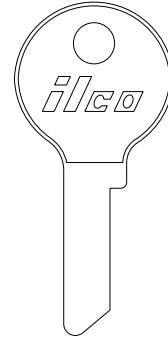
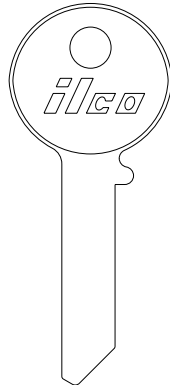
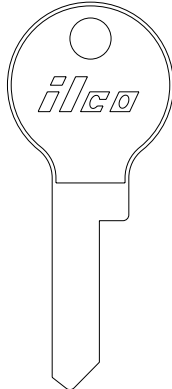
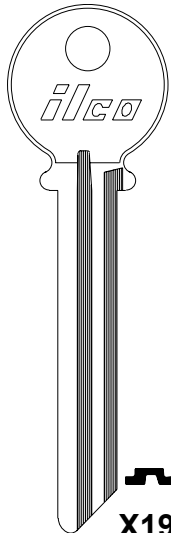

ILCO X194
EZ HD97

RV1
-

1125
H6

1125A
-

1125F
-





FORD

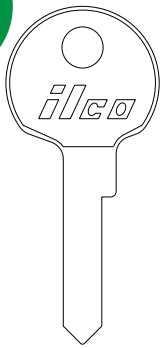

1125G

-

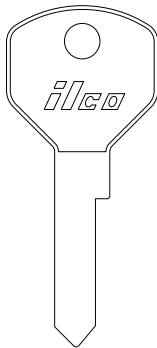

1125H

-

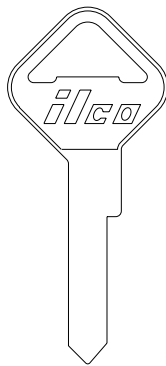

1125K

-

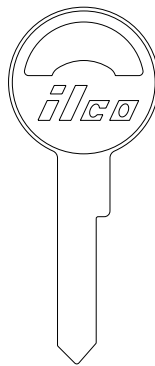

1125M

-

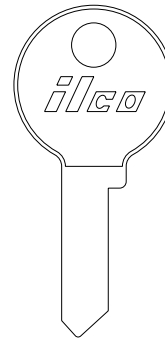

D1125

-

ILCO
EZ

VEHICLE KEYS

FORD

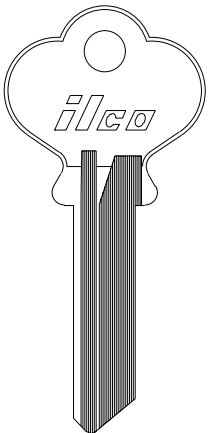

1126M

-

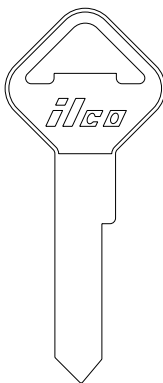

1127
H5

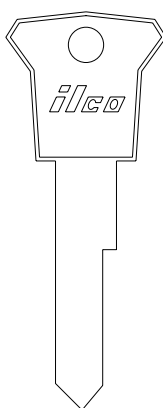

1127B

-

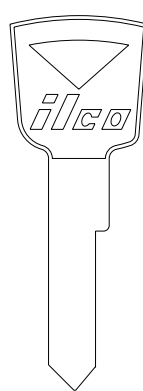

1127D

-

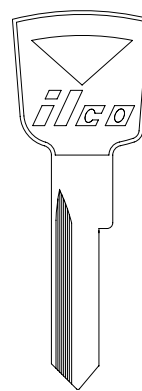

1127DP
H27

ILCO
EZ

FORD

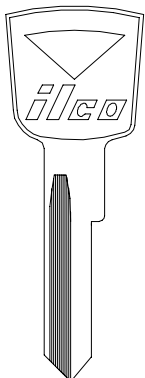

1127DU
H18

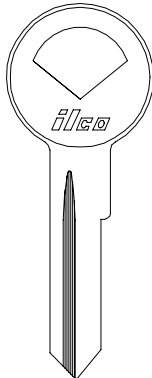

1127ES
H26

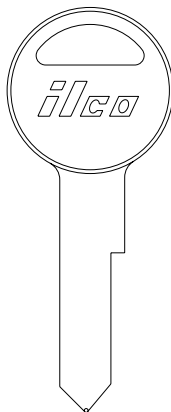

1127F

-

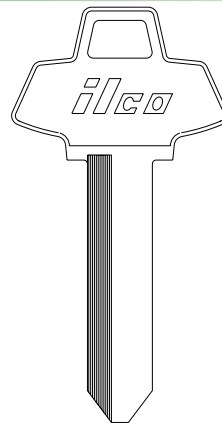

1127FD

-

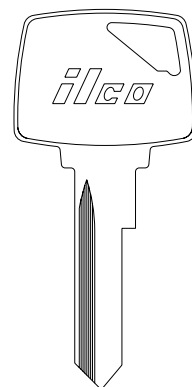

1127FL

-

ILCO
EZ

FORD

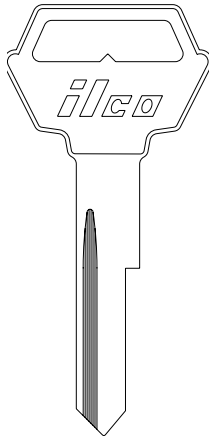

ILCO
EZ 1127FR
-

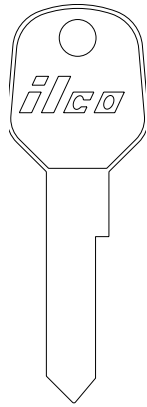

1127H
-

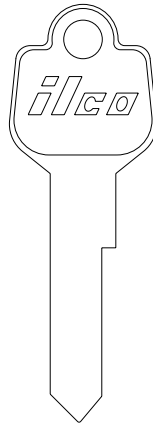

1127J
-

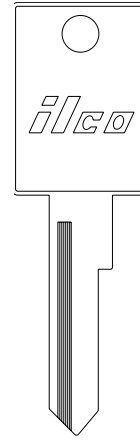

1127K
-

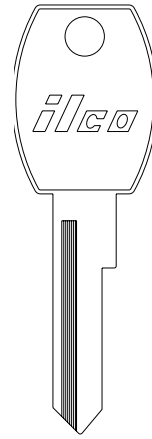

1127L
-



FORD

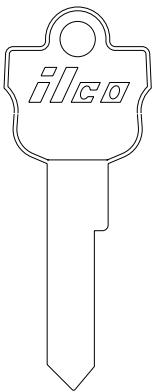

ILCO
EZ 1127M
-

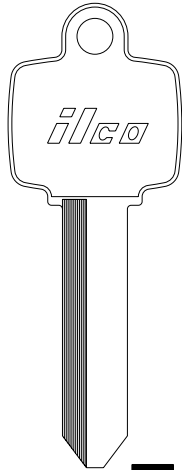

1127ME
-

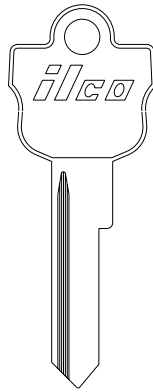

1127MP
-

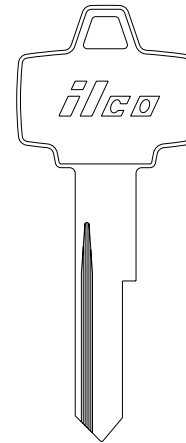

1127MU
-

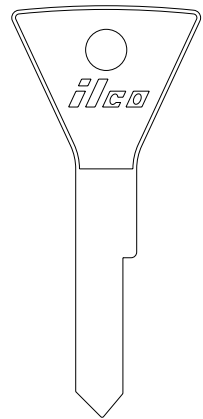

1127N
-

FORD

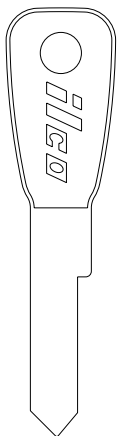

ILCO
EZ 1127P
-

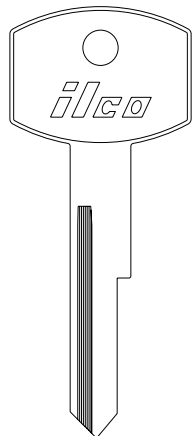

1127T
-

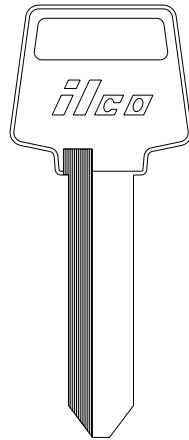

1127TB
-

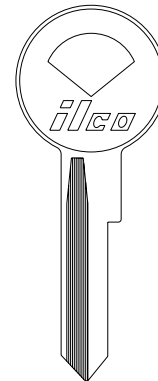

M1127A
-

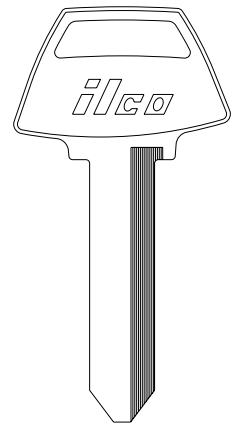

S1127FD
-



FORD

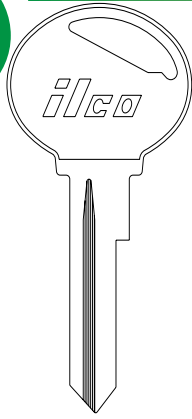

S1127FL
-

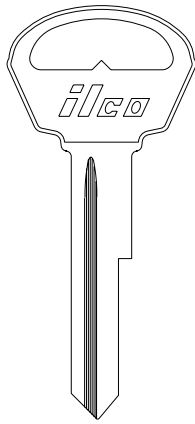

S1127FR
-

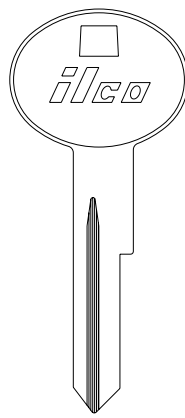

S1127LC
-

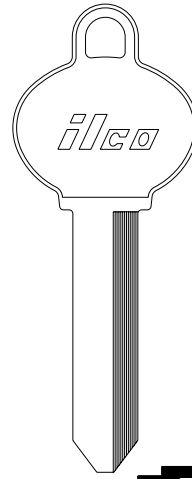

S1127ME
-

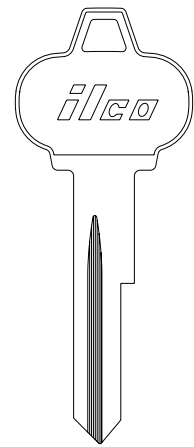

S1127MU
-

ILCO
EZ

FORD

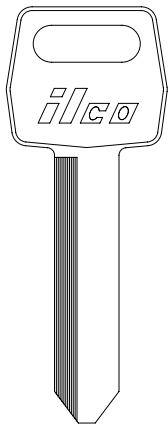

1167FD
H51

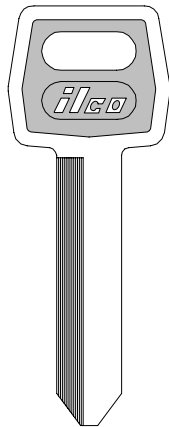

H51-PC
-

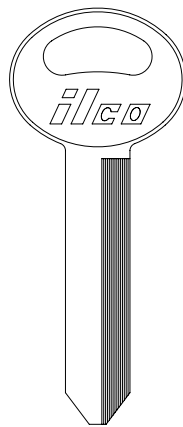

S1167FD
H50

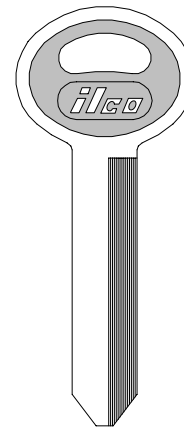

H50-PC
-

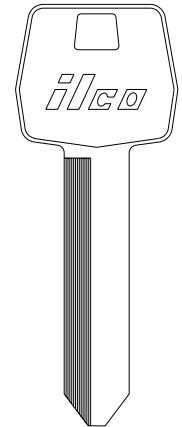

1170LN
-

ILCO
EZ

FORD

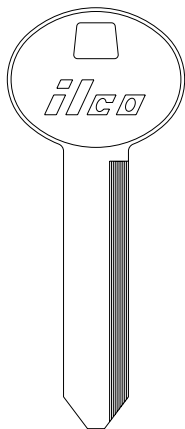

S1170LN
-

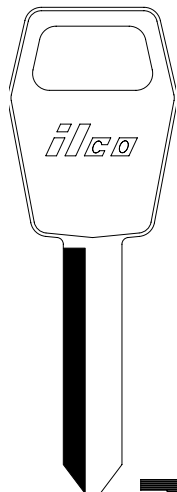

1181FD
H53

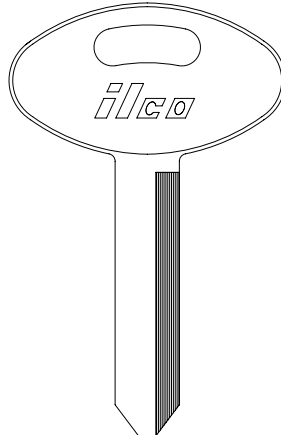

S1181FD
H52

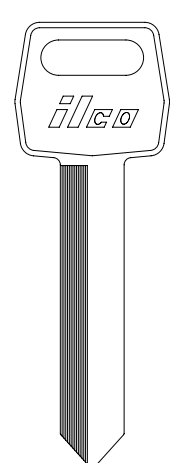

1184FD
H54

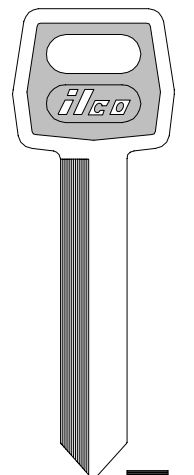

H54-PC
-

ILCO
EZ

VEHICLE KEYS

FORD

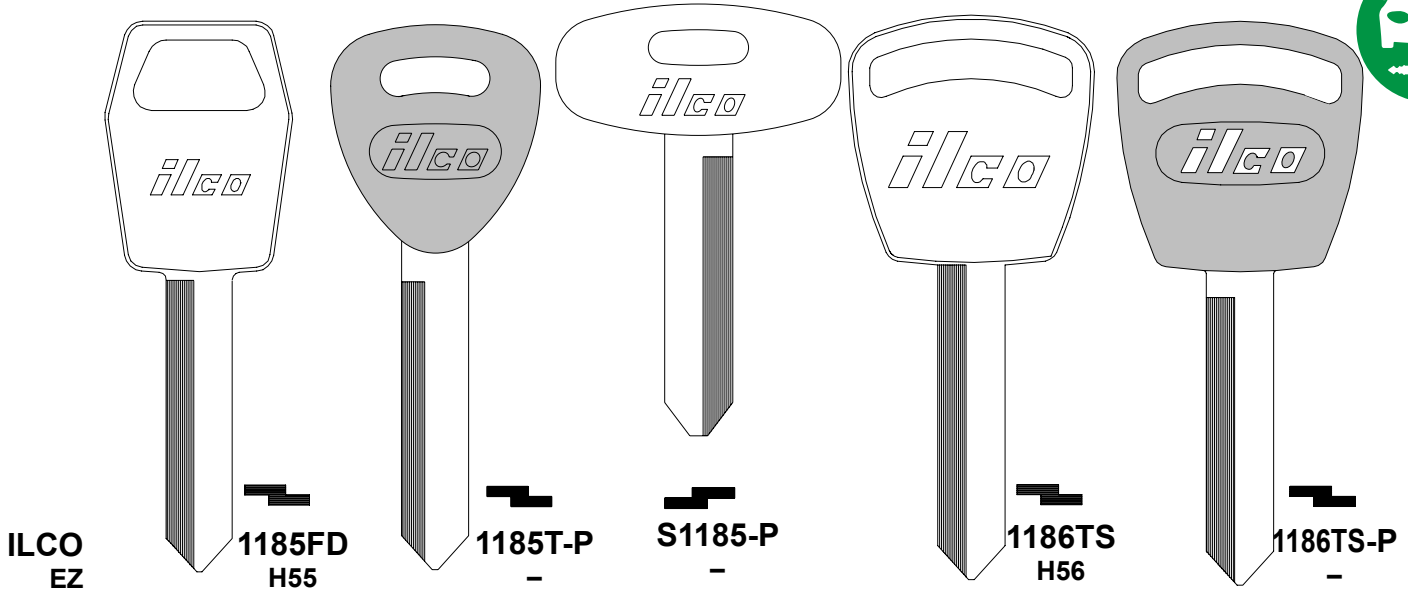

FORD

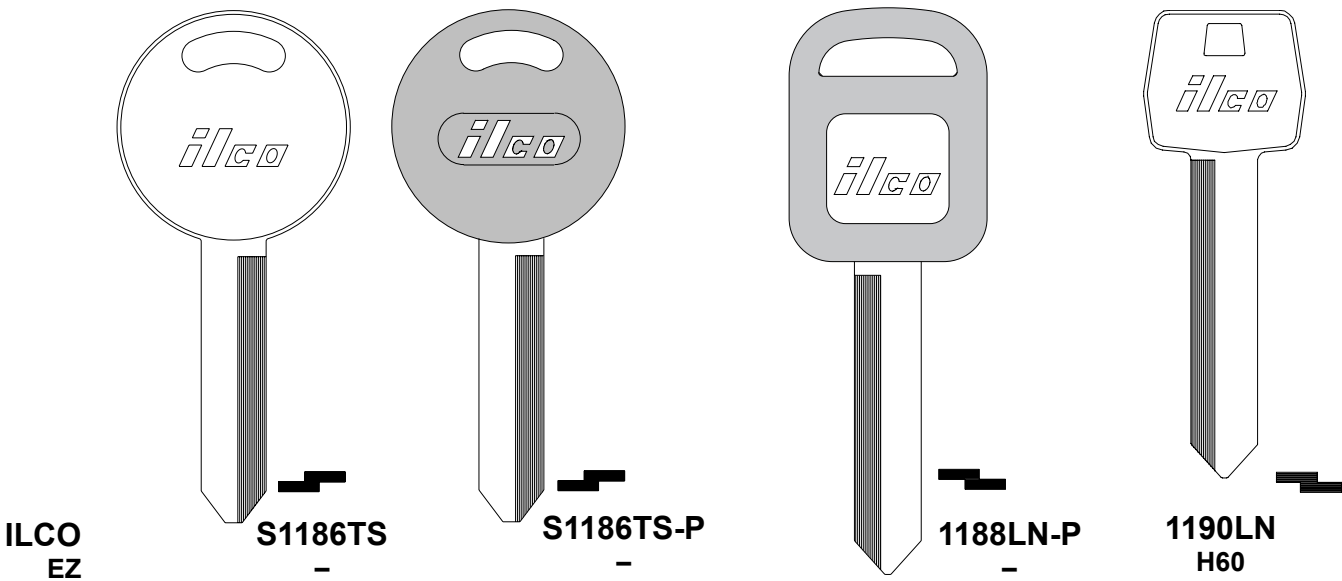

FORD

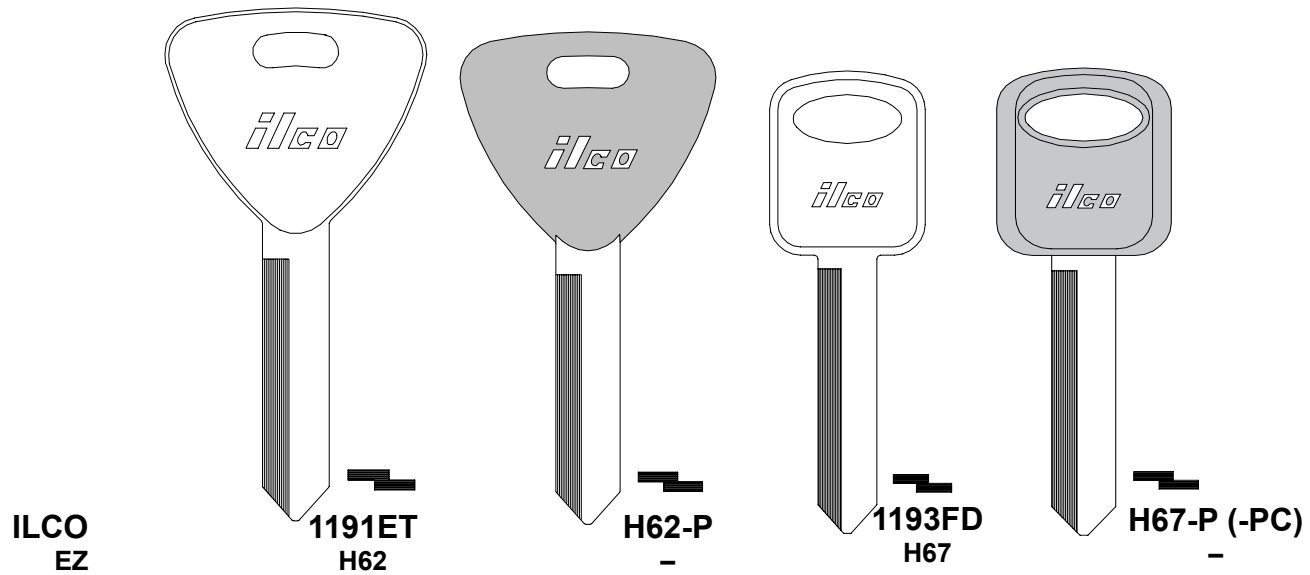



FORD

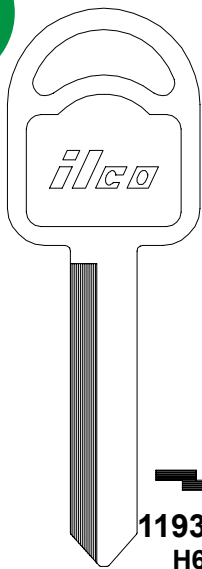

1193MU
H66

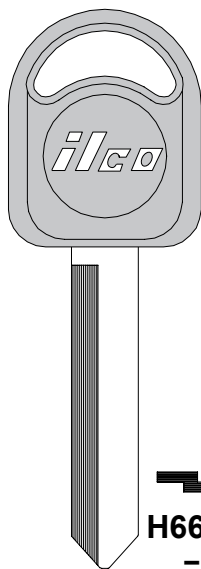

H66-P
-

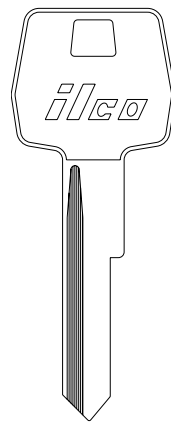

1761LP
-

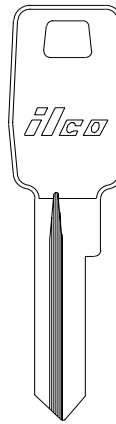

1761LS
-

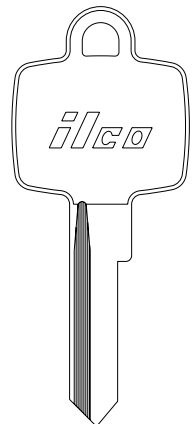

1761MP
-

ILCO
EZ

VEHICLE KEYS

FORD

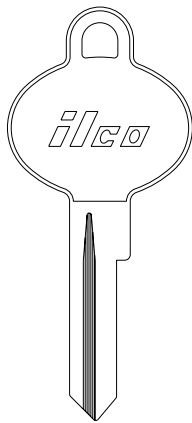

1761MS
-

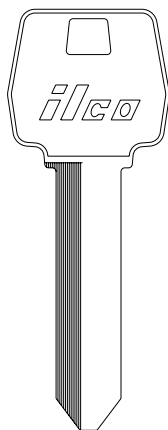

1766LN
-

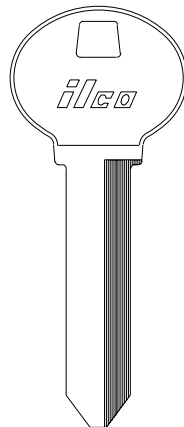

S1766LN
-

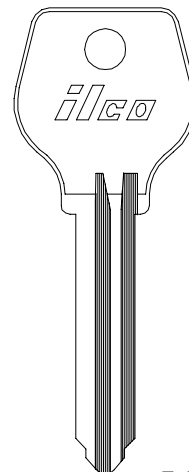

X4
MZ4

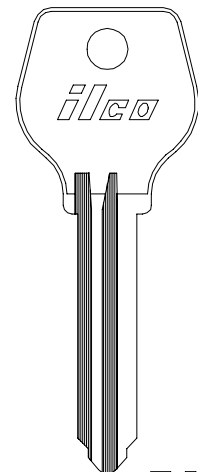

X5
MZ5

ILCO
EZ

FORD

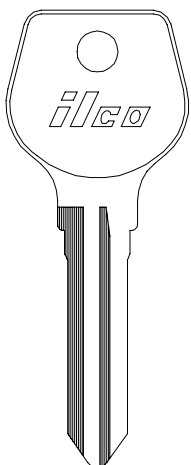

X26
MZ9

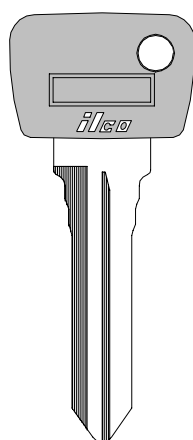

MZ9-P
-

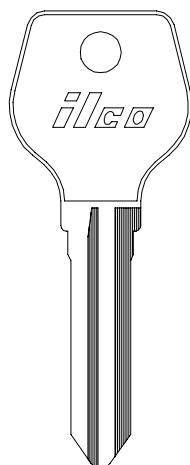

X27
MZ10

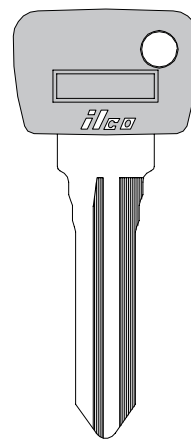

MZ10-P
-

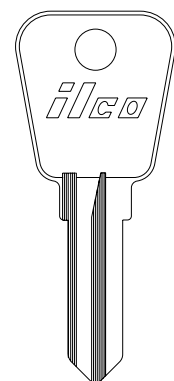

62FT
F68YT

ILCO
EZ

FORD

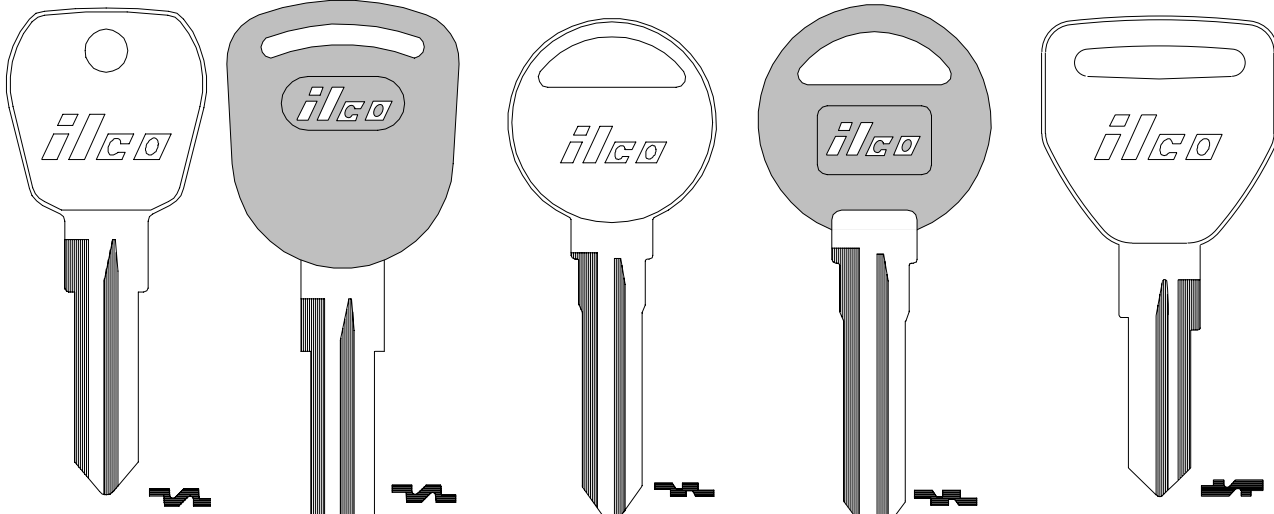

ILCO
EZ

X86
FC7

FC7-P
-

X131
MZ13

MZ13-P (-PC)
-

X169
WB3

FORD

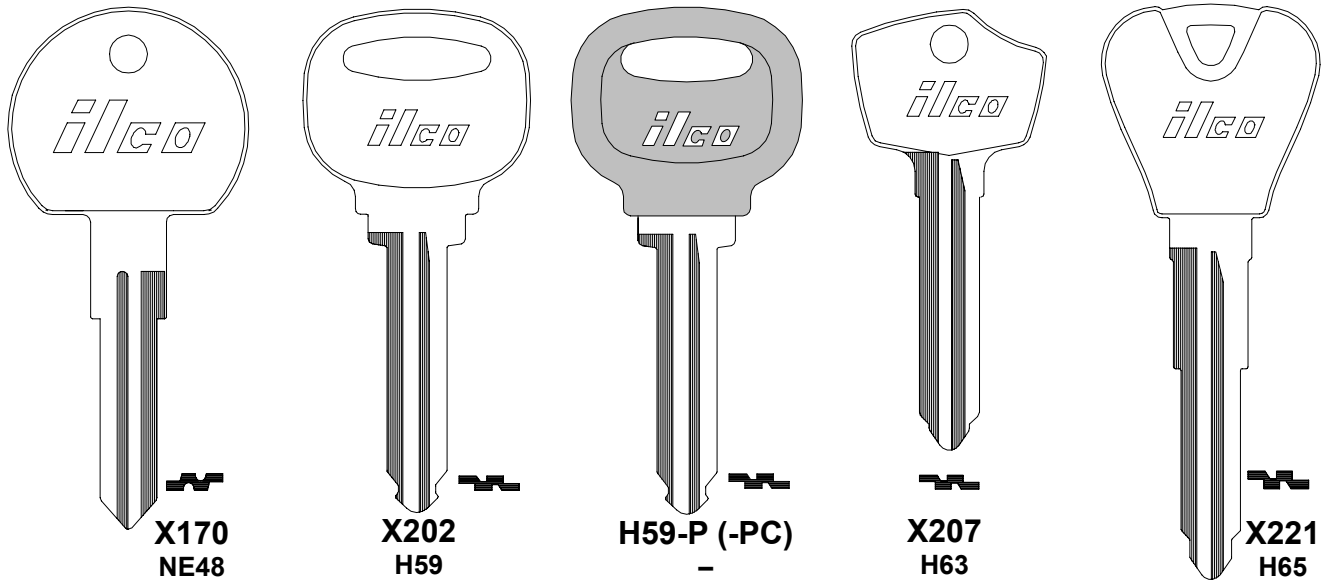

ILCO
EZ

X170
NE48

X202
H59

H59-P (-PC)
-

X207
H63

X221
H65

FORD

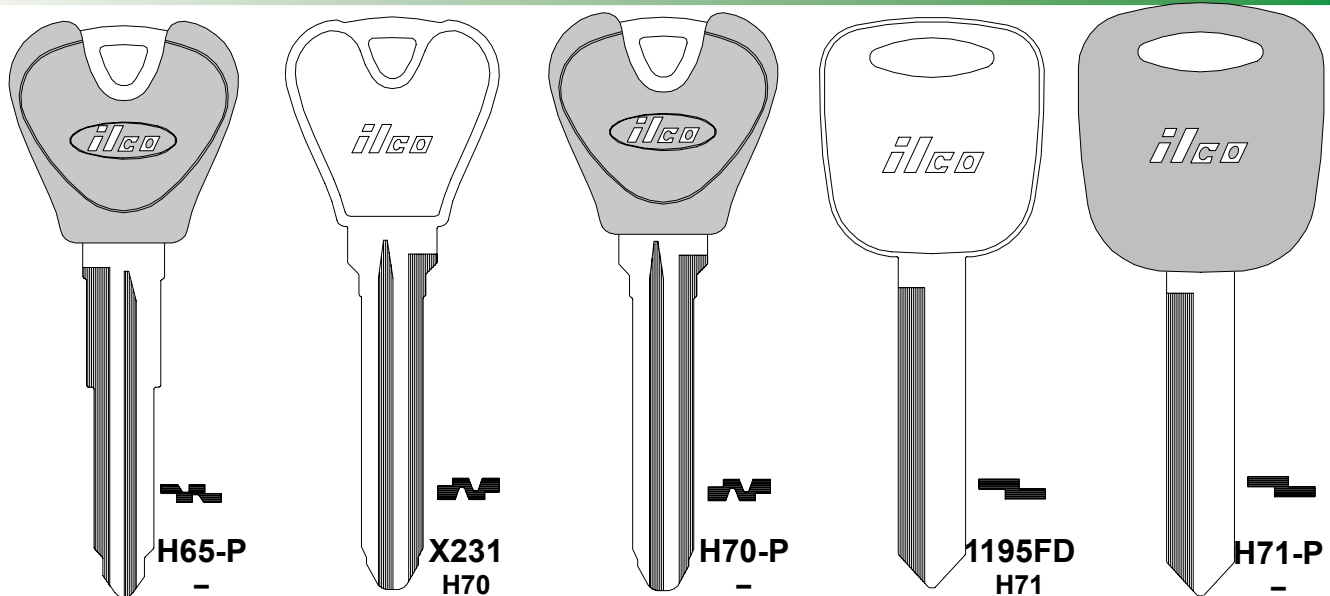

ILCO
EZ

H65-P
-

X231
H70

H70-P
-

1195FD
H71

H71-P
-



FORD

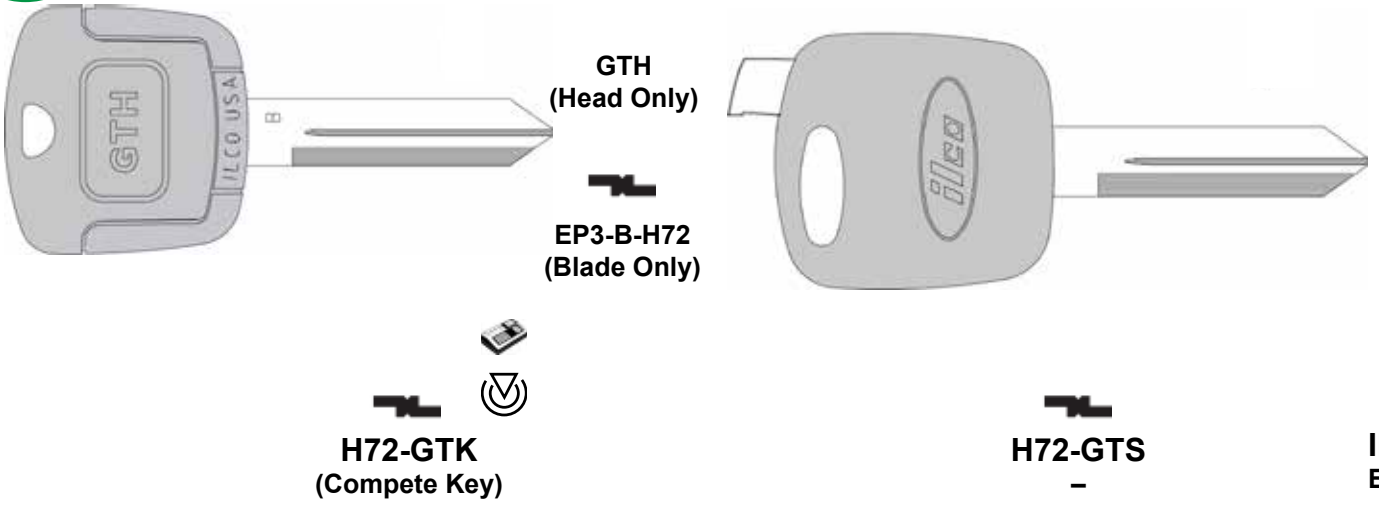

VEHICLE KEYS

FORD

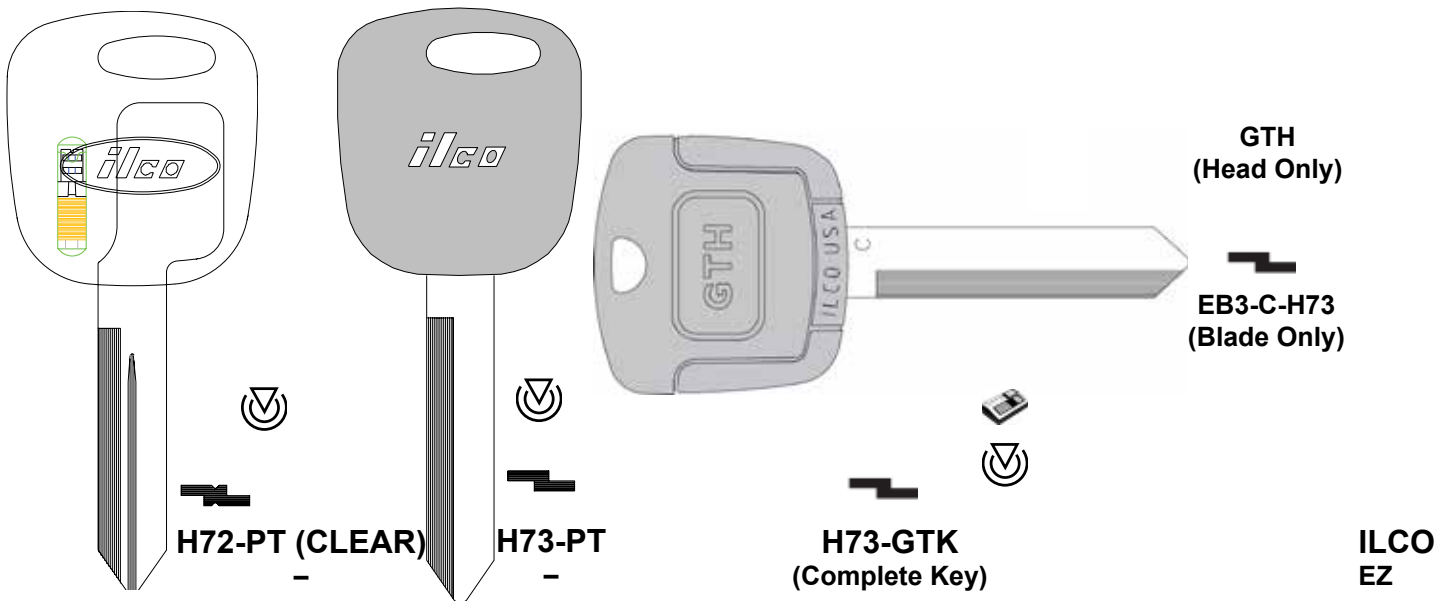

FORD

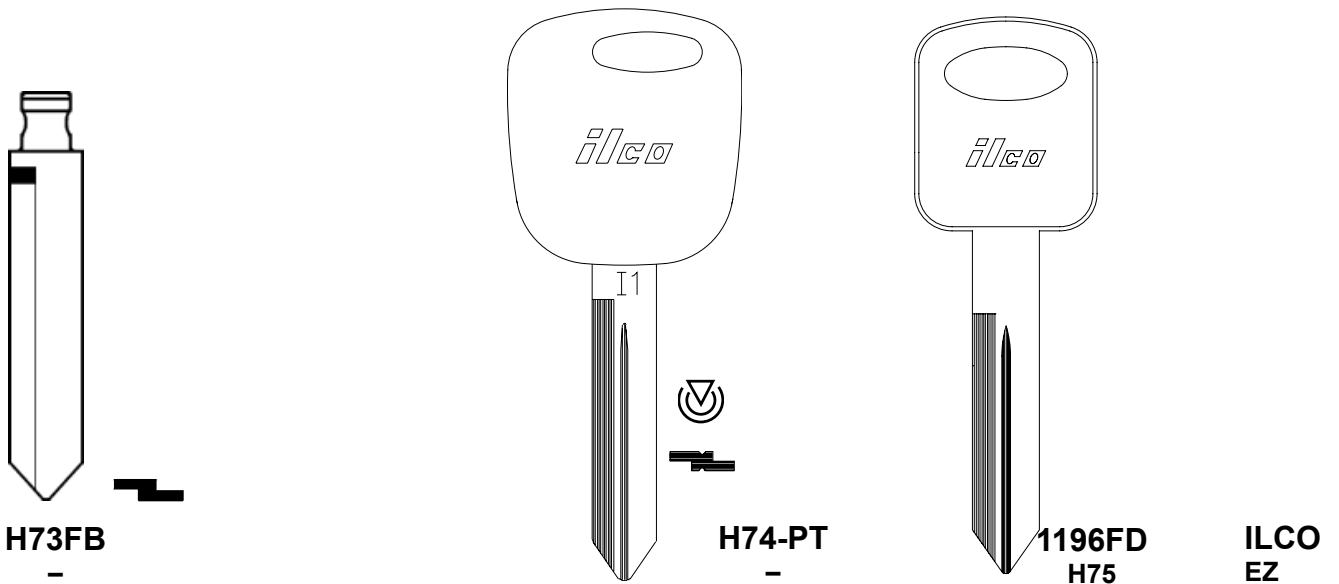



FORD

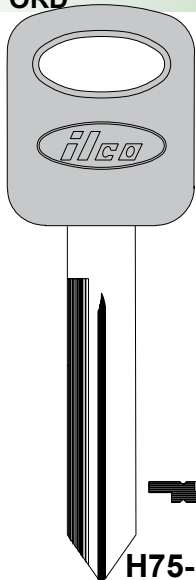

ILCO
EZ

H75-P (-PC) 1196V

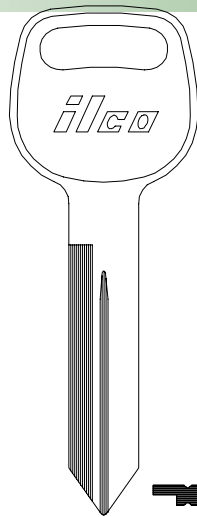

VALET FOR 1196FD & H75-PC (-PC)

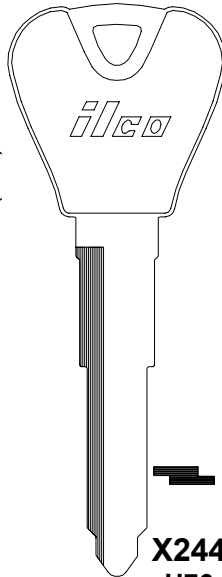

X244
H76

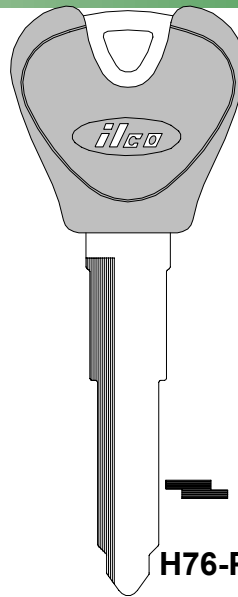

H76-P

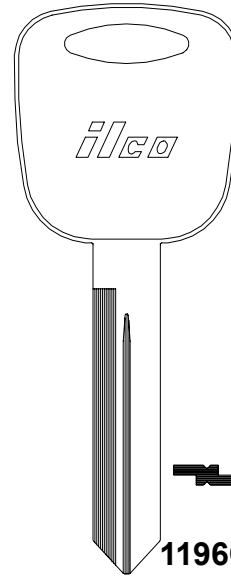

1196CM
H78

FORD

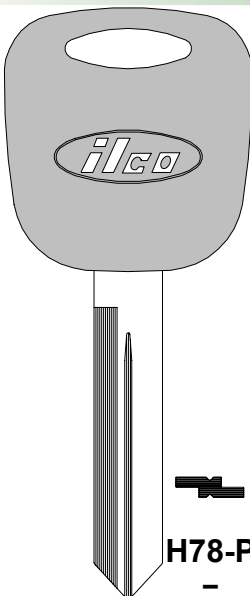

ILCO
EZ

H78-P

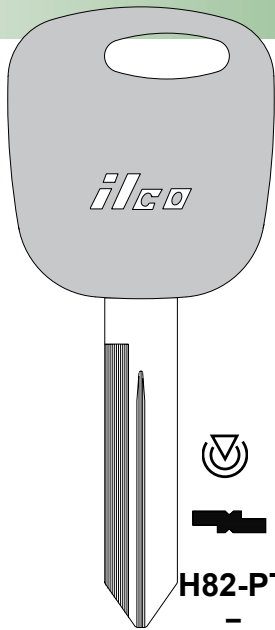

H82-PT

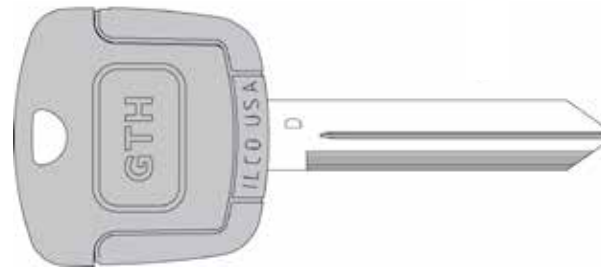

H84-GTK
(Complete Key)

GTH
(Head Only)

EB3-D-H84
(Blade Only)

FORD

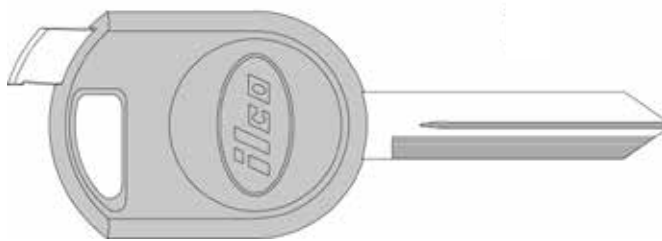

ILCO
EZ

H84-GTS

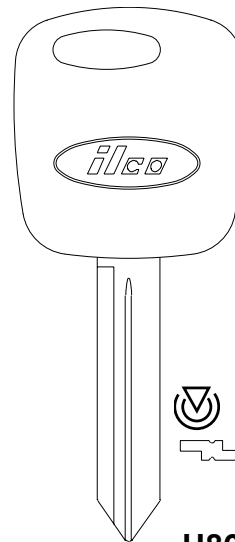

H86-PT

VEHICLE KEYS





FORD

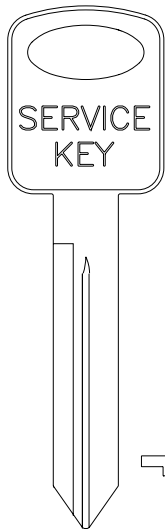

H86-SERVICE KEY

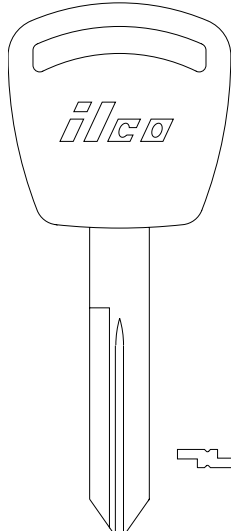

H87-P

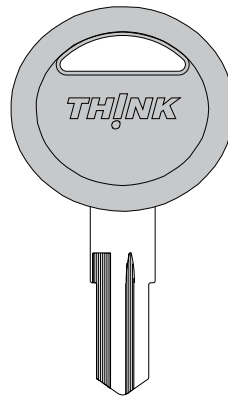

TH1-P

ILCO
EZ

VEHICLE KEYS

FORD

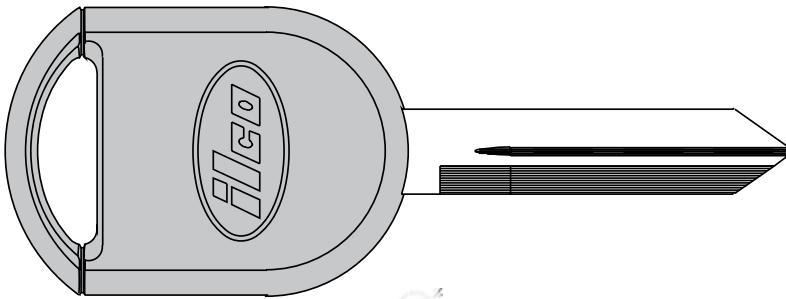

H92-PT

ILCO
EZ

FORD

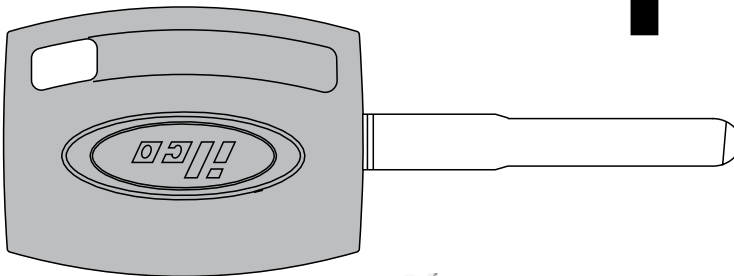

H94-PT



H128-PT

ILCO
EZ

SEC 1

PG 84



FORD

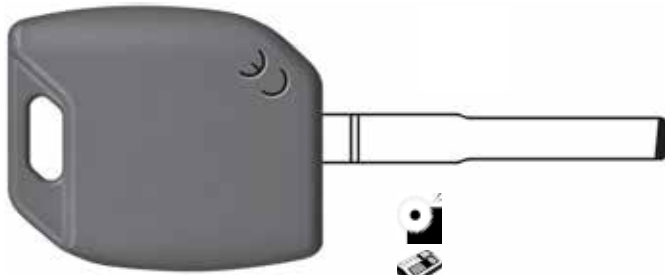

ILCO
EZ

HU101MH
-



HU101 EMER
-

FORD



ILCO
EZ

HU101-GTS
-



HU101T
-

FORD



ILCO
EZ

HU101FB
-

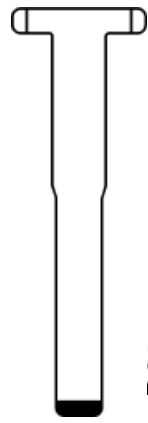

HU198T
-

VEHICLE KEYS





FORD

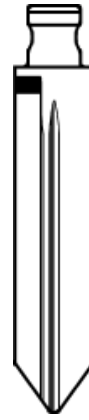

H75 EMER

-

H72FB/H84FB/H92FB

-

ILCO
EZ

VEHICLE KEYS

FORD

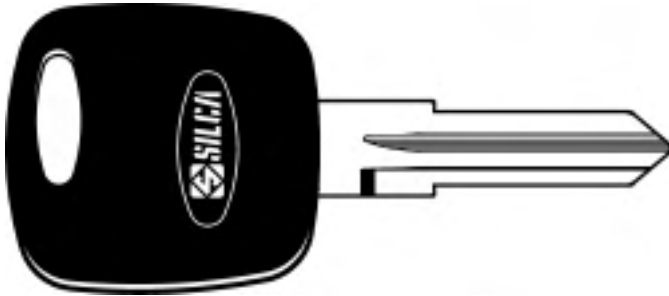

FO10-GTS

-

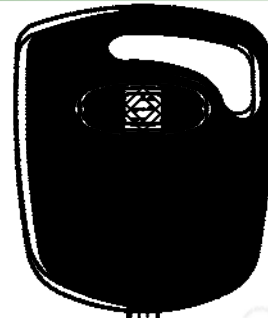

FO21T17

-

ILCO
EZ

FORD



FO21MH

-



FO21-GTS

-

ILCO
EZ

SEC 1

PG 86



FORD

FORD INTERNATIONAL

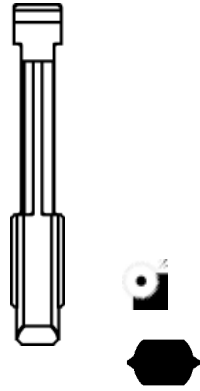

ILCO
EZ

FO21FB
-

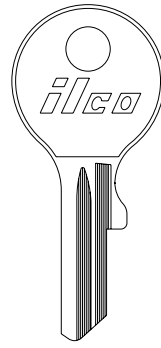

BU1
-

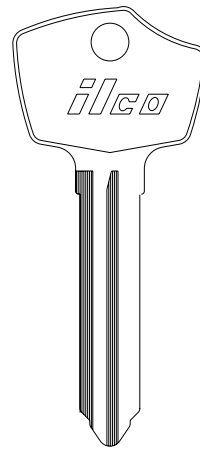

BU2
-

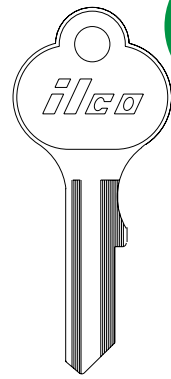

FF1
-



VW1
-

FORD INTERNATIONAL

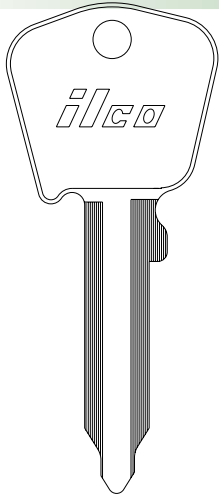

ILCO
EZ

KL2
-

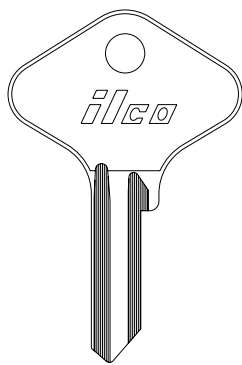

FT5R
-

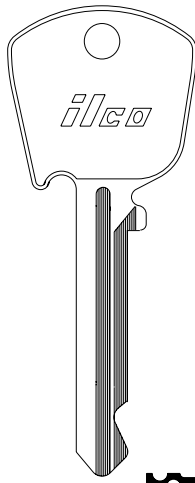

DO3L
-

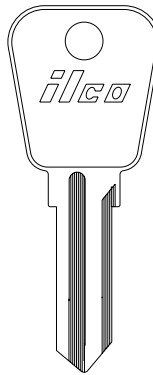

FT3
-

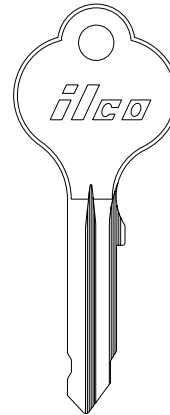

SR3
-

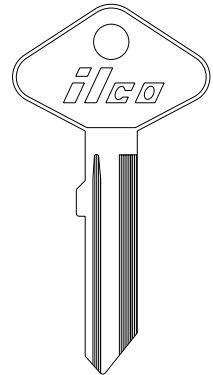

YM3
-

CA4
-

FORD INTERNATIONAL

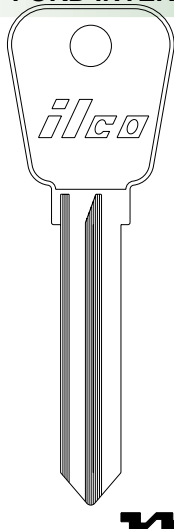

ILCO
EZ

CE4
-

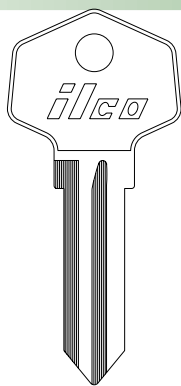

CE6
-

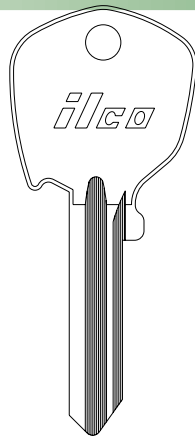

FT6
-

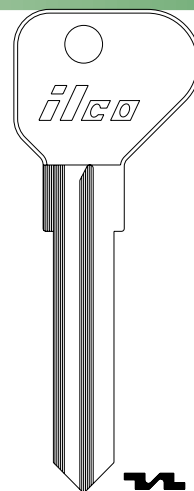

CE7
-

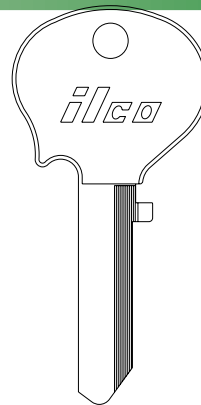

NE7
-

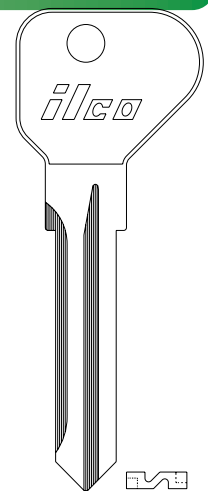

CE8
-

VEHICLE KEYS





FORD INTERNATIONAL

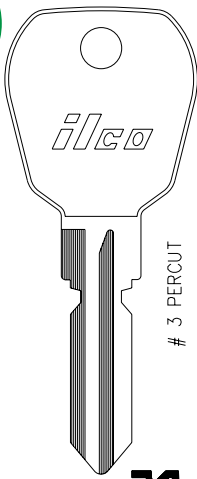

FC8
-

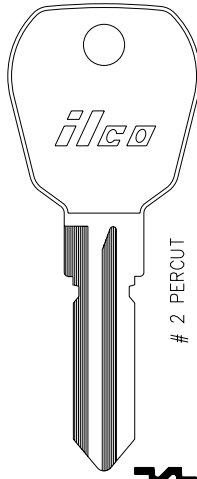

FC9
-

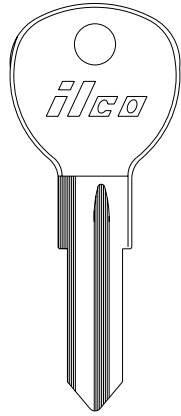

FT10
-

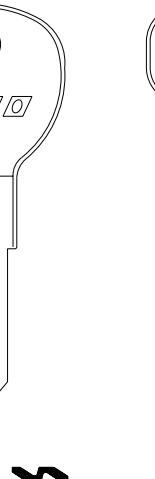

FT10R
-

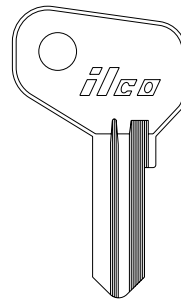

SF11
-

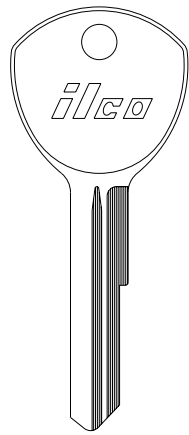

HF12
-

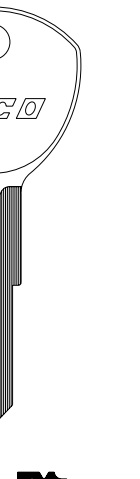

HF13
-

ILCO
EZ

VEHICLE KEYS

FORD INTERNATIONAL

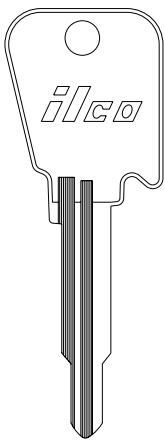

X13
LF4

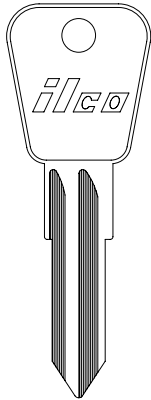

YM15
-

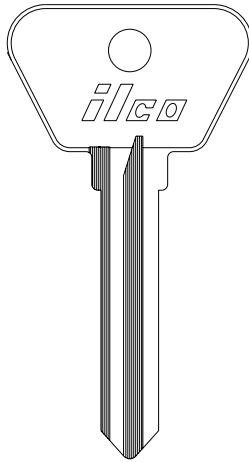

BR20
-

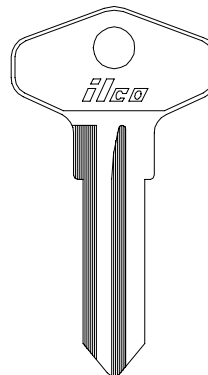

X20
FC2

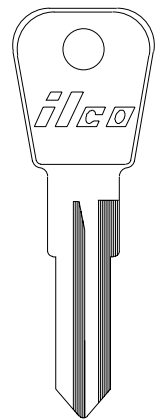

X21
YS1

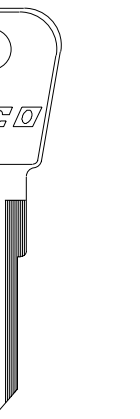

X22
YS2

ILCO
EZ

FORD INTERNATIONAL

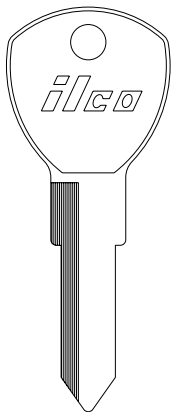

HF22
-

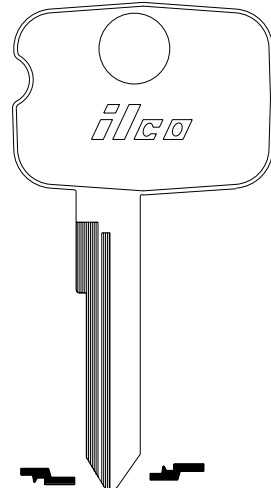

YM29
-

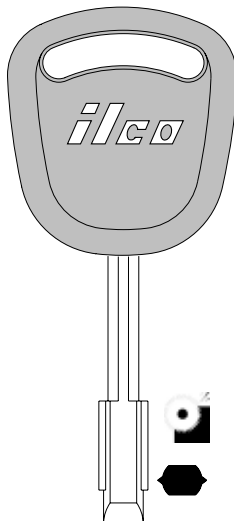

S30FD-P
-

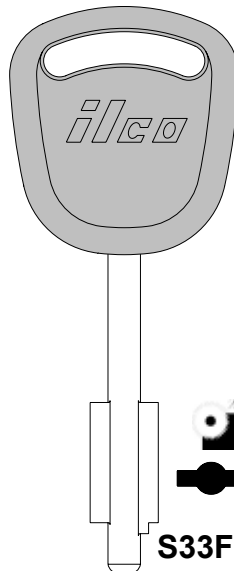

S33FD-P
-

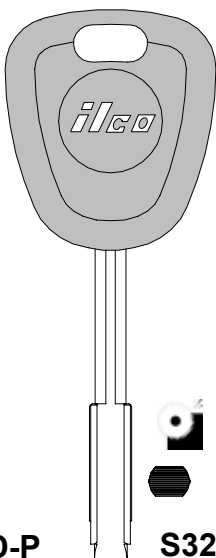

S32FJ-P
-

ILCO
EZ

FORD INTERNATIONAL

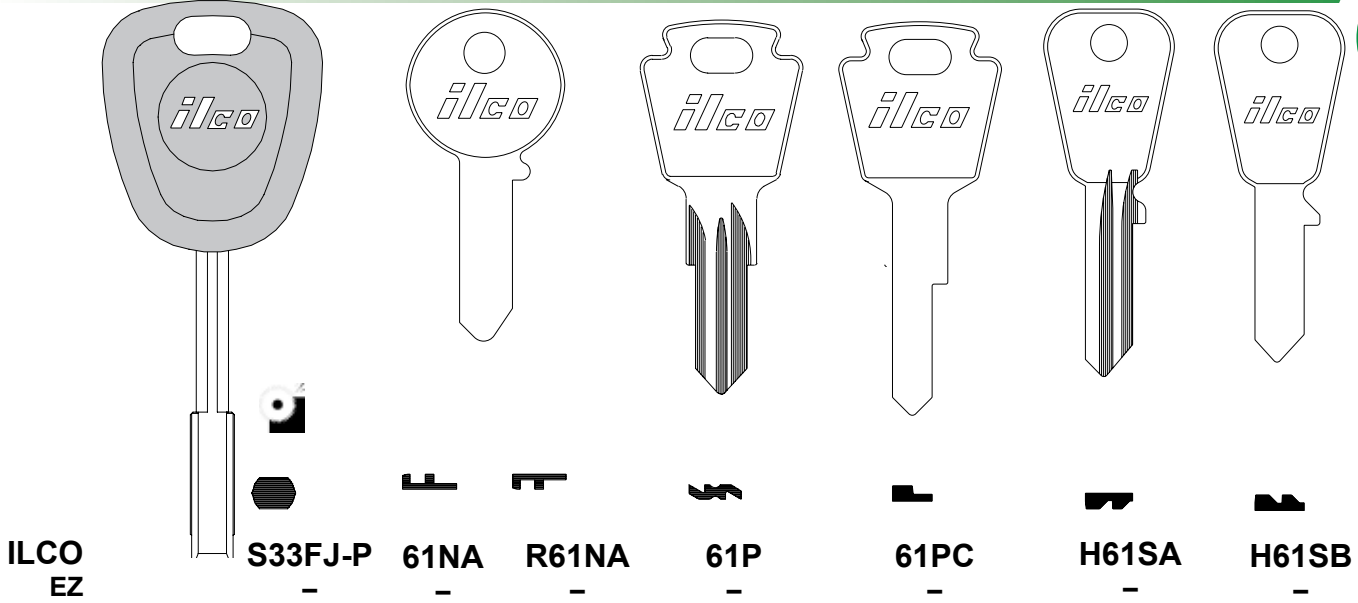

ILCO EZ S33FJ-P 61NA R61NA 61P 61PC H61SA H61SB

FORD INTERNATIONAL

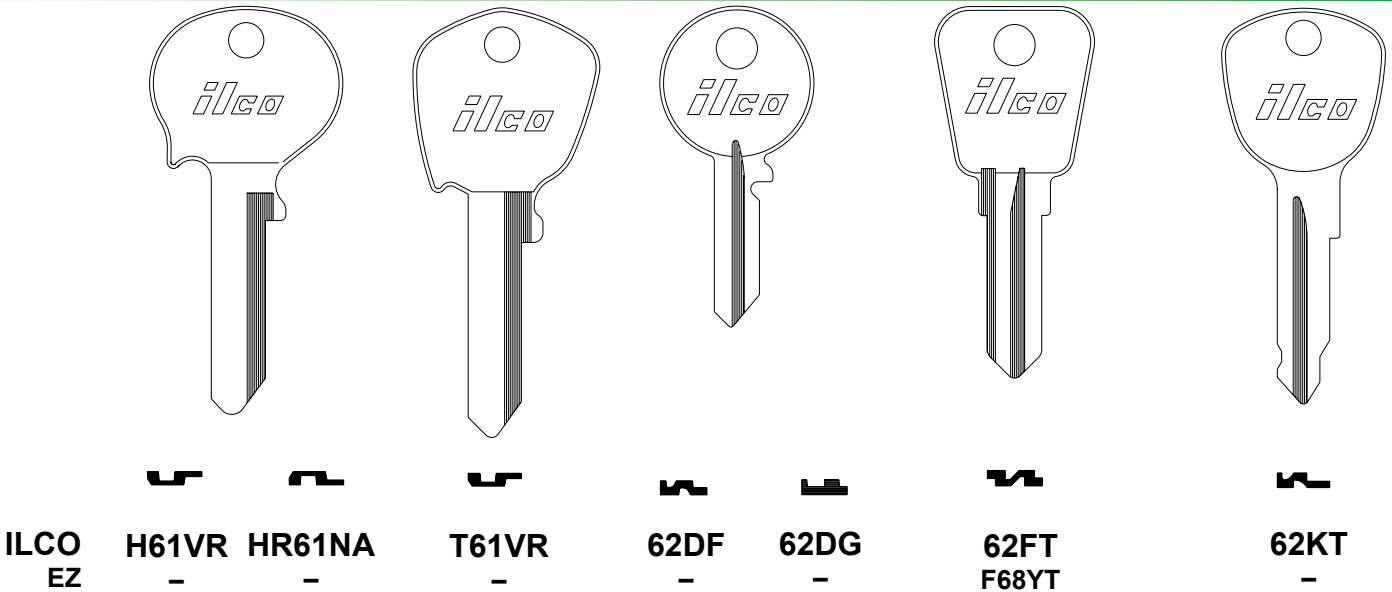

ILCO EZ H61VR HR61NA T61VR 62DF 62DG 62FT F68YT 62KT

FORD INTERNATIONAL

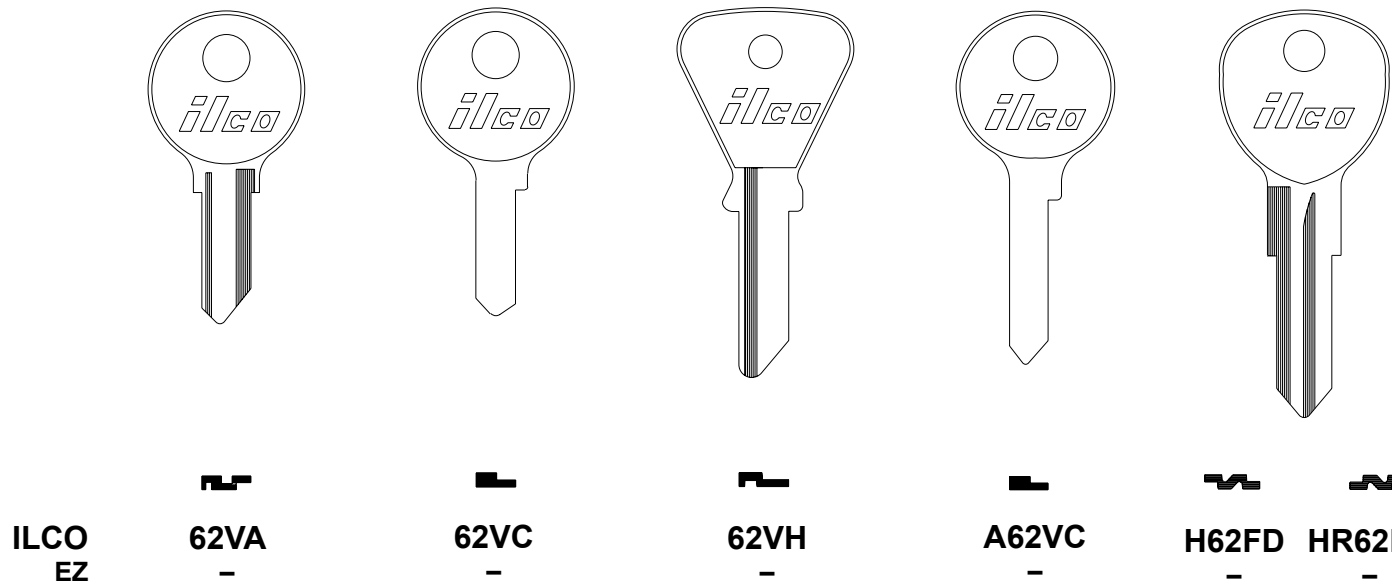

ILCO EZ 62VA 62VC 62VH A62VC H62FD HR62FD

VEHICLE KEYS





FORD INTERNATIONAL

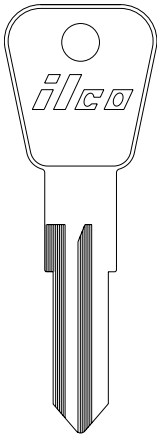

L62FD
-

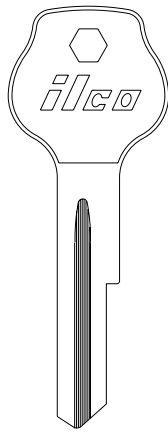

LR62VB
-

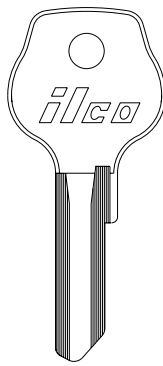

R63Y
-

R62VB
-

G63Y
-

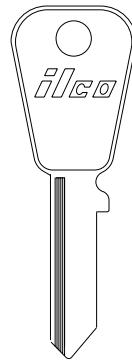

S62DP
-

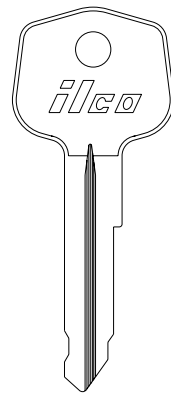

63E
-

R63E
-

ILCO
EZ

VEHICLE KEYS

FORD INTERNATIONAL

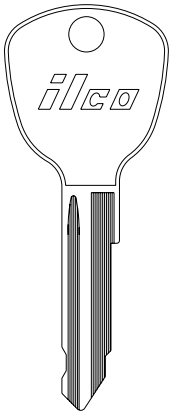

R63KE
-

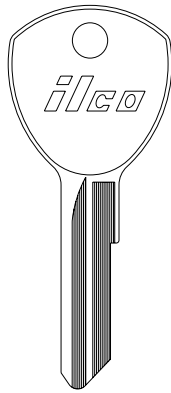

R63TK
-

R63TY
-

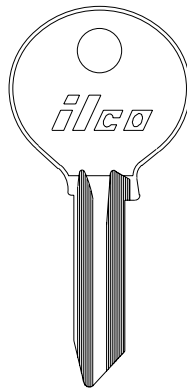

H64E
-

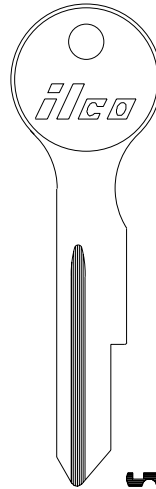

65J
-

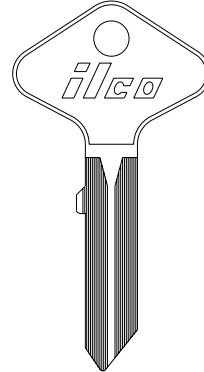

65T
-

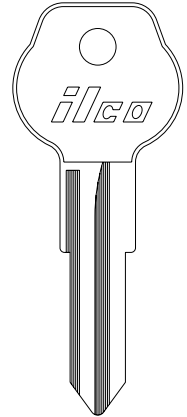

F76M
-

ILCO
EZ

FORD INTERNATIONAL

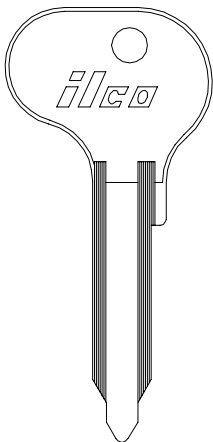

VW77
-

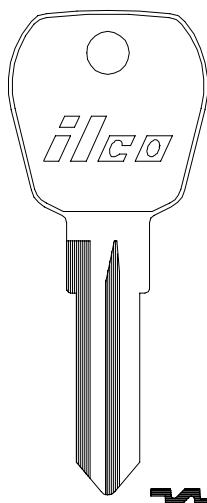

X86
FC7

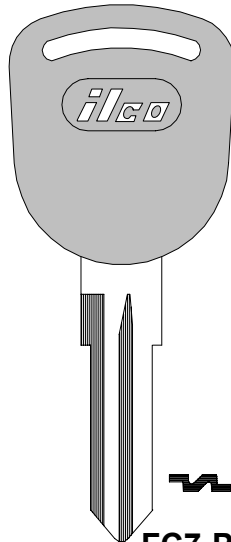

FC7-P
-

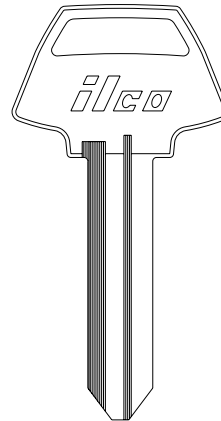

P1127C
-

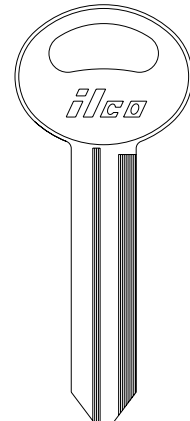

S1127C
-

ILCO
EZ

FORD AUSTRALIA

FORD TRACTOR

FORD TRUCK COVER

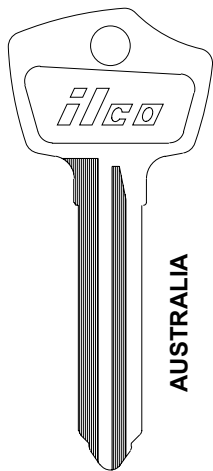

AUSTRALIA



ILCO
EZ

FF2

-

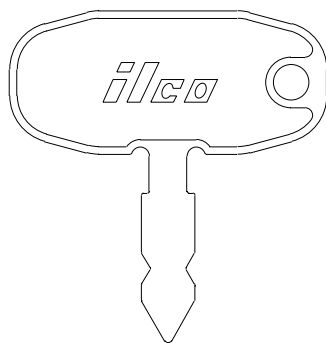

1569

-

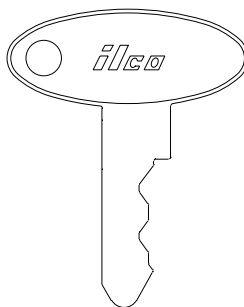

1570

-

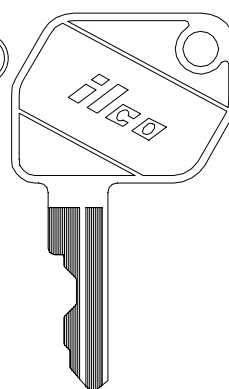

1592

-

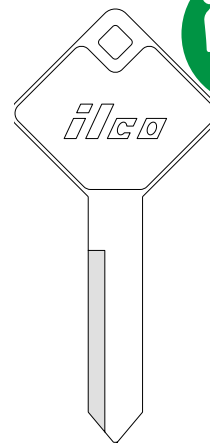

1660

-

FREIGHTLINER

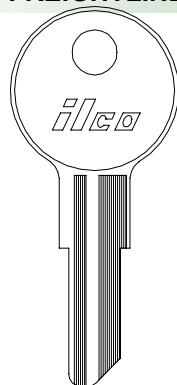

ILCO
EZ

1041T
CG16

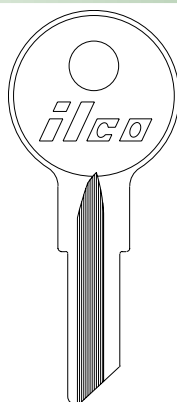

1098M
B1

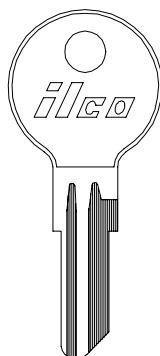

O1122A
Y12

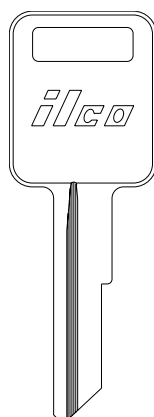

1584

-

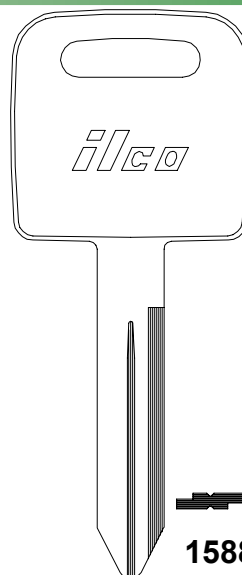

1588

-

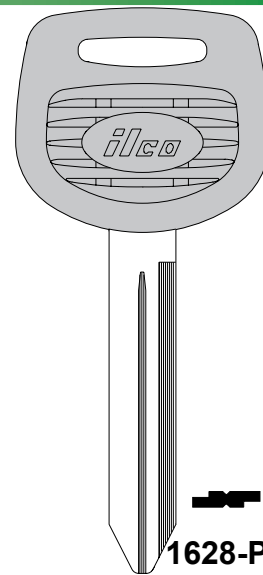

1628-P

-

FREIGHTLINER

GAS CAP LOCK

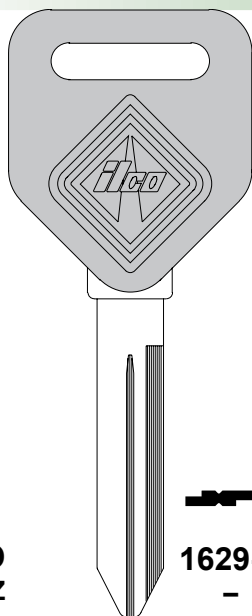

ILCO
EZ

1629-P

-

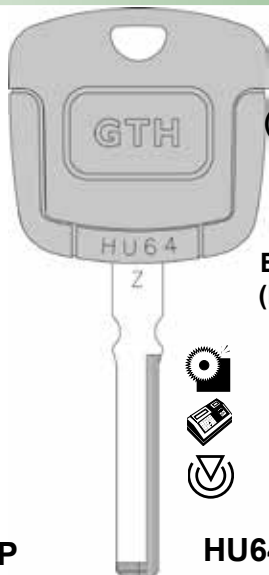

GTH
(Head Only)

EB3-Z-HU64
(Blade Only)



HU64-GTK

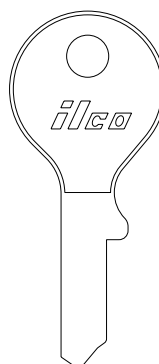

GC1

-

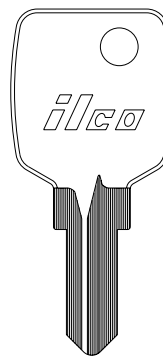

PN1

-

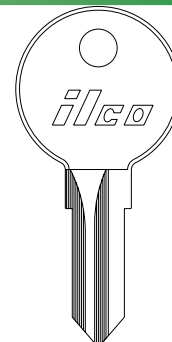

KM3

-



KM6

-



KM2

-





GAS CAP LOCK

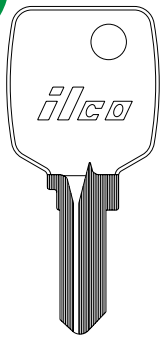

PN2

-

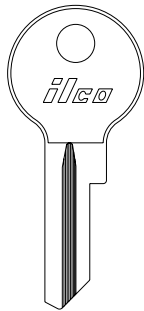

BU3

-

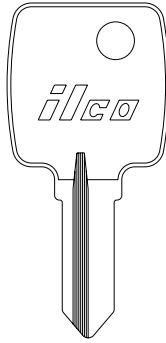

PN3

-

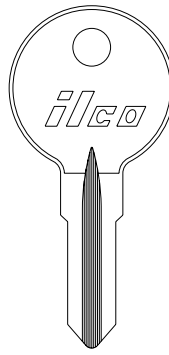

KM4

-

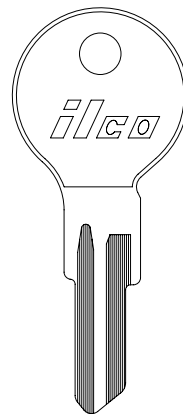

Z4

-

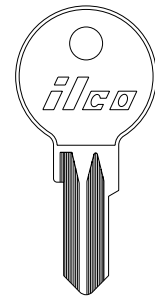

KM5

-



KM7

-

**ILCO
EZ**

VEHICLE KEYS

GAS CAP LOCK

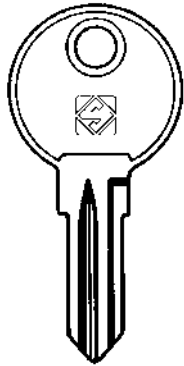

KI10R

-

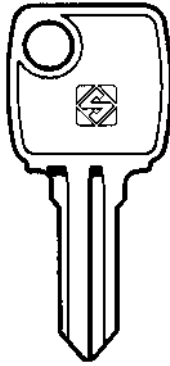

KI17

-

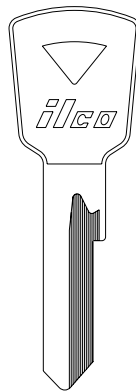

WS10

-

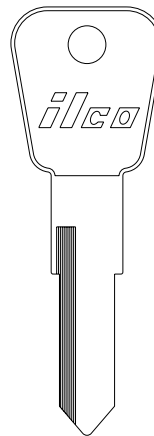

WS11

-

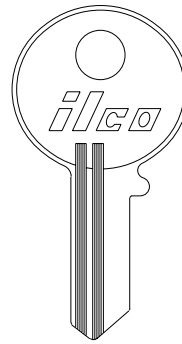

V61S

-

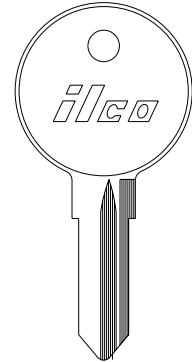

63H

-



R63H

-

**ILCO
EZ**

GAS CAP LOCK

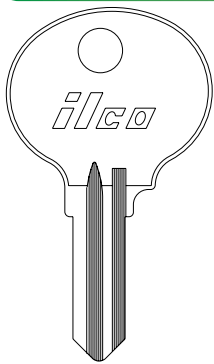

H63G

-

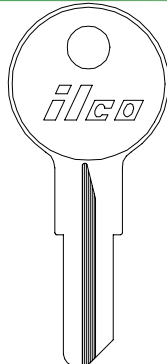

**1098GX
B52**

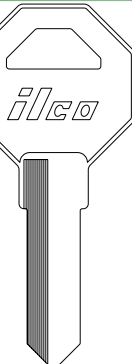

1546

-



1574

-

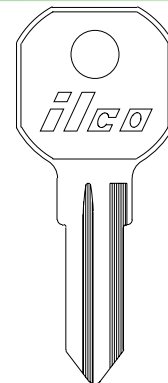

1611

-

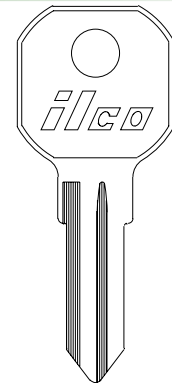

1611R

-







**ILCO
EZ**

SEC
1
PG
92









GENERAL MOTORS

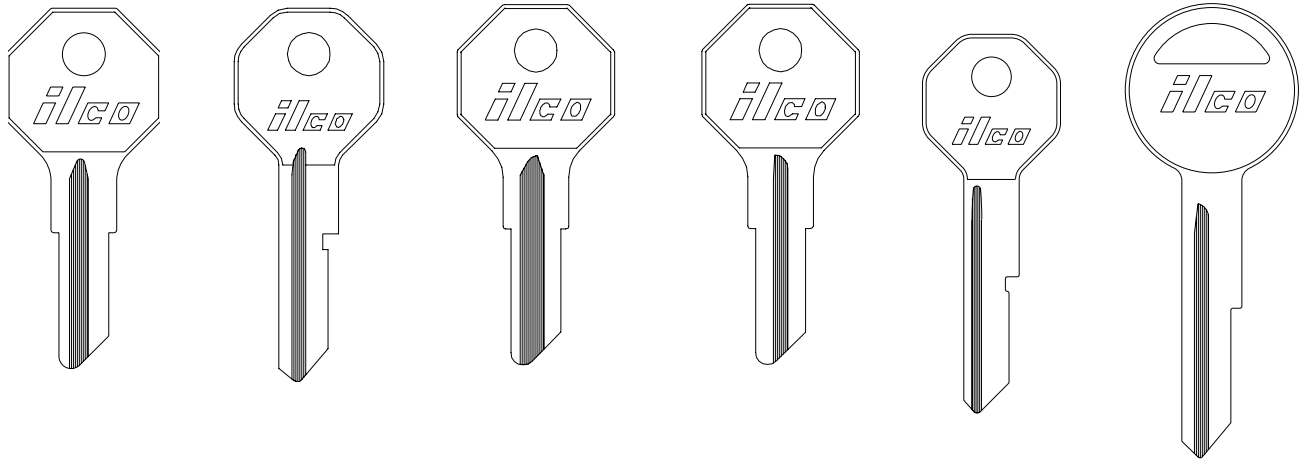

						
ILCO	1098L	1098X	C1098A	H1098A	H1098C	H1098DB
EZ	B3	B52	-	-	-	B16

GENERAL MOTORS



						
ILCO	H1098L	H1098LA	H1098M	H1098X	L1098C	L1098LA
EZ	-	B10	B2	B24	-	-

GENERAL MOTORS

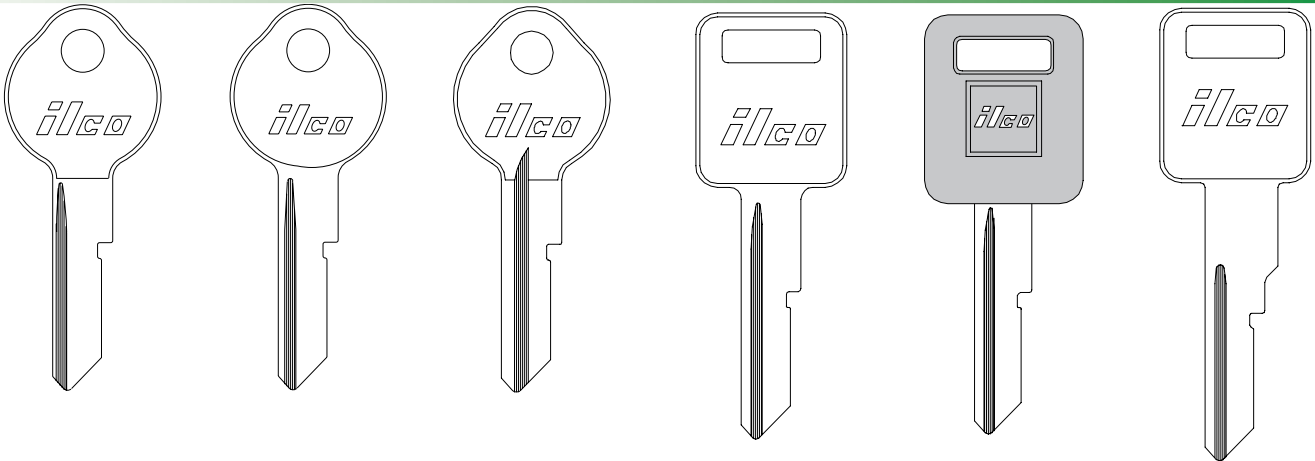

						
ILCO	O1098B	O1098D	O1098LA	P1098A	B48-P (-PC)	P1098AV
EZ	-	B43	B11	B48	-	B62

VEHICLE KEYS





GENERAL MOTORS

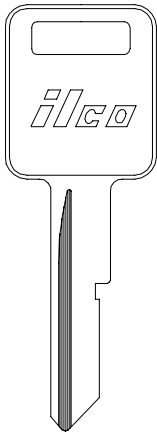

P1098C
B50

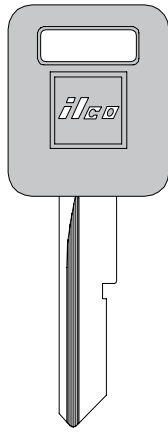

B50-P (-PC)
-

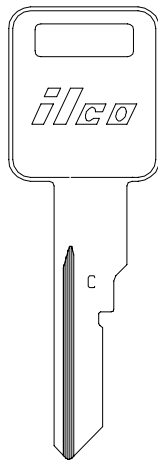

P1098CV
B63

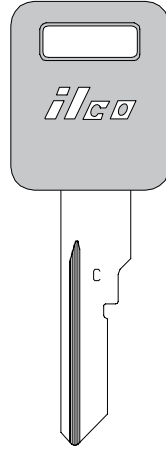

B63-P (-PC)
-

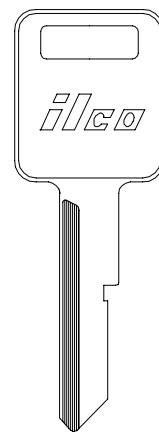

P1098E
B44

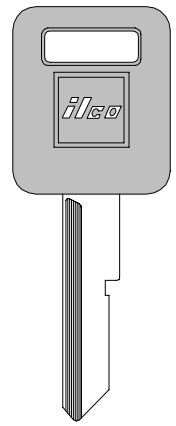

B44-P (-PC) ILCO
EZ

VEHICLE KEYS

GENERAL MOTORS

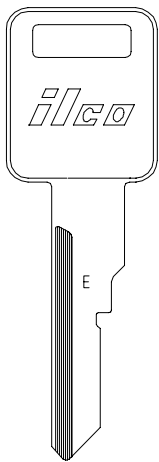

P1098EV
B77

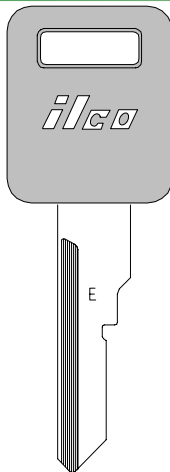

B77-P (-PC)
-

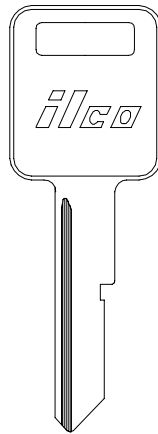

P1098J
B46

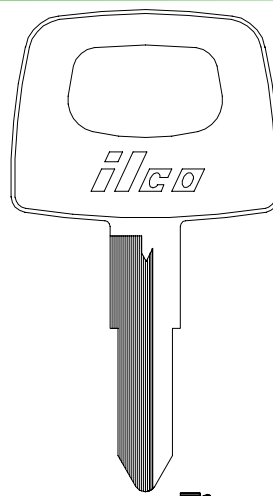

P1098V
LUV1

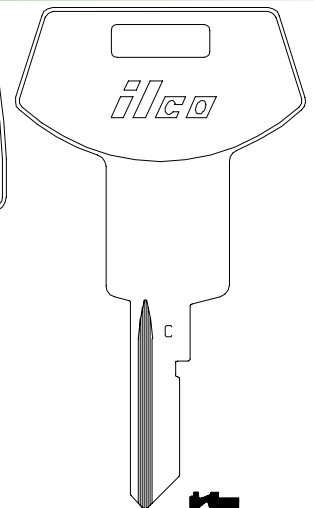

P1098WC
B64

ILCO
EZ

GENERAL MOTORS

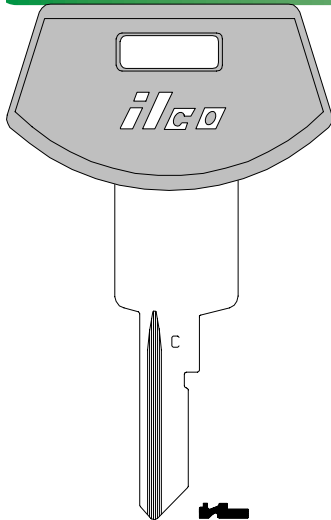

B64-P (-PC)
-

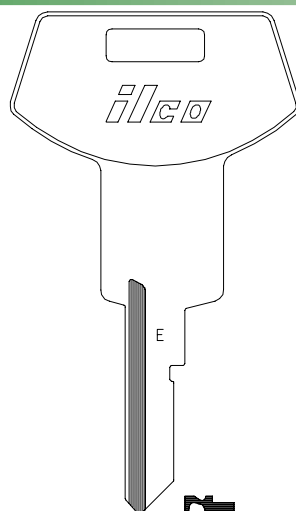

P1098WE
B78

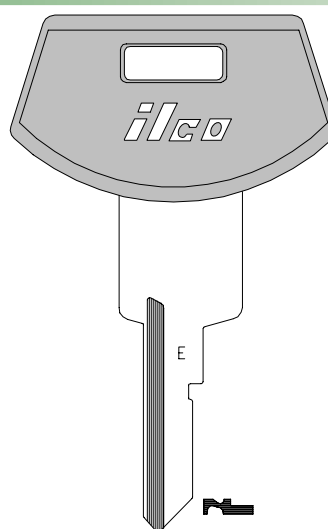

B78-P (-PC)
-

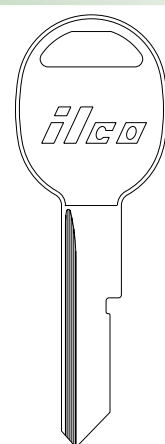





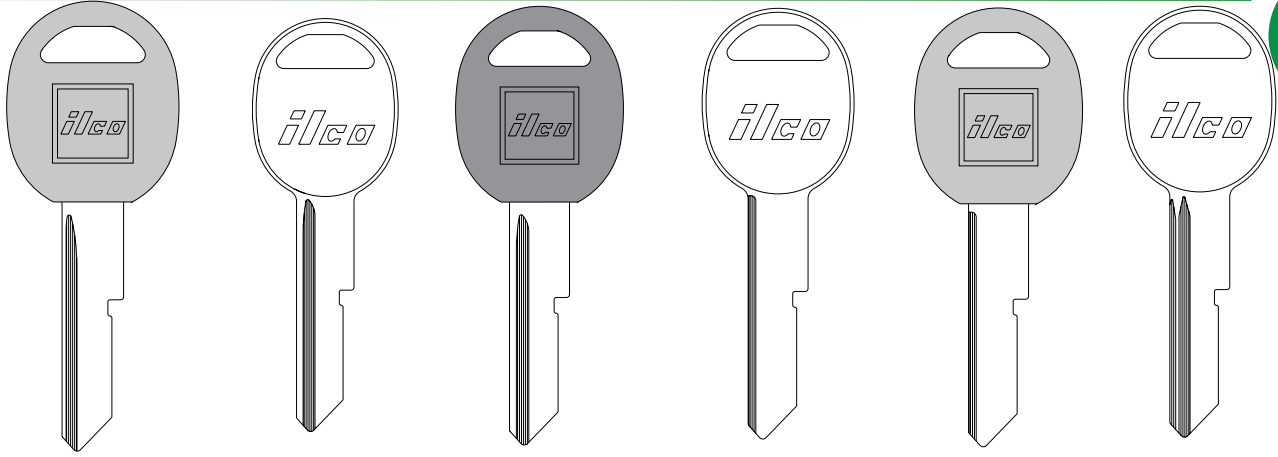

S1098B
B49

ILCO
EZ



GENERAL MOTORS



					
ILCO B49-P (-PC) EZ -	S1098D B51	B51-P (-PC) -	S1098H B45	B45-P (-PC) -	S1098K B47

GENERAL MOTORS

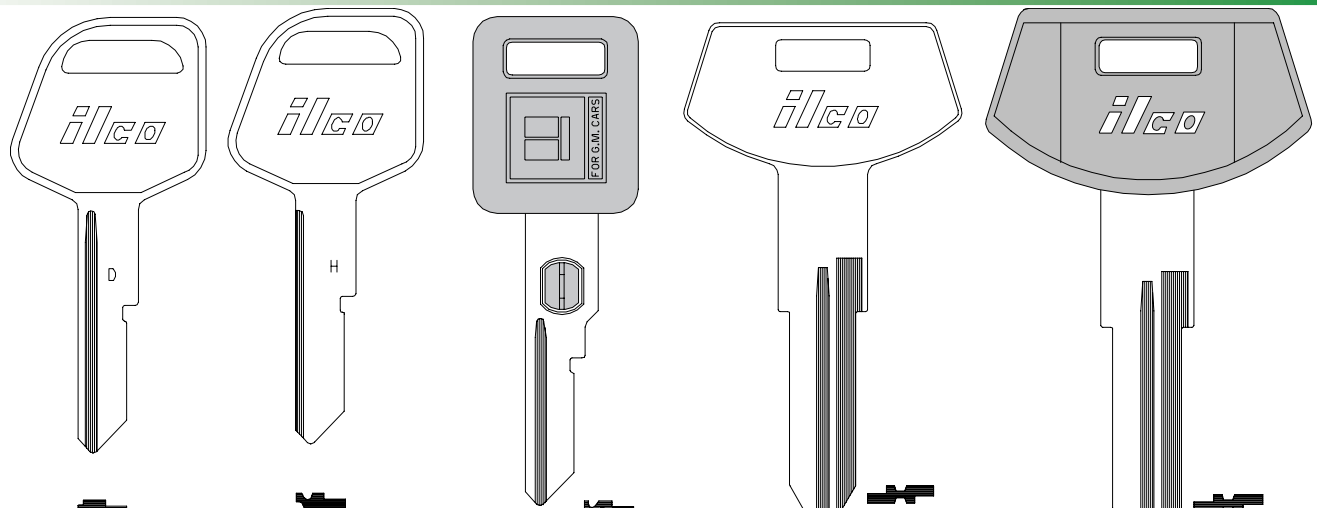

				
ILCO S1098WD EZ B67	S1098WH B79	B62-P-1 thru 15 VATS	P1099 B68	B68-P (-PC) -

GENERAL MOTORS

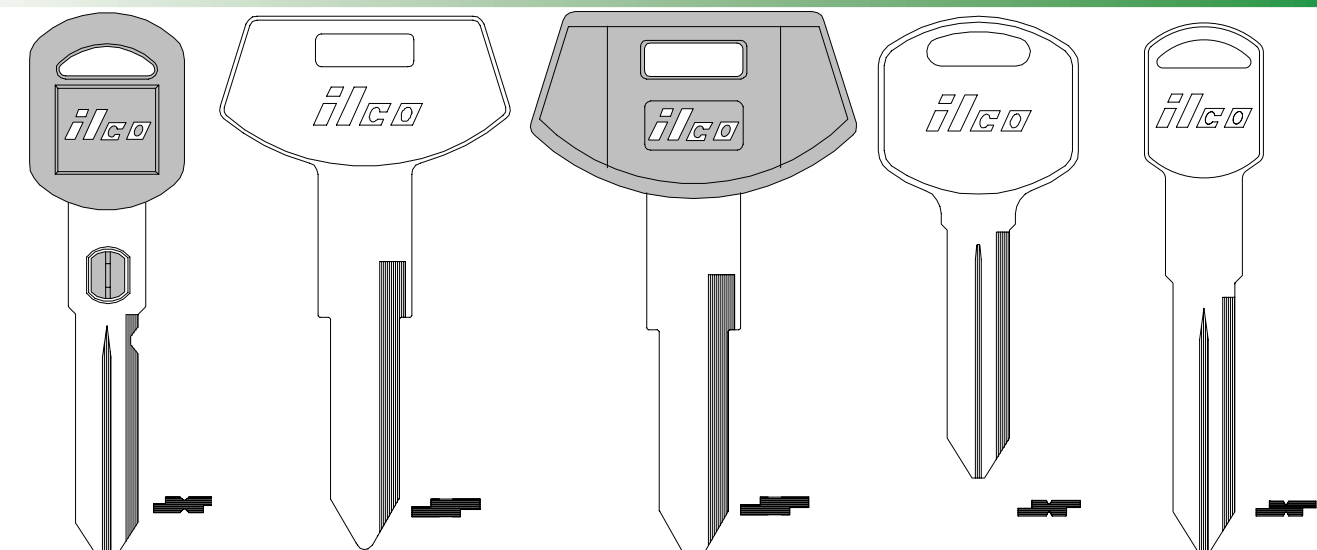

				
ILCO B82-P-2 thru 15 EZ VATS	P1101 B84	B84-P -	S1105 B85	P1106 B86





GENERAL MOTORS

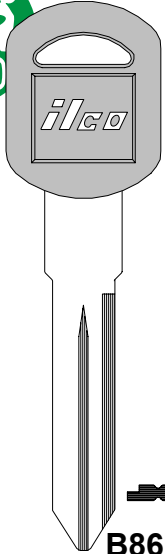

B86-P (-PC) P1107
B89

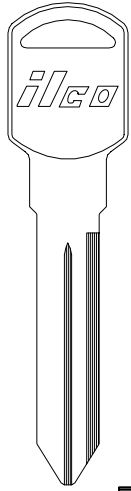

B88-P (-PC)

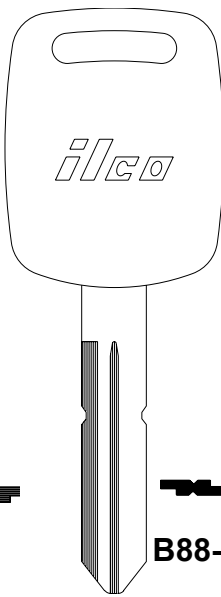

P1108
B88

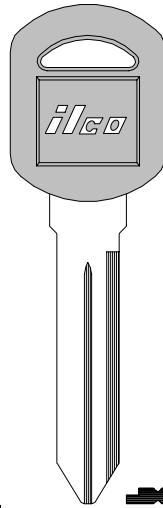

B89-P

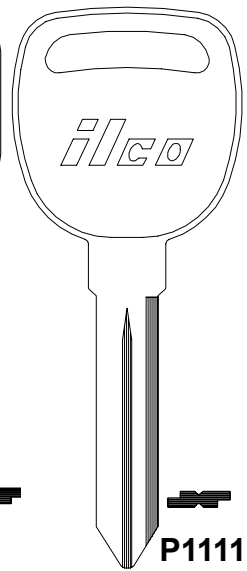

P1111 ILCO
B91 EZ

VEHICLE KEYS

GENERAL MOTORS

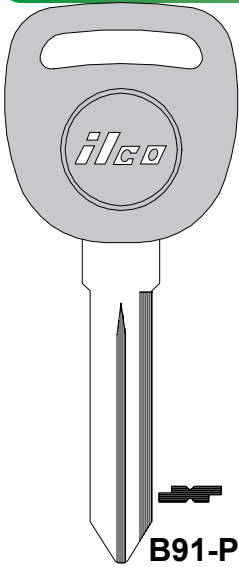

B91-P

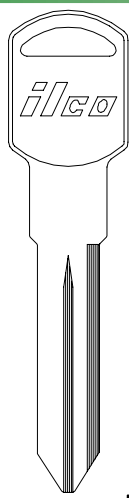

P1109
B92

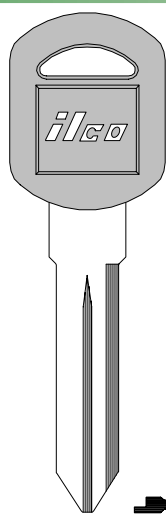

B92-P

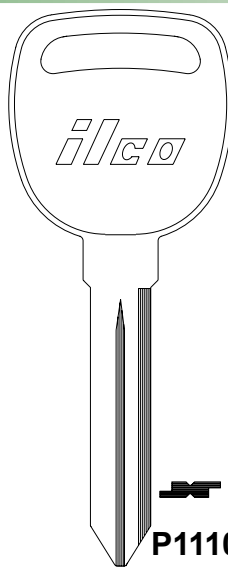

P1110
B96

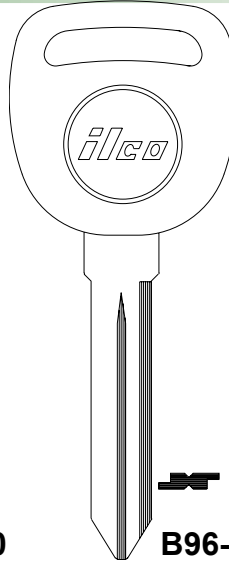

B96-P 1109V

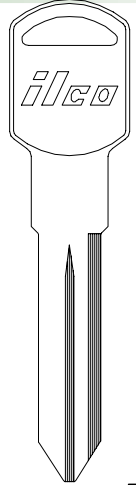

ILCO
EZ

GENERAL MOTORS

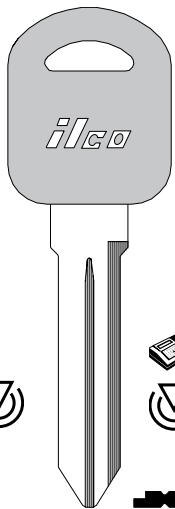

B97-PT

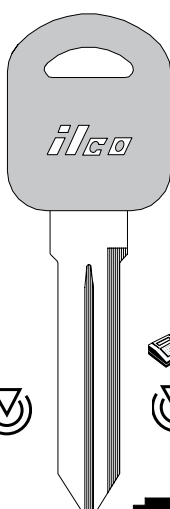

B97-PT5 B98-PT
B98-PT5

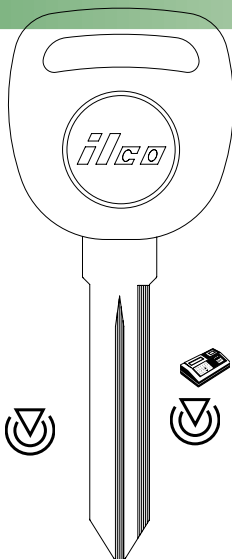

B99-PT
B99-PT5

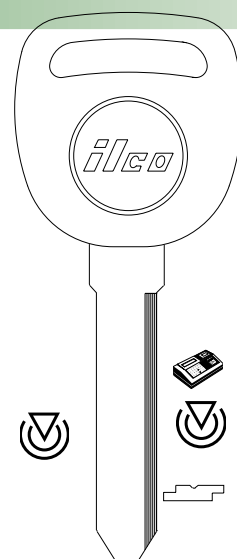

B100-PT
B100-PT5

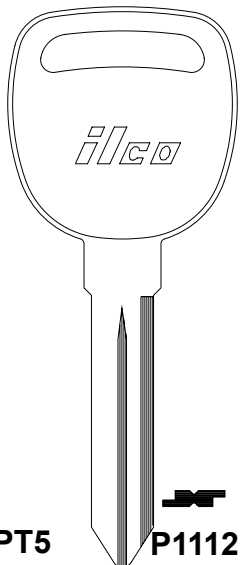

P1112 ILCO
B93 EZ

SEC 1

PG 96





GENERAL MOTORS

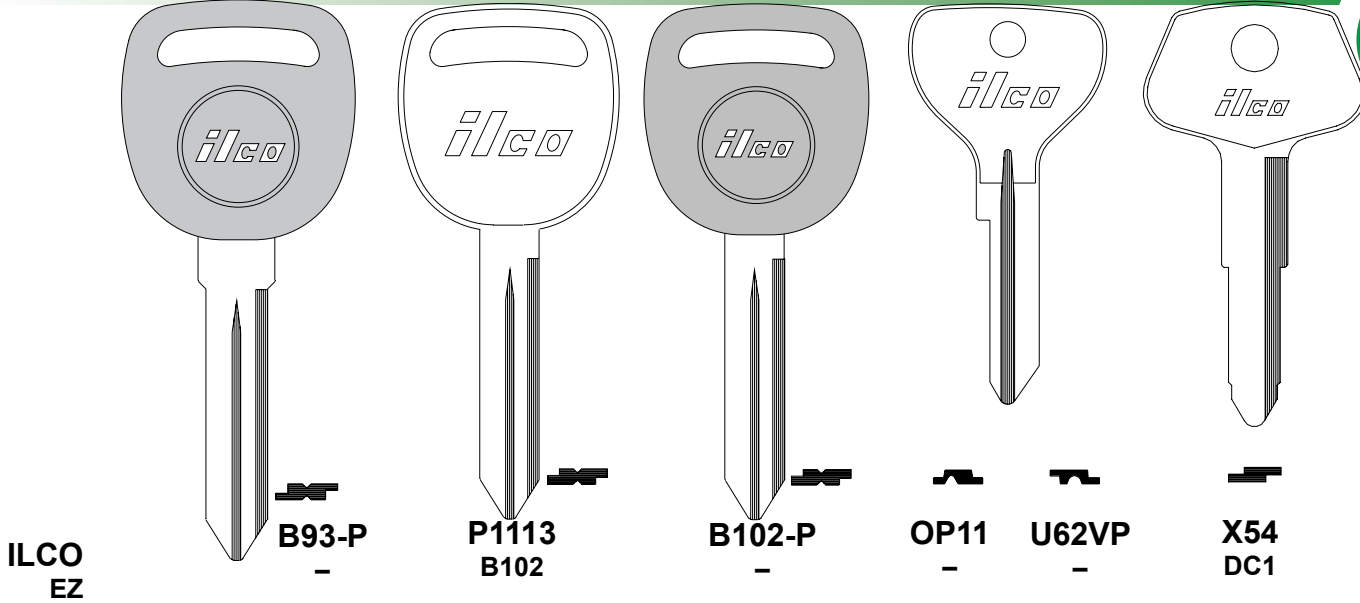

GENERAL MOTORS

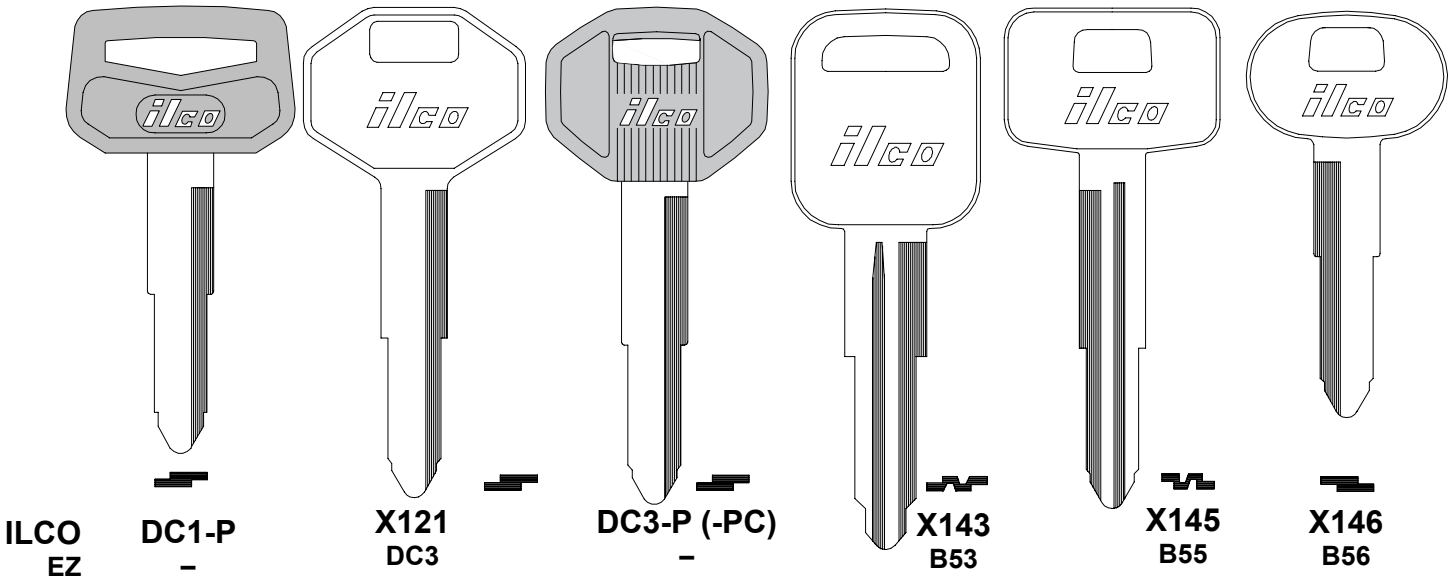

GENERAL MOTORS

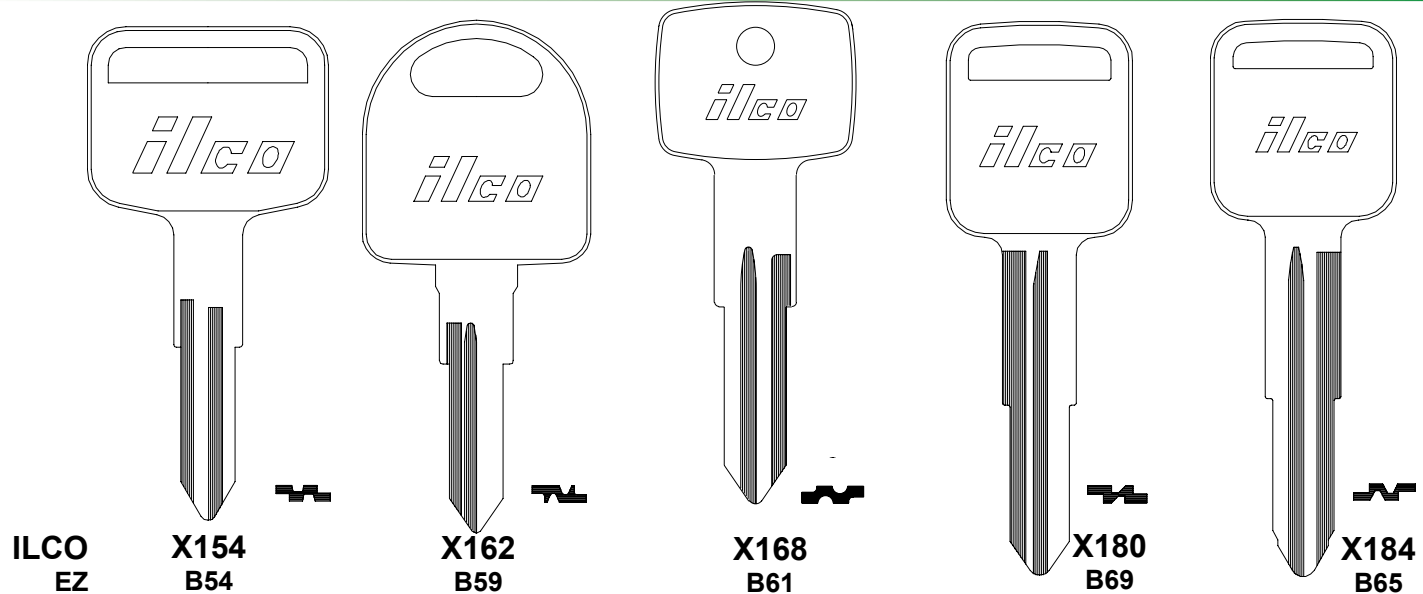

VEHICLE KEYS





GENERAL MOTORS

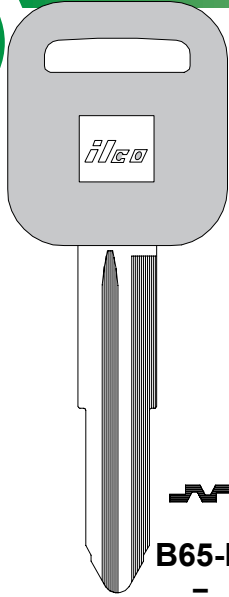

B65-P
-

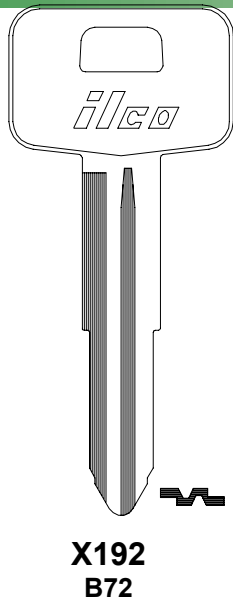

X192
B72

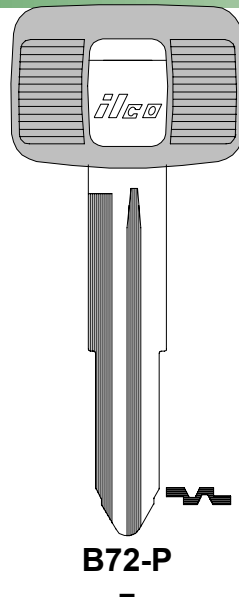

B72-P
-

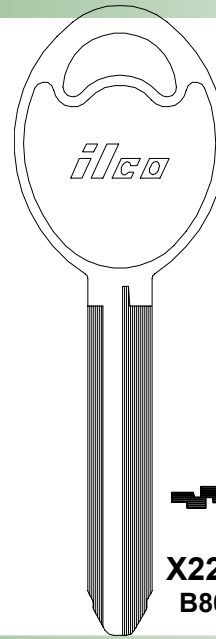

X225
B80

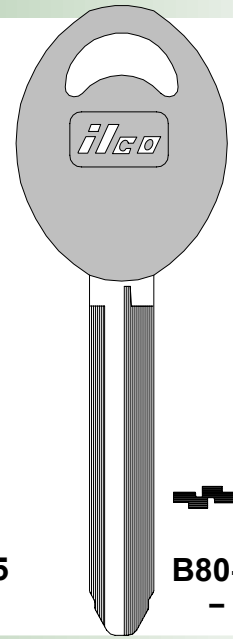

B80-PILCO
- EZ

VEHICLE KEYS

GENERAL MOTORS

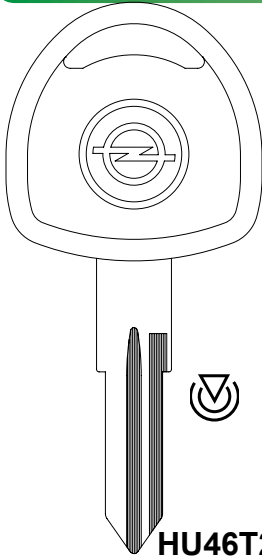

HU46T2
-

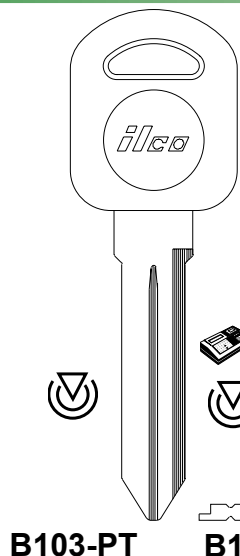

B103-PT
--

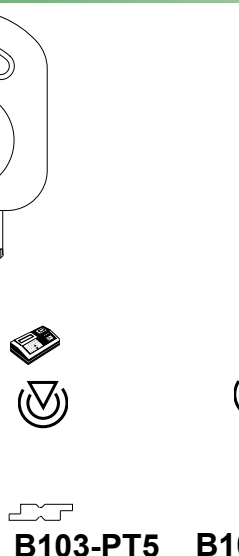

B103-PT5
-

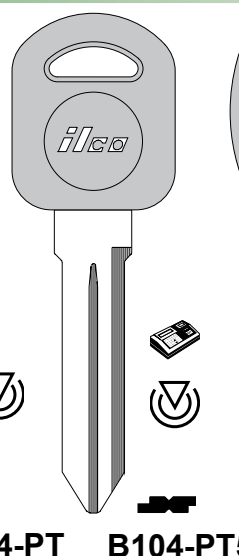

B104-PT
-

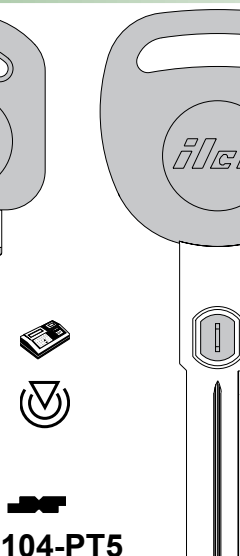

B104-PT5
-

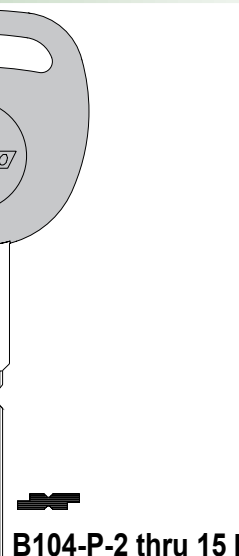

B104-P-2 thru 15 ILCO
- EZ

GENERAL MOTORS

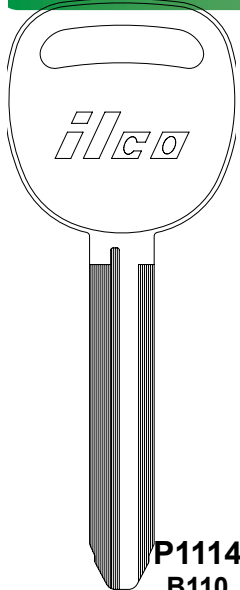

P1114
B110

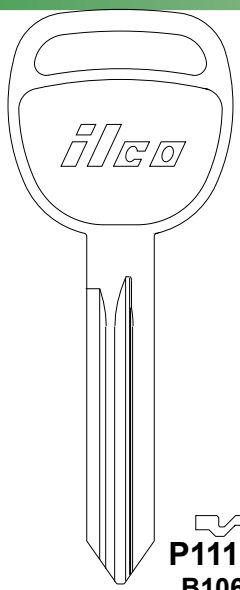

P1115
B106

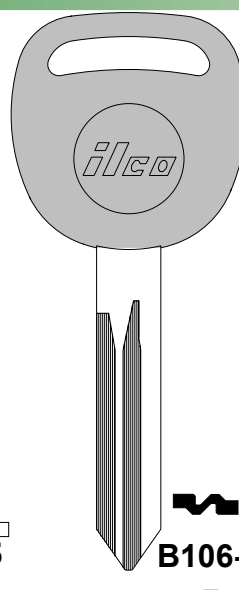

B106-P
-

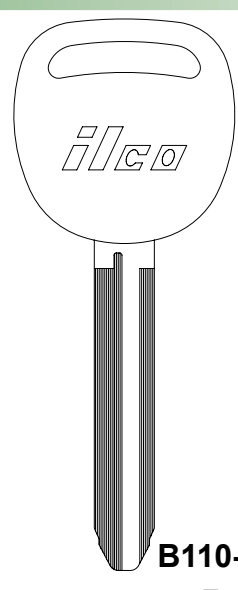

B110-P
-

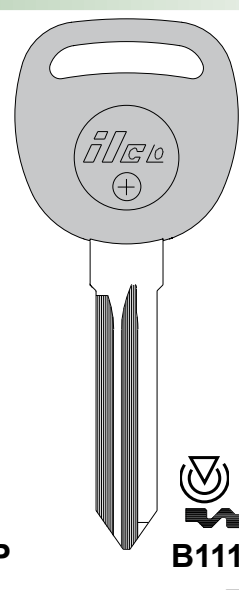

B111-PT ILCO
- EZ

GENERAL MOTORS

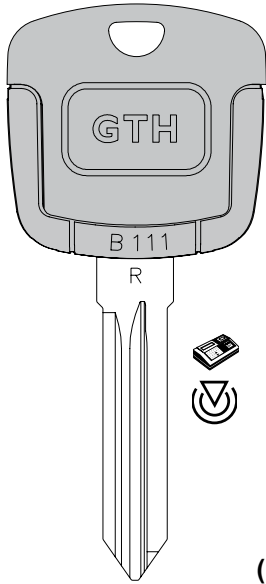

GTH
(Head Only)

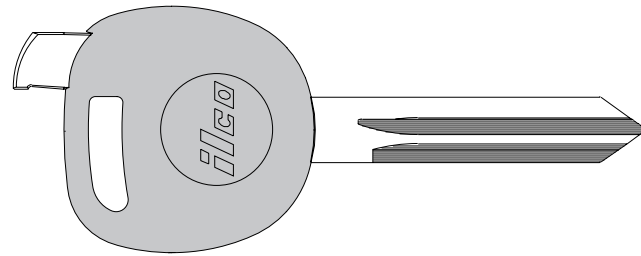

EB3-R-B111
(Blade Only)

ILCO
EZ

B111-GTK
(Complete Key)

B111-GTS
-

GENERAL MOTORS



ILCO
EZ

B111FB
-

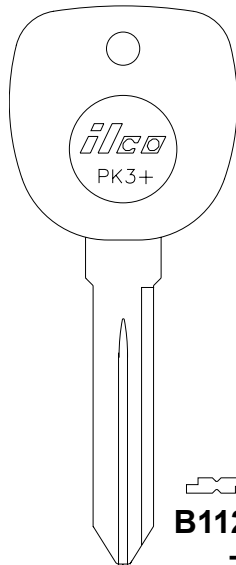

B112-PT
-

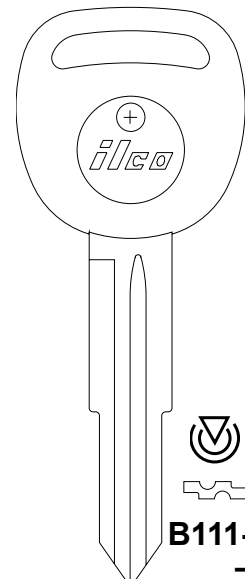

B111-GTS
-

GENERAL MOTORS

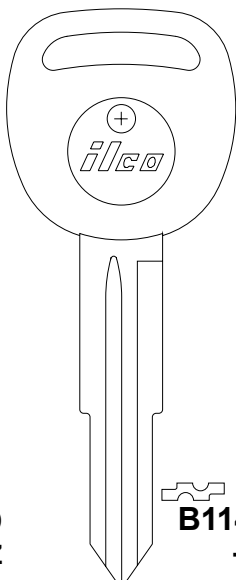

ILCO
EZ

B114-PT
-

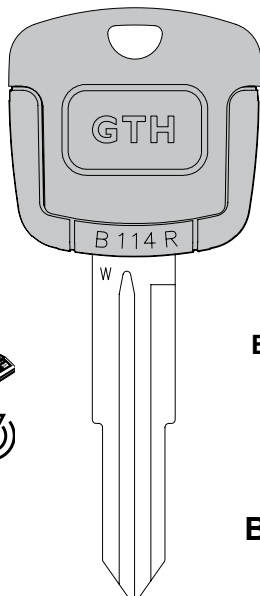

GTH
(Head Only)

EB3-W-B114R
(Blade Only)

B114R-PT
-



B116
-





GENERAL MOTORS



B117
-

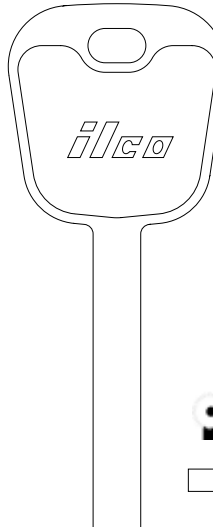

P1116
B119

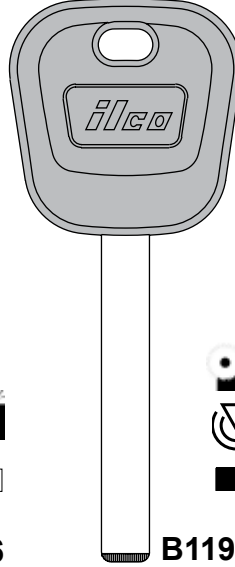

B119-PT
-

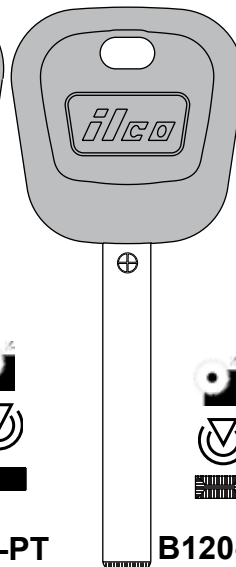

B120-PT
-



B121
-

ILCO
EZ

VEHICLE KEYS

GENERAL MOTORS



B122
-

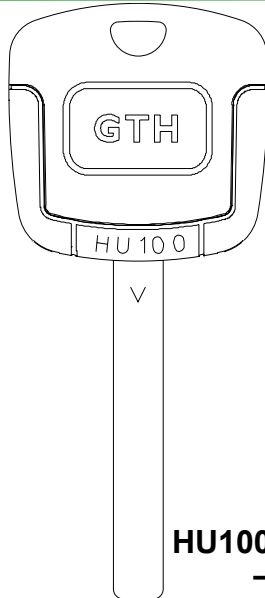

HU100-GTK
-

GTH
(Head Only)

EB3-V-HU100
(Blade Only)

ILCO
EZ

GENERAL MOTORS

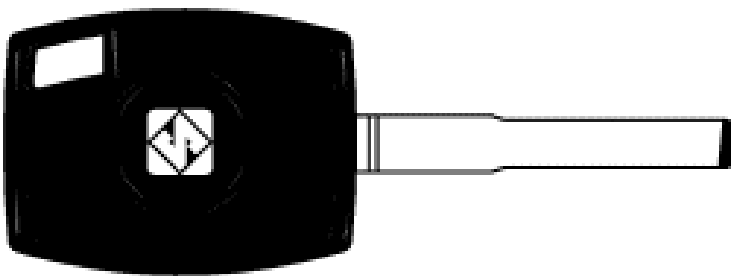

HU100-GTS
-

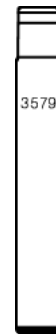

HU100FB
-

ILCO
EZ

GENERAL MOTORS

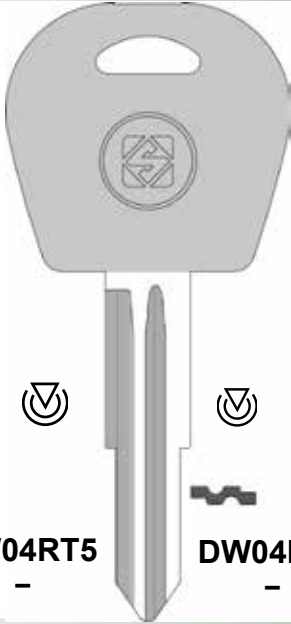

ILCO
EZ

DW04RT5
-

DW04RT6
-



DW04CT6
-

GENERAL MOTORS

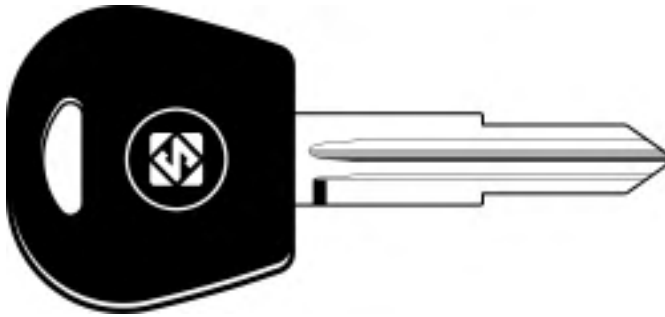

ILCO
EZ

DW04R-GTS
-

GENERAL MOTORS

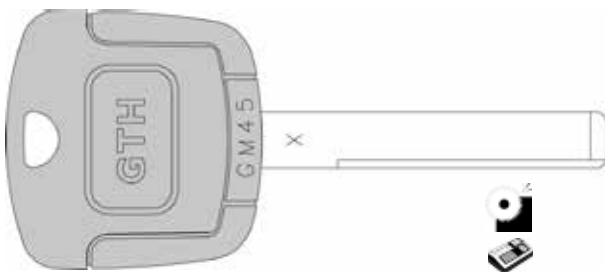

ILCO
EZ

GM45-GTK
(Complete Key)

GTH
(Head Only)



EB3-X-GM45
(Blade Only)





GENERAL MOTORS

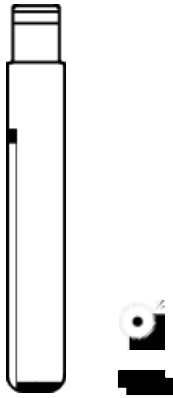

GM45-FB

-

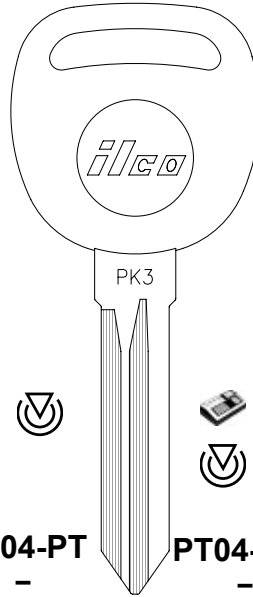

PT04-PT

-

PT04-PT5

-

ILCO
EZ

VEHICLE KEYS

GENERAL MOTORS

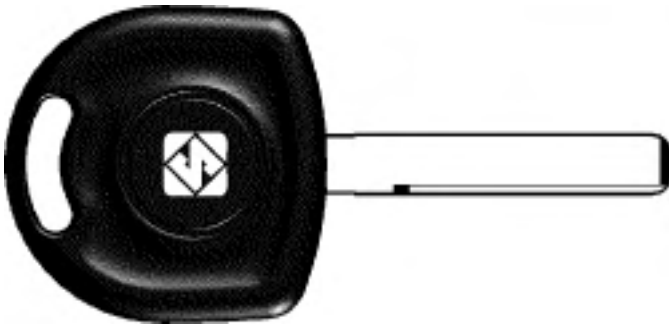

GM45-GTS

-



GTH
(Head Only)

EB3-E-TOY43
(Blade Only)

TOY43-GTK
(Complete Key)

ILCO
EZ

GENERAL MOTORS

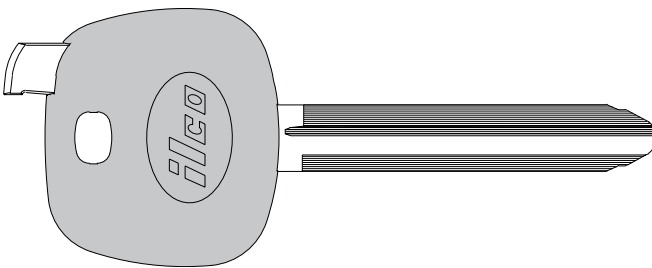

TOY43-GTS

-

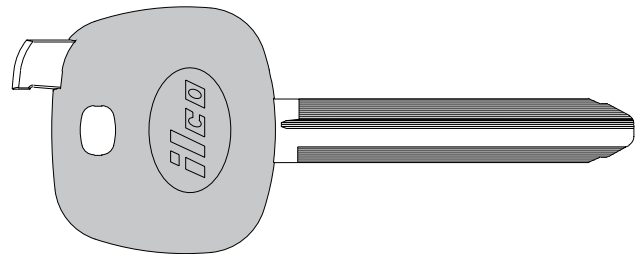

TOY43R-GTS

-

ILCO
EZ

GENERAL MOTORS

GENERAL MOTORS INTERNATIONAL

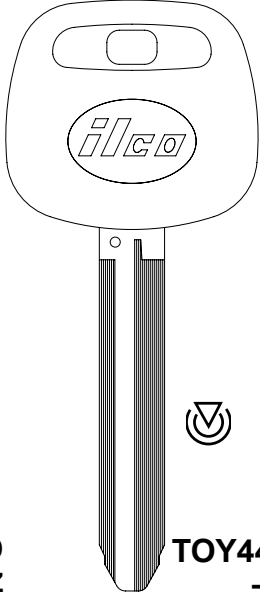

ILCO EZ TOY44D-PT -

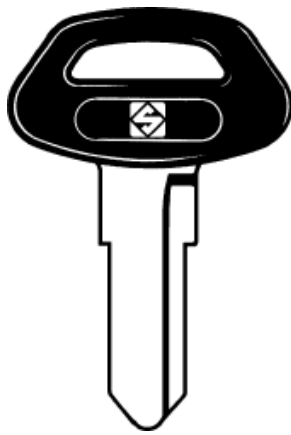

SZ4AP-SI -

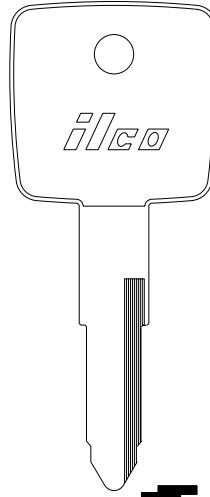

SZ5 -

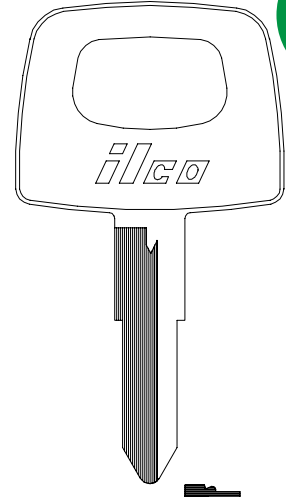

P1098V LUV1 -

GILERA

GOLF CART



ILCO EZ ZD17RAP-SI -



ZD24RDP-SI -

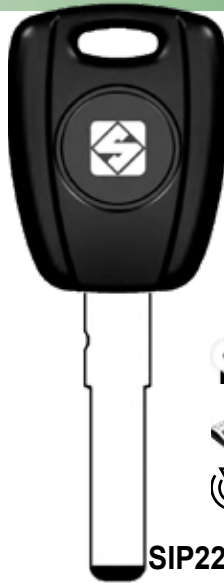

SIP22T5-SI -

HY98 -

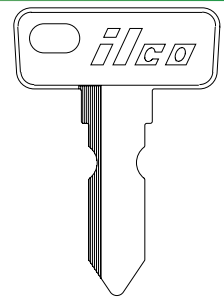

L62VA -

VEHICLE KEYS

GOLF CART

GRUMMAN LONG LIFE VEHICLE (PO)

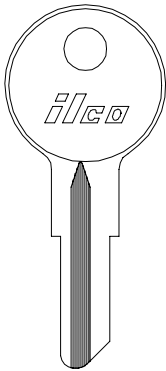

ILCO EZ CC1 -

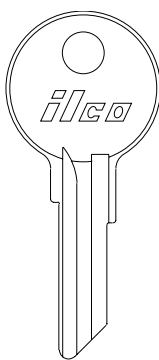

CC2 -

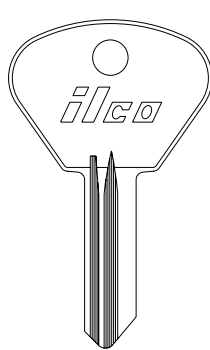

1098L B3 -

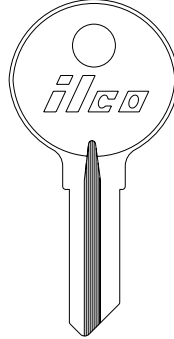

F91G -

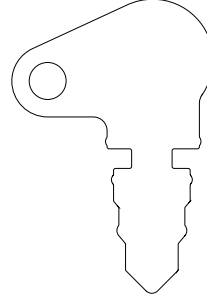

1069B -

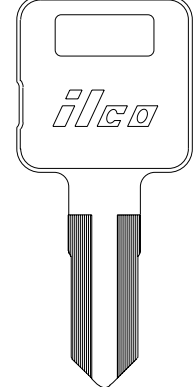

1524 -





HARLEY DAVIDSON

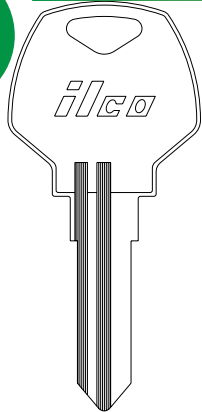

HYD2
-

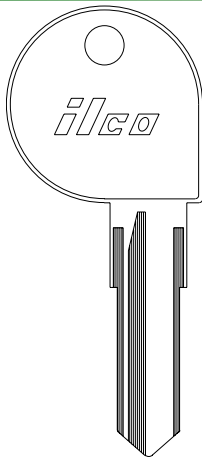

HYD7
-

HYD11
-

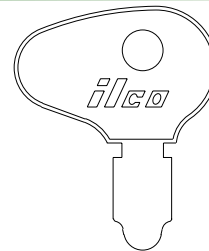

X70
-

HYD1
-

HYD5
-

HYD6
-

HYD10
-

ILCO
EZ

HARLEY DAVIDSON

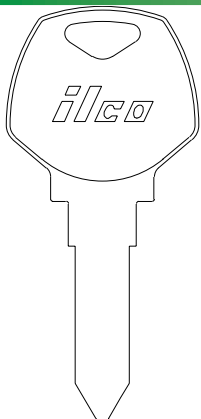

X94
-

X98
-

X125
-

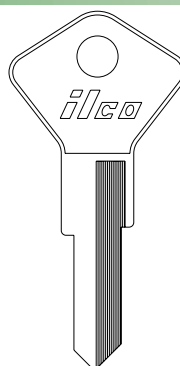

H72G
-

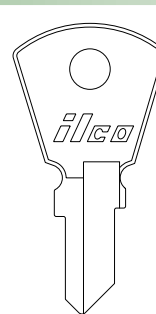

H72H
-

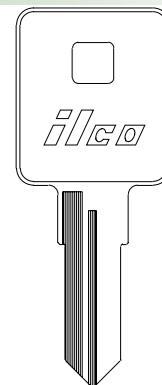

X234
HYD13

ILCO
EZ

X95
-

X100
-

X126
-

X96
-

X101
-

X127
-

X93
-

X97
-

X102
-

H78KR
-

HARLEY DAVIDSON

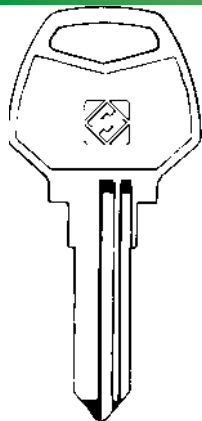

HY6R
-

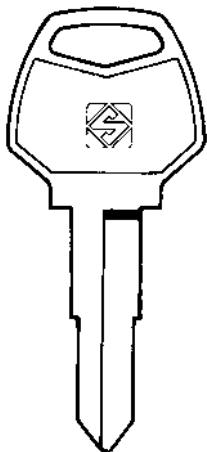

HY9
-

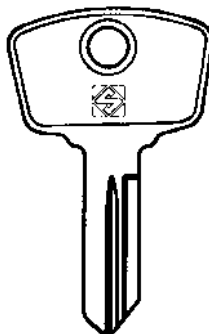

ISP2
-

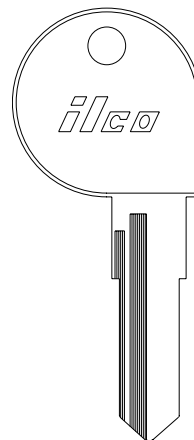

X133
HN3

X134
-

X142
-

X135
-

X136
-

X141
-

ILCO
EZ

VEHICLE KEYS



HARLEY DAVIDSON



VEHICLE KEYS

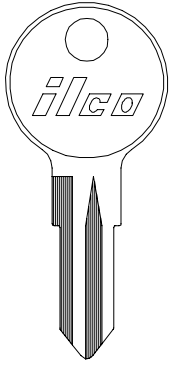

ILCO
EZ X226
HYD12

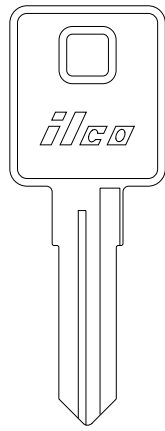

X287
HYD15

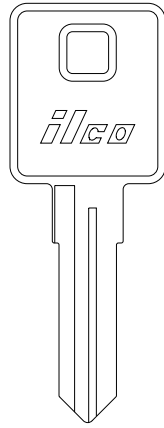

X283
HYD16

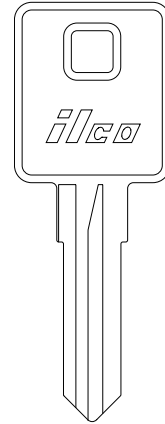

X284
HYD17

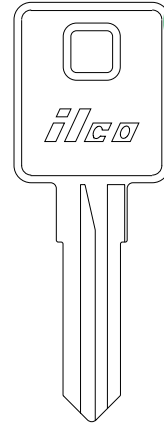

X285
HYD18

HARLEY DAVIDSON

HEINKEL

HINO

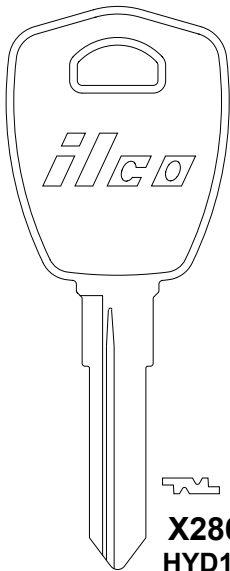

ILCO
EZ X286
HYD19

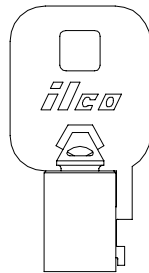

OD .377" - 0.6mm
ID .312" - 7.9MM
(BRASS)

1137B
-

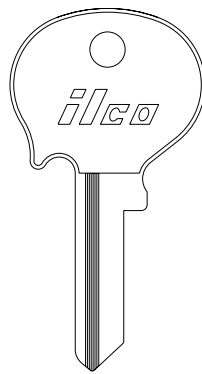

NE5
-

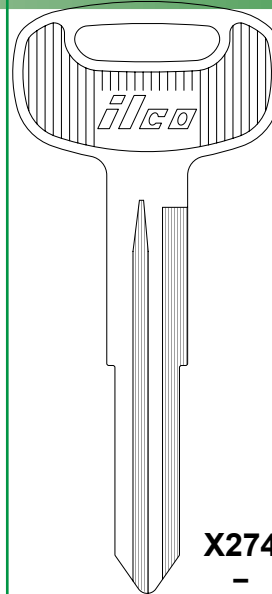

X274
-

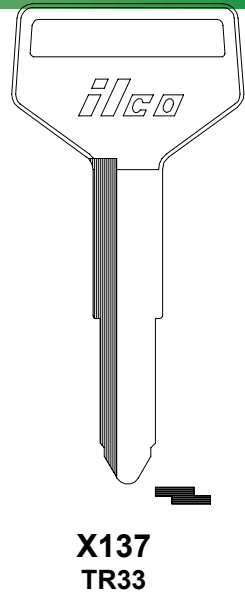

X137
TR33

HINO

HODAKA

HONDA (AUTOMOBILES)

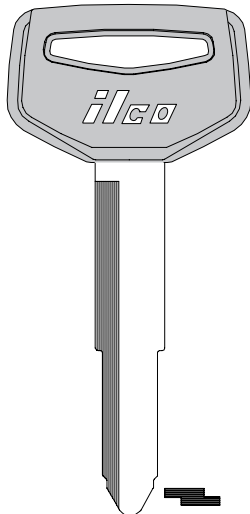

ILCO
EZ TR33-P (-PC)
-

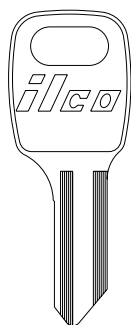

HOD1
-

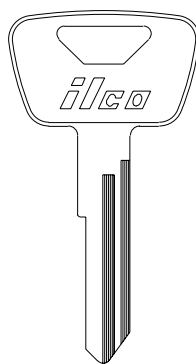

HD23
-

HD29
-

HD30
-

HD31
-

HD32
-

HD33
-

HD35
-

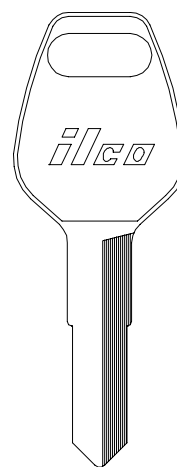

X38
HO41

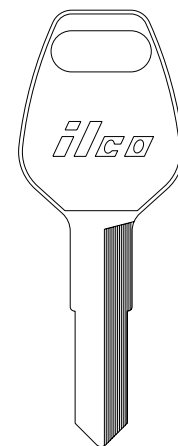

X44
HO44





HONDA (AUTOMOBILES)

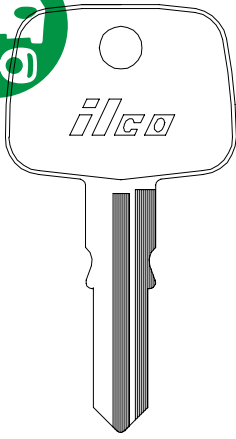

X38
HO41

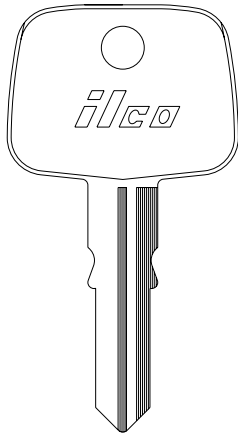

X44
HO44

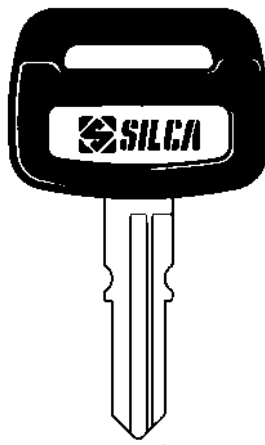

X51
AA2

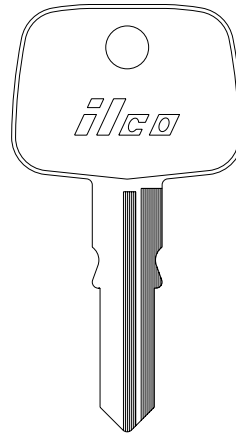

HD70
-

ILCO
EZ

VEHICLE KEYS

HONDA (AUTOMOBILES)

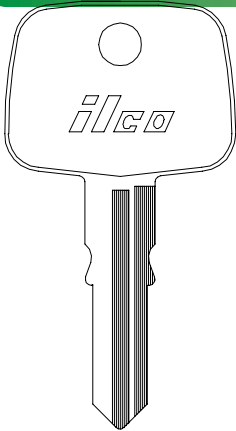

X71
HD70U

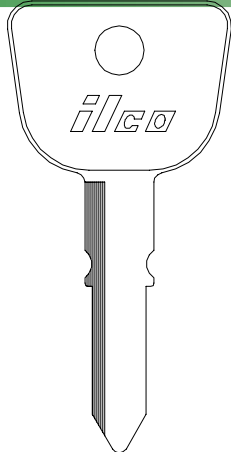

X129
HD82

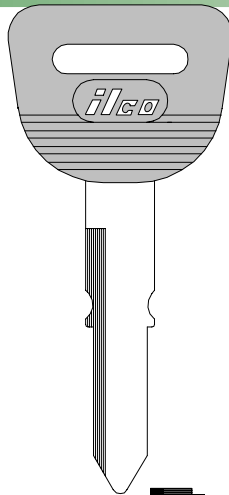

HD82-P
-

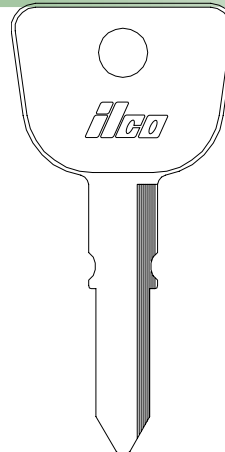

X130
-

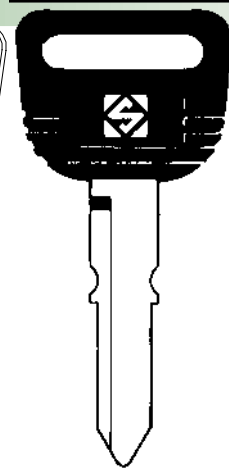

HON38RP
-

ILCO
EZ

HONDA (AUTOMOBILES)

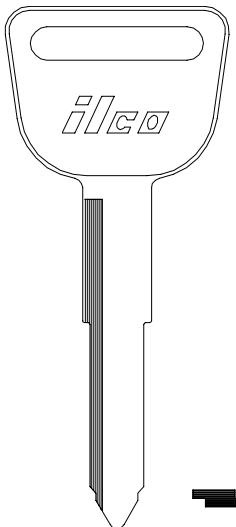

X181
HD90

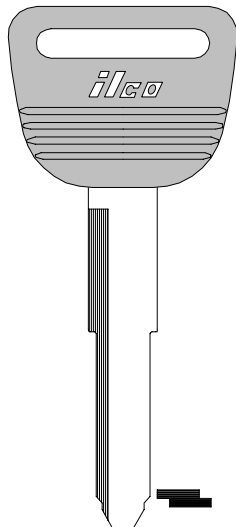

HD90-P (-PC)
-

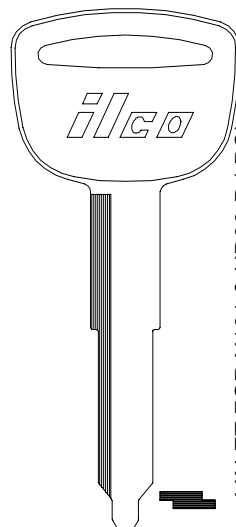

X190
HD94

VALET FOR X181 & HD90-P (-PC)

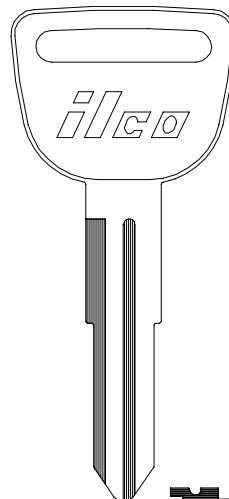

X182
HD91

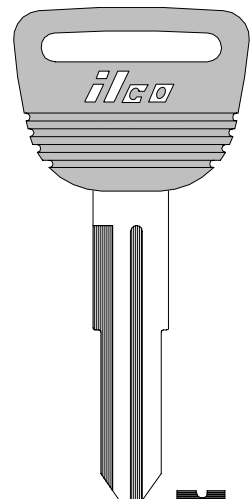

HD91-P
-

ILCO
EZ



HONDA (AUTOMOBILES)

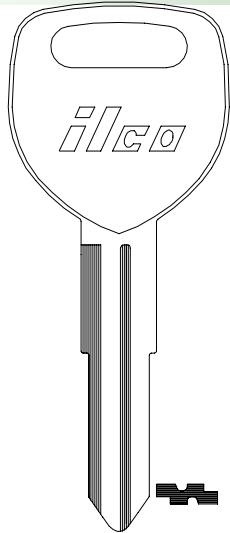

ILCO EZ X71 HD70U

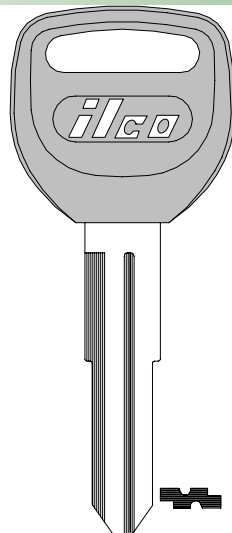

X129 HD82

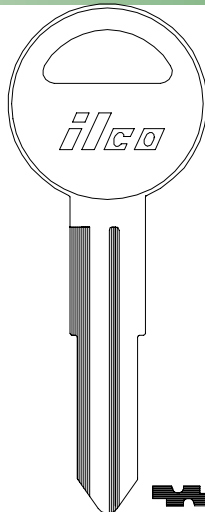

HD82-P -

VALET FOR X182, HD90-P (-PC), X195 & HD98-P (-PC)

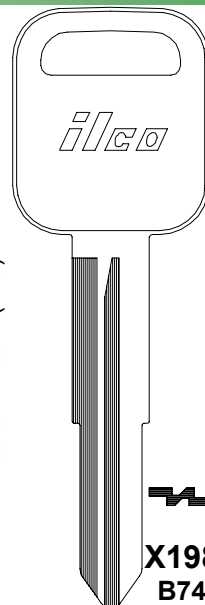

X198 B74

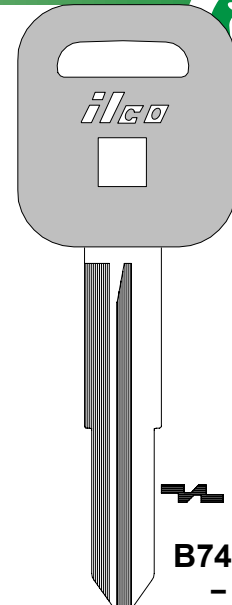

B74-P -

HONDA (AUTOMOBILES)

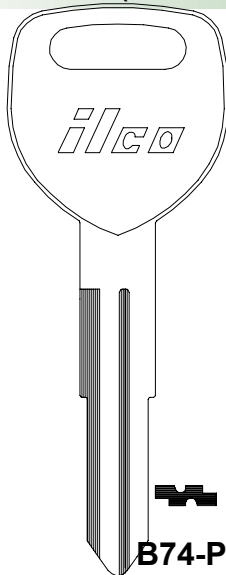

ILCO EZ B74-P -

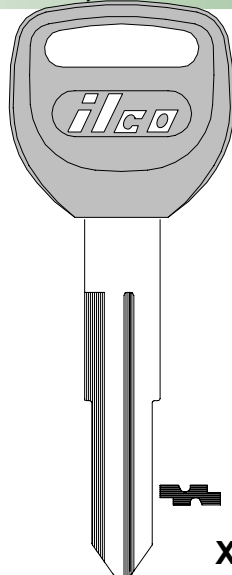

X214 HD103

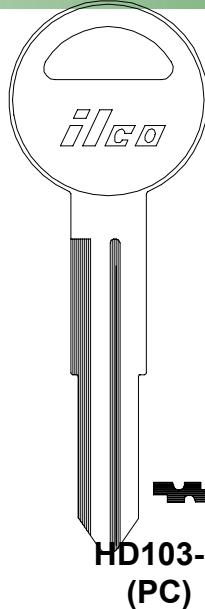

HD103-P (PC)

VALET FOR X214 & HD103-P (-PC)

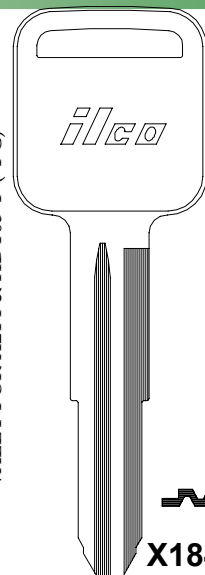

X184 B65

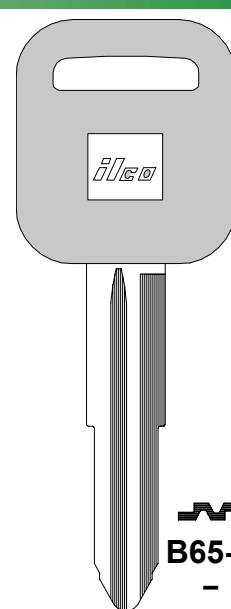

B65-P -

HONDA (AUTOMOBILES)

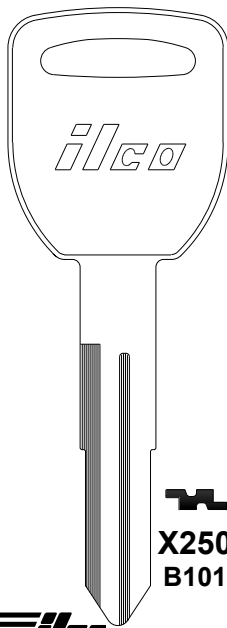

ILCO EZ X250 B101

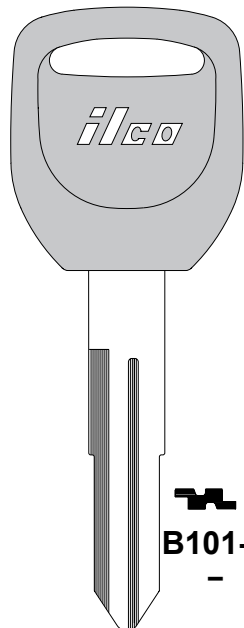

B101-P -

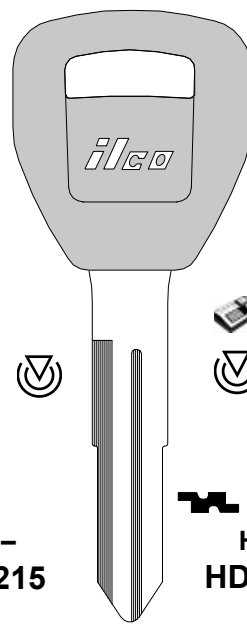

- X215



HD104 HD106-PT





HONDA (AUTOMOBILES)

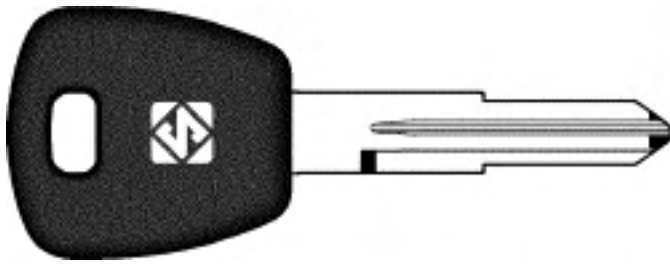

B74-P
-



X214
HD103

ILCO
EZ

VEHICLE KEYS

HONDA (AUTOMOBILES)

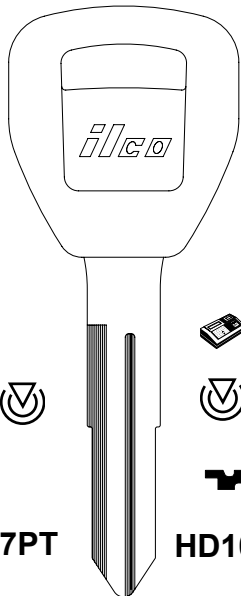

HD107PT
-



HD107-PT5
-

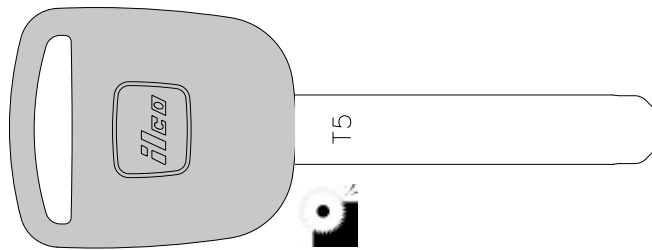

H001-PT
-



HO01T5
-

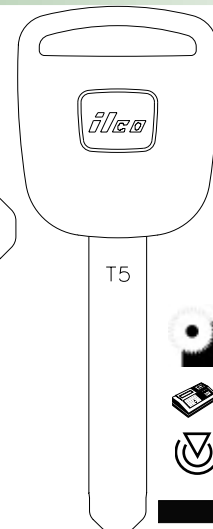

HOV01T5
-



VALET FOR HO01T5

ILCO
EZ

HONDA (AUTOMOBILES)

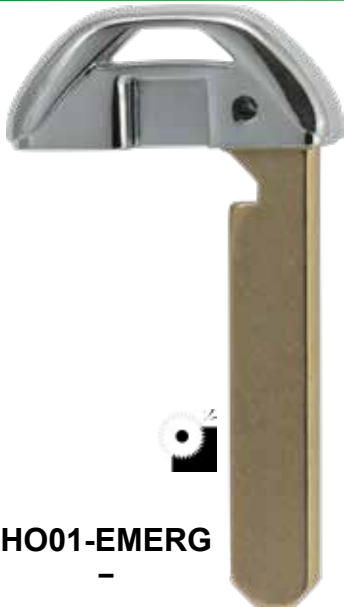

HO01-EMERG
-

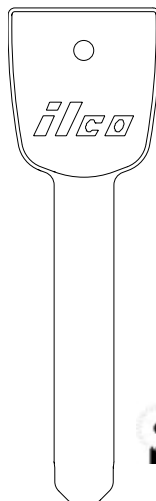

HO01-SCV
-



HO01FB
-



HO03FB
-



ILCO
EZ

SEC 1

PG 108



HONDA (AUTOMOBILES)

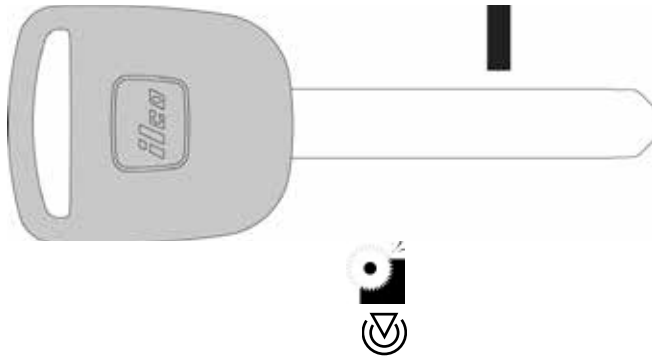

ILCO
EZ

HD107PT
-

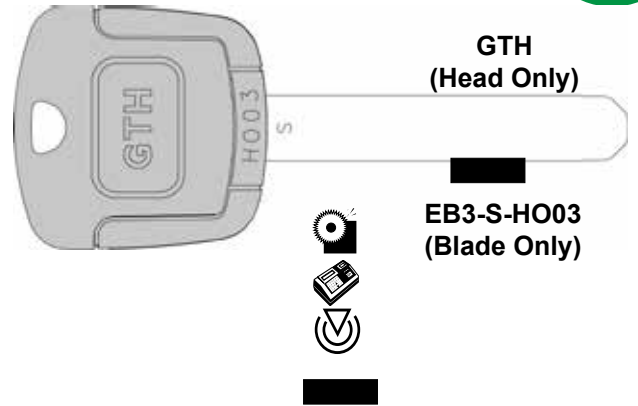

HO03-GTK
(Complete Key)

GTH
(Head Only)

EB3-S-HO03
(Blade Only)

HONDA (AUTOMOBILES)

VEHICLE KEYS

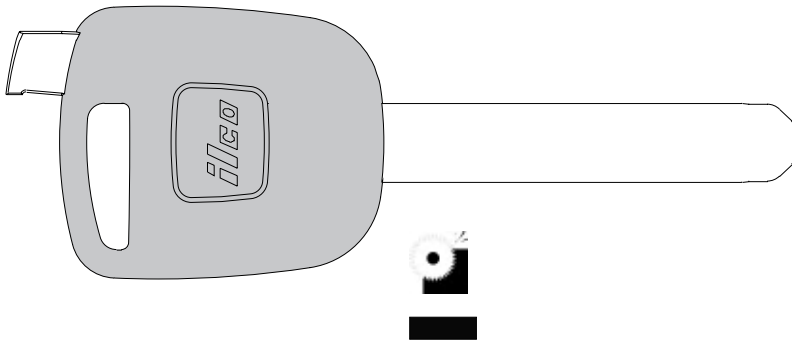

ILCO
EZ

HO03-GTS
-

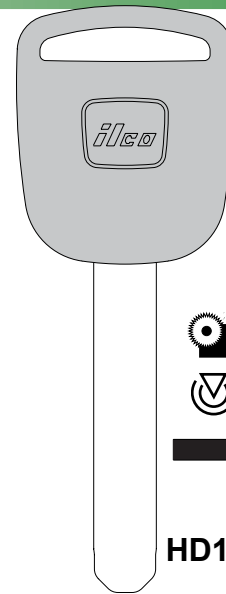

HD113-PT
-

HONDA (AUTOMOBILES)

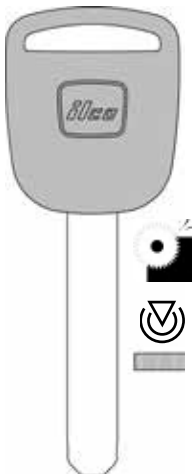

ILCO
EZ

HO05-PT
-

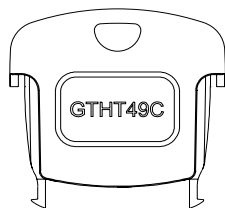

GTHT49C
-



HO03-
GTS



HD113-PT





HONDA (MOTORCYCLES)

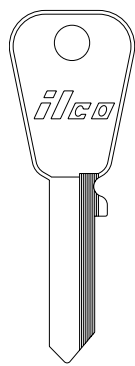

HD2
-

HD3
-

HD22
-

HO03-GTS
-

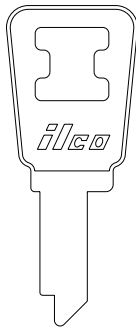

HD9
-

HD17
-

HD19
-

HD113-PT HON-3B
-

HD20
-

HD21
-

HD28
-

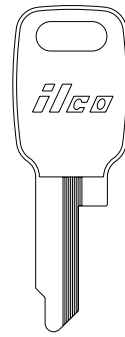

HD26
-

HON-4BHD5R

ILCO
EZ

VEHICLE KEYS

HONDA (MOTORCYCLES)

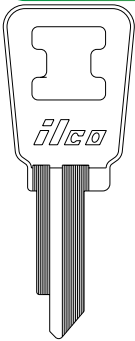

HD16
-

E67K
-

HD6
-

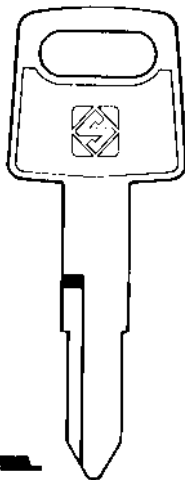

HON24
-

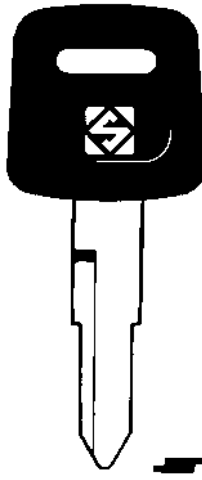

HON24RP
-

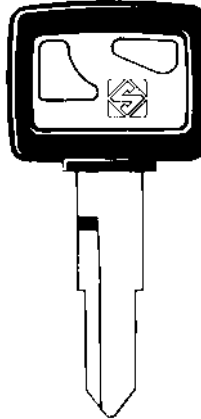

HON39P
-

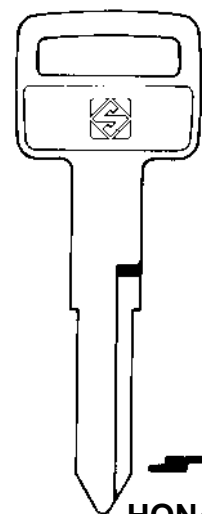

HON42
-

ILCO
EZ

HONDA (MOTORCYCLES)

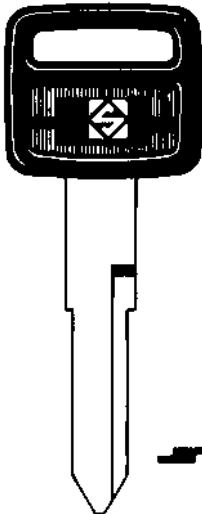

HON42AP
-

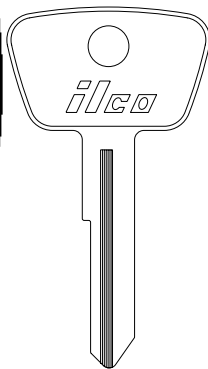

HD7
-

HD23
-

HD29
-

HD30
-

HD31
-

HD32
-

HD33
-

HD34
-

HD35
-

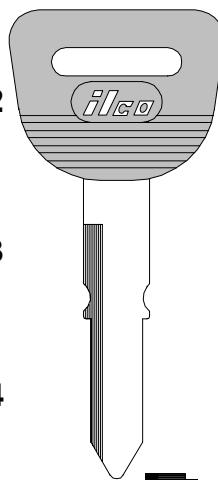

HD82-P
-

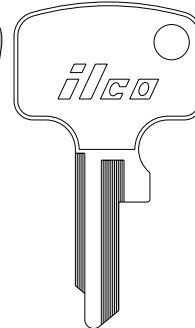

HD10
-

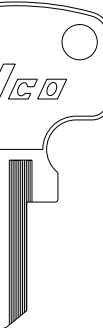

HD11
-

HD12
-

HD13
-

HD14
-

HD15
-

HD42
-

HD43
-











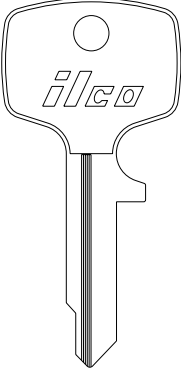

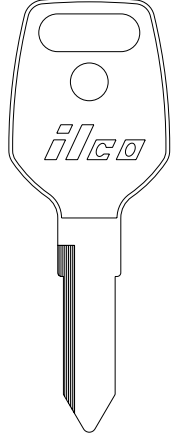

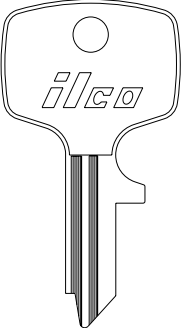



H76G
-

H76X
-









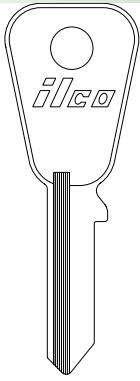

ILCO
EZ

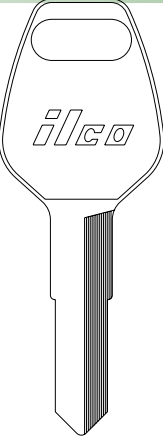
HONDA (MOTORCYCLES)

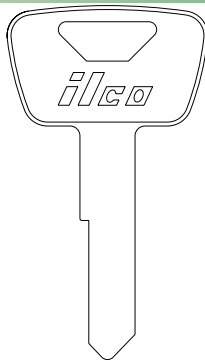

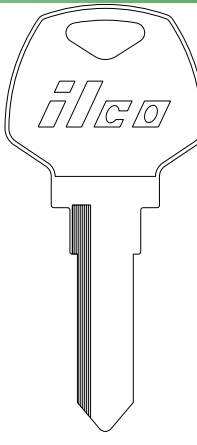

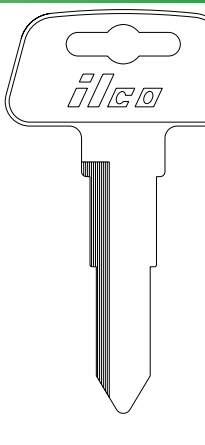





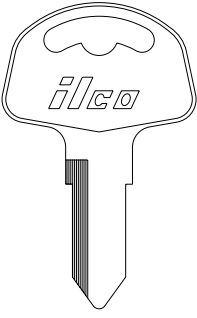

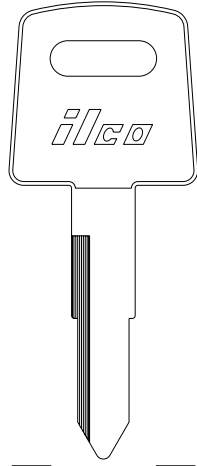

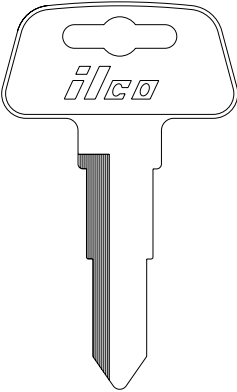
									
<i>ilco</i>	HO61Q	<i>ilco</i>			<i>ilco</i>		<i>ilco</i>	HD37	
	-							-	
									
	67J							HD38	
	-							-	
									
	R67K							HD39	
	-							-	
	ILCO EZ		HD6		HON24		HON24RP		HD25
	-		-		-		-		-
			HD36		HD46				
		-	-		-				

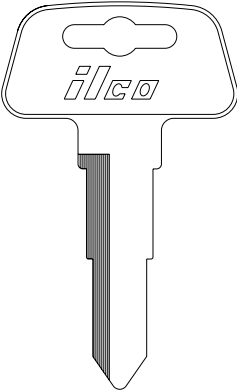
HONDA (MOTORCYCLES)

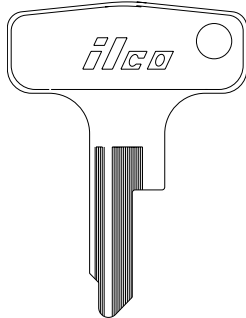
									
<i>ilco</i>	X42	<i>ilco</i>	X43	<i>ilco</i>	X44	<i>ilco</i>	HD45	<i>ilco</i>	HD49
	HD47		HD48		HO44		-		-
ILCO EZ	X42	X43	X44	HD45	HD49	HD51	HD53		
	HD47	HD48	HO44	-	-	-	-		

HONDA (MOTORCYCLES)

									
<i>ilco</i>	HD56	<i>ilco</i>	HD57	<i>ilco</i>	X57	<i>ilco</i>	X58	<i>ilco</i>	HD58
	-		-		HD72		HD73		-
ILCO EZ	HD56	HD57	X57	X58	HD58	HD59			
	-	-	HD72	HD73	-	-			
									HD60
									-
									HD61
									-

VEHICLE KEYS





HONDA (MOTORCYCLES)

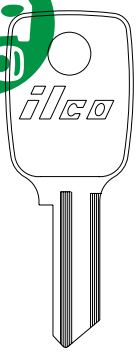

X42
HD47

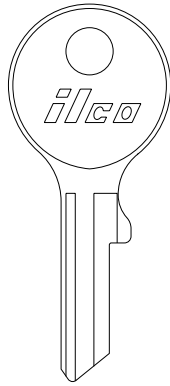

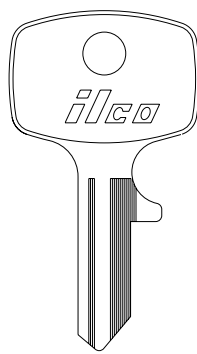

X43
HD48





X44
HO44

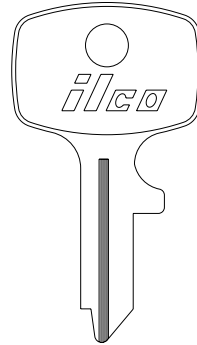

HO61H
-

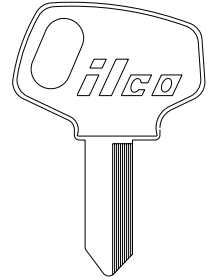

HO61R
-





HD62
-

ILCO
EZ

VEHICLE KEYS

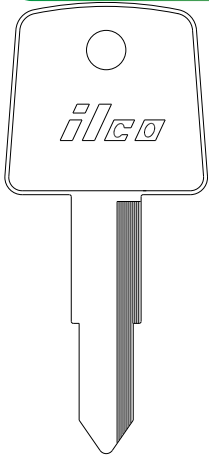
HONDA (MOTORCYCLES)



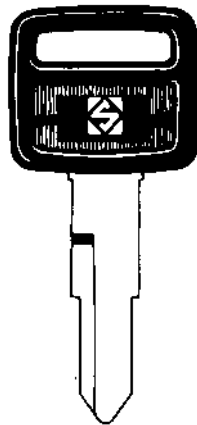

HD63
-



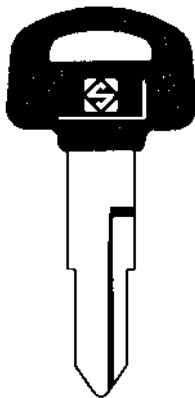

HON31RAP
-

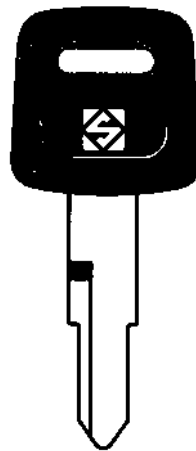

HON31RBP
-



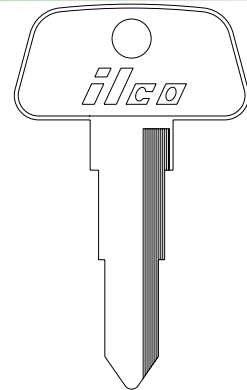

HON31RP
-



HD64
-

ILCO
EZ

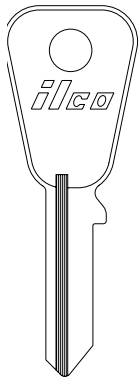
HONDA (MOTORCYCLES)





HD65
-

HD66
-

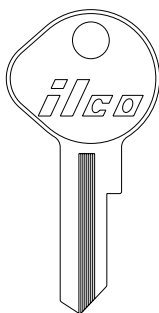

HD68
-

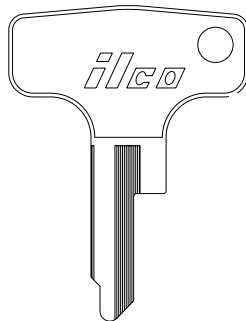



67H
-



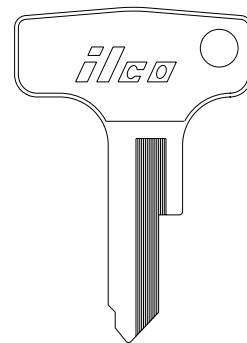

67LD
-

67LB
-

67LC
-



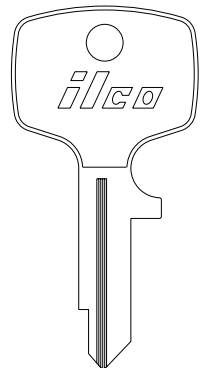

B67K
-



C67K
-

ILCO
EZ

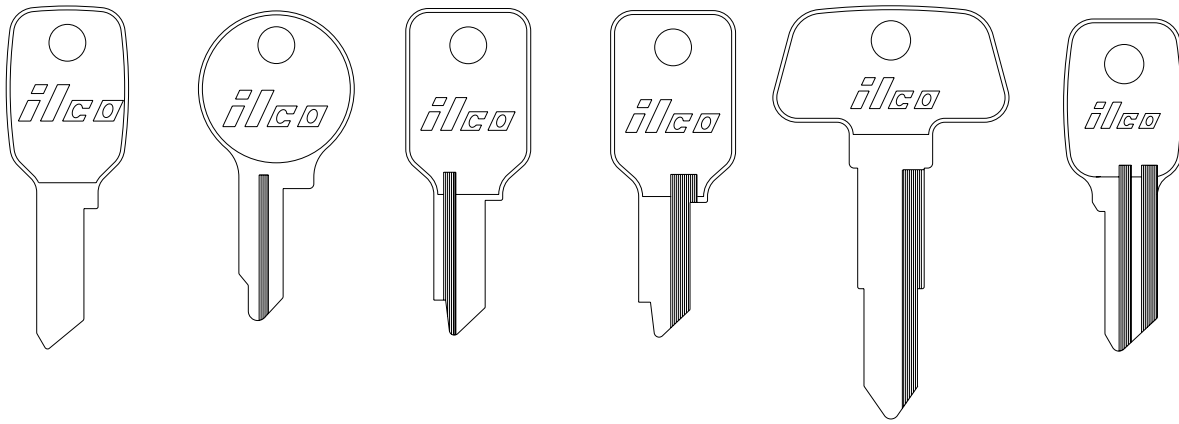
HONDA (MOTORCYCLES)



H70XR

-

H70Z

-

ILCO EZ HD63 HON31RAP HON31RBP U67KR HD69 H70X

VEHICLE KEYS

HONDA (MOTORCYCLES)

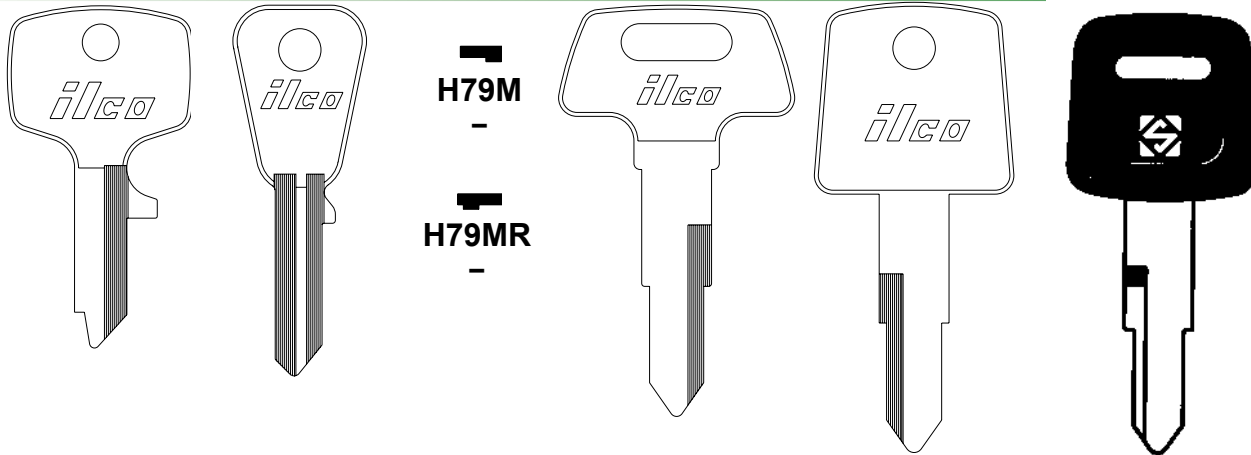

H79M

-

H79MR

-

ILCO EZ H73Z H77P H77PR X84 HD74 X138 HD75 HON31P

HONDA (MOTORCYCLES)

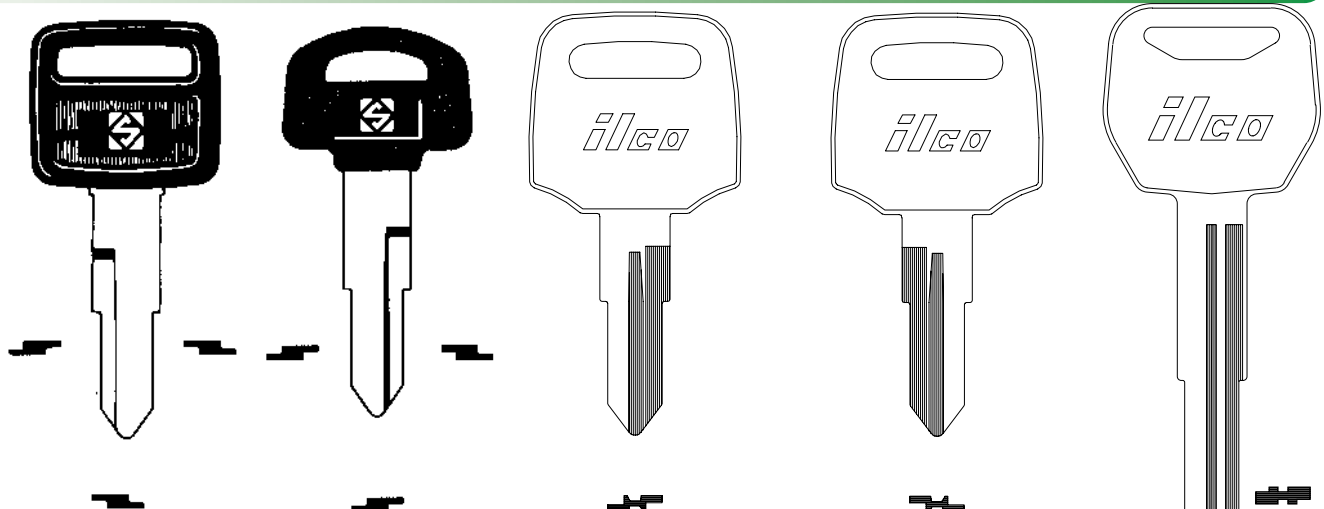

ILCO EZ HON31AP HON31BP X246 HD105 X252 HD108 X265 HD109

SEC 1 PG 113





HONDA (MOTORCYCLES)

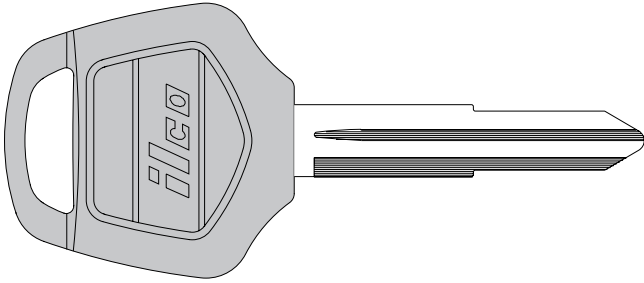

H73Z
-

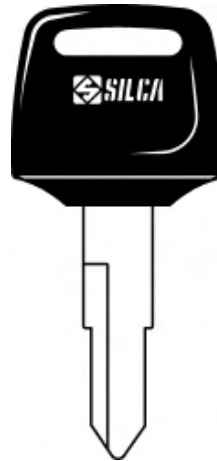

HON31CP-SI
-

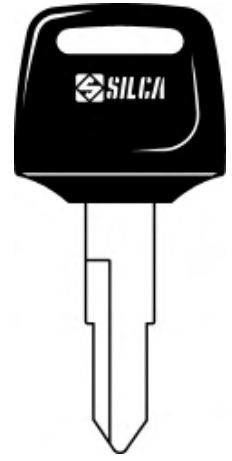

HON31RCP-SI ILCO
EZ

VEHICLE KEYS

HONDA (MOTORCYCLES)

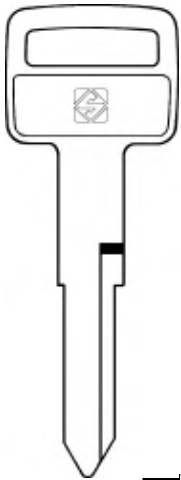

HON41-SI
-

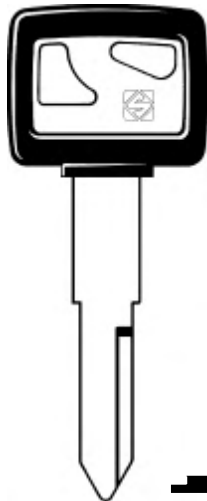

HON41P-SI
-

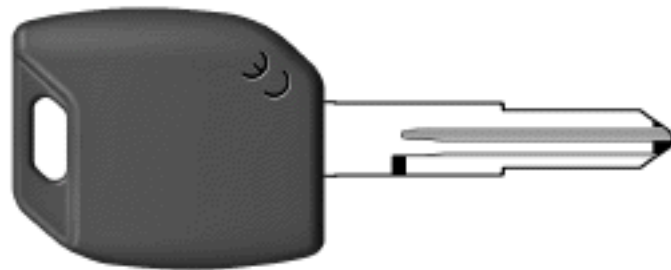

HON58RMH
-

ILCO
EZ

HONDA (MOTORCYCLES)



HON58RTE-GTS/HD106-GTS
-

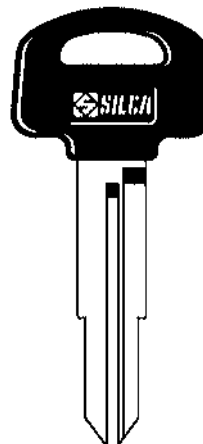

HON64BP-SI HON64RBP-SI
-

ILCO
EZ

HONDA (MOTORCYCLES)

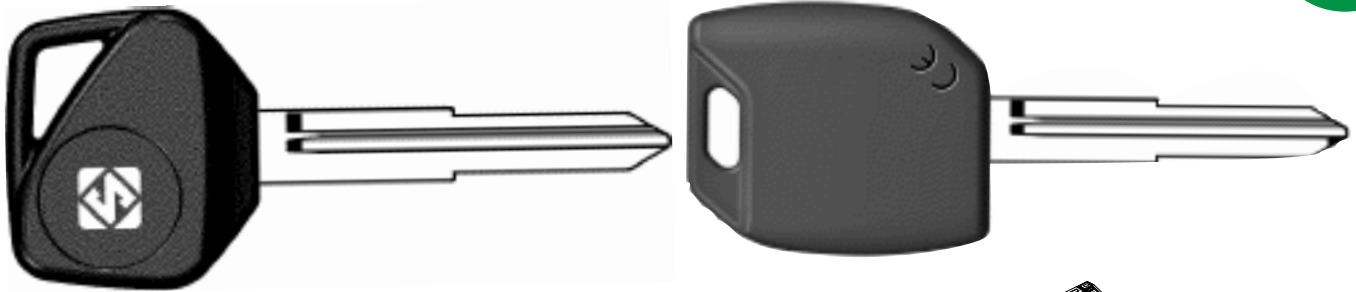

ILCO
EZ

HON70T14-SI

-

HON70MH

-

HONDA (MOTORCYCLES)

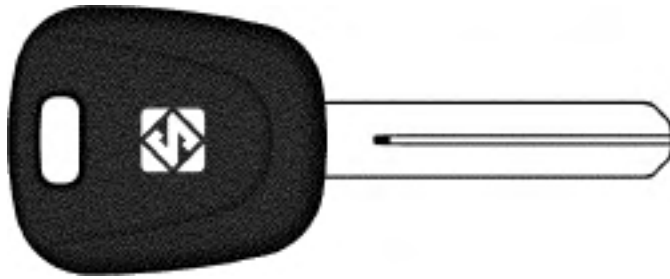

HON77TE-GTS

-

ILCO
EZ



ZD24RDP-SI

-

ZD24RT14-SI

-

HONDA (MOTORCYCLES)

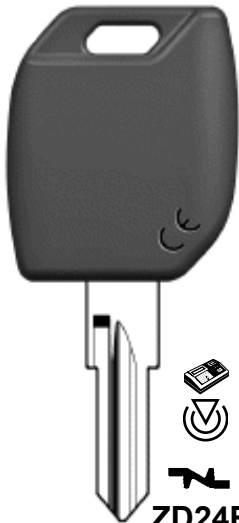

ZD24RMH

-

ILCO
EZ





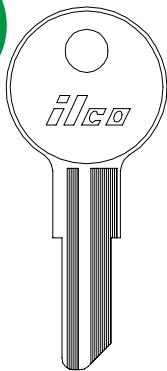

HUDSON

HURD



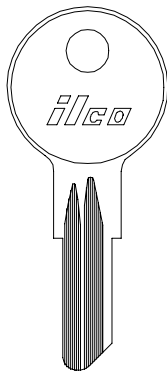

1041T
CG16



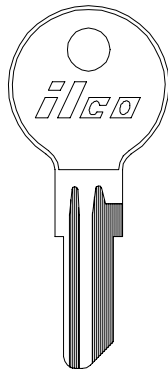

1098DB
B5

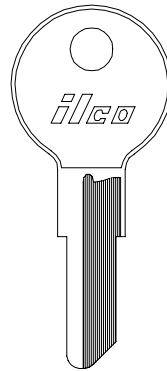

HON77TE-GTS
-

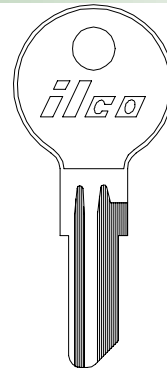

O1122A
Y12





O1122A
Y12

ILCO
EZ

VEHICLE KEYS

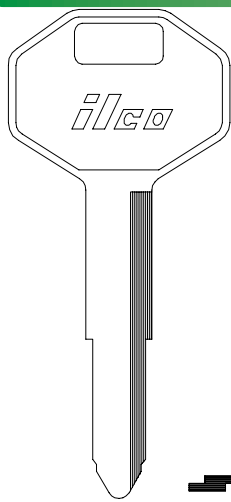
HYUNDAI



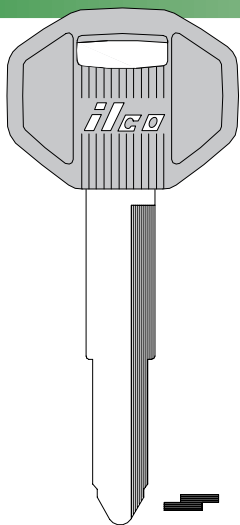

X121
DC3



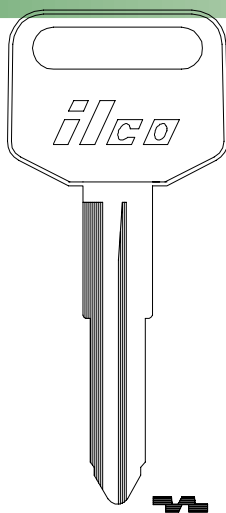

DC3-P (-PC)
-

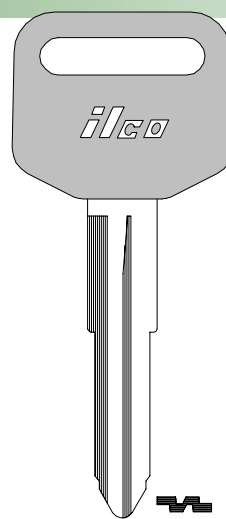



X160
HY2



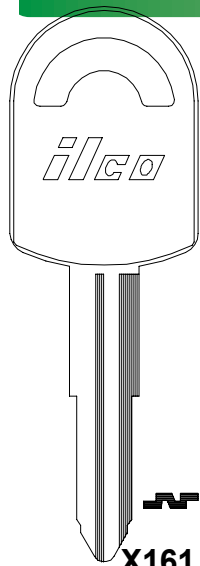

HY2-P
-

ILCO
EZ

HYUNDAI



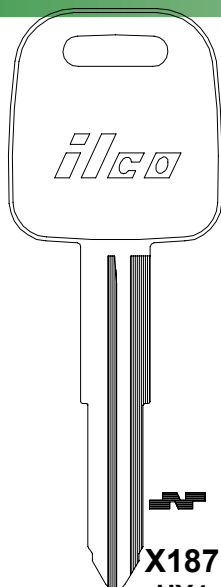

X161
HY3



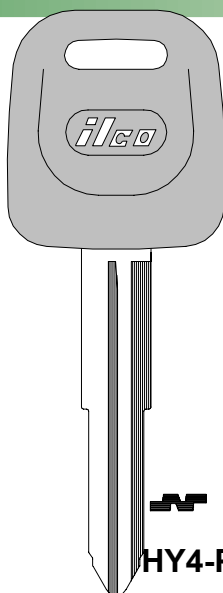

X187
HY4

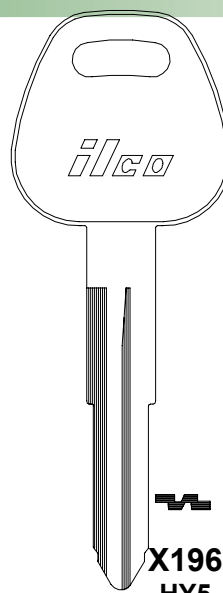



HY4-P
-

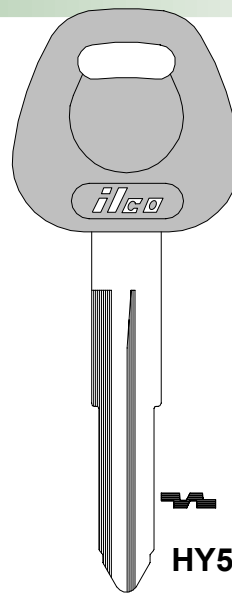



X196
HY5



HY5-P
-

ILCO
EZ

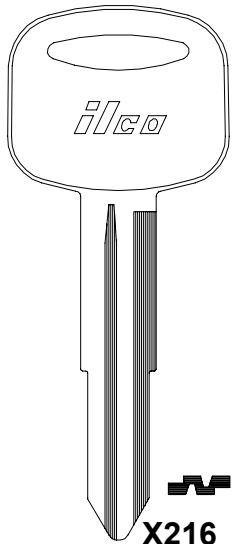
HYUNDAI



ILCO
EZ

X216
HY6

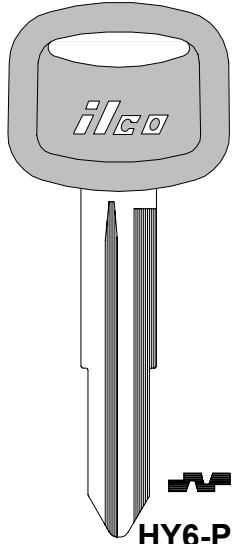

HY6-P
-

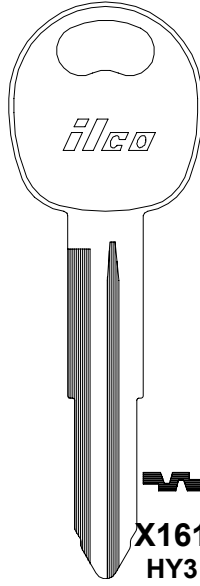

X161
HY3

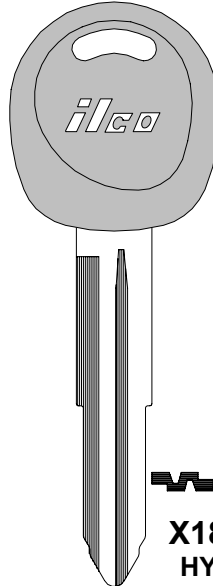

X187
HY4

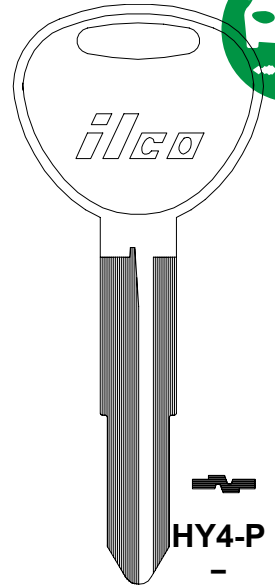

HY4-P
-



HYUNDAI

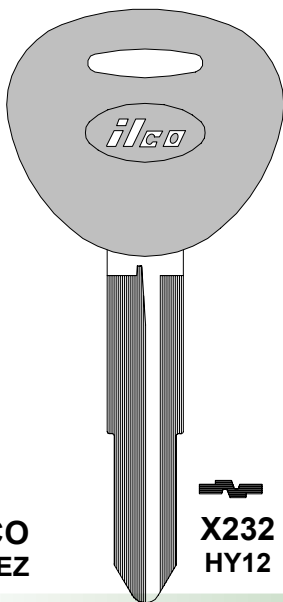

ILCO
EZ

X232
HY12

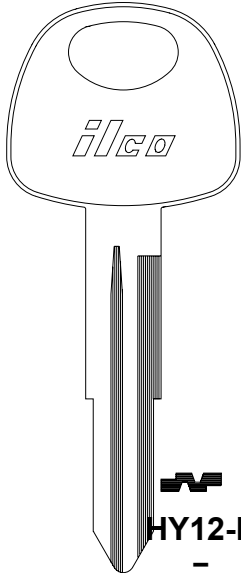

HY12-P
-

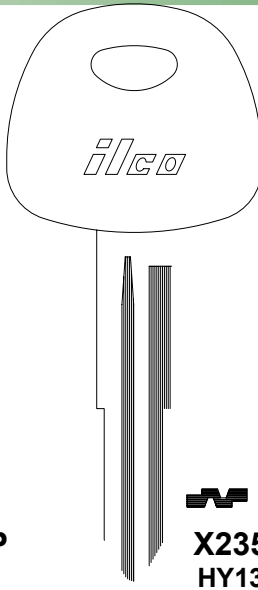

X235
HY13

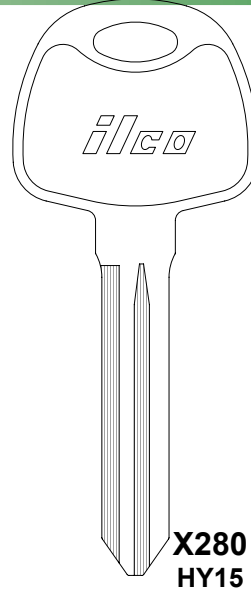

X280
HY15

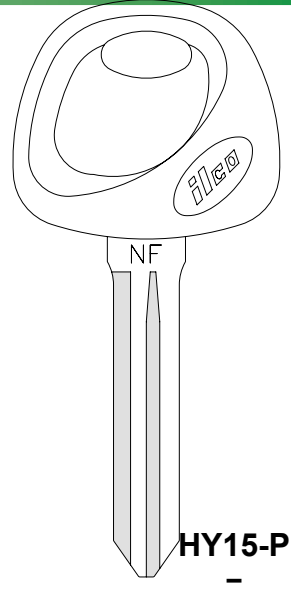

HY15-P
-

HYUNDAI

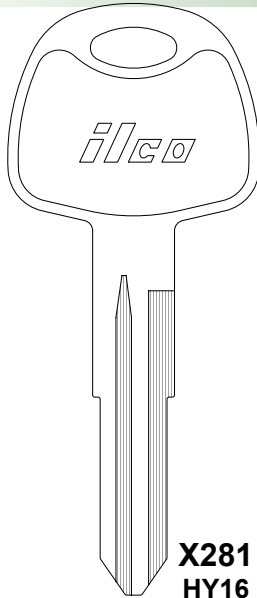

ILCO
EZ

X281
HY16

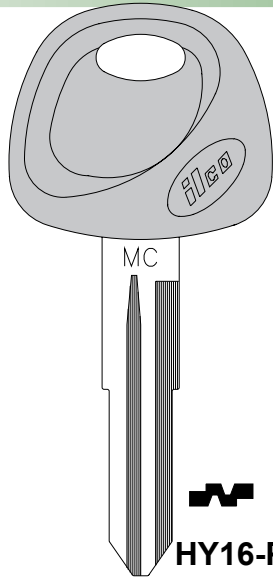

HY16-P
-

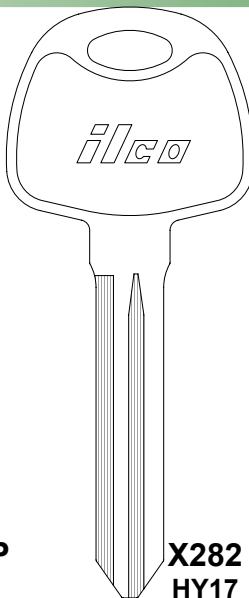

X282
HY17

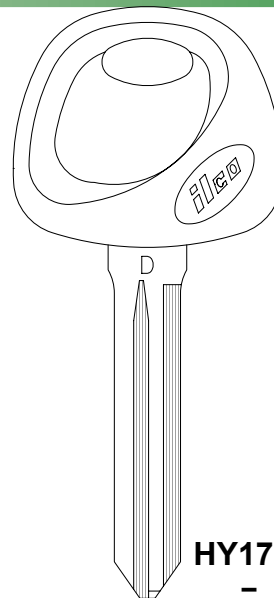

HY17-P
-

VEHICLE KEYS



HYUNDAI

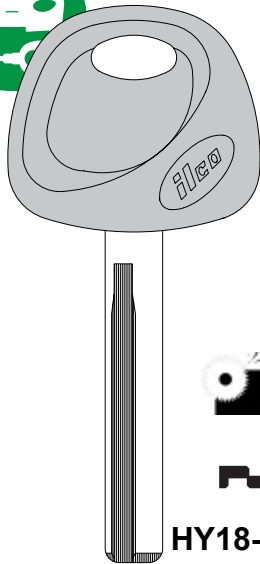

HY18-P

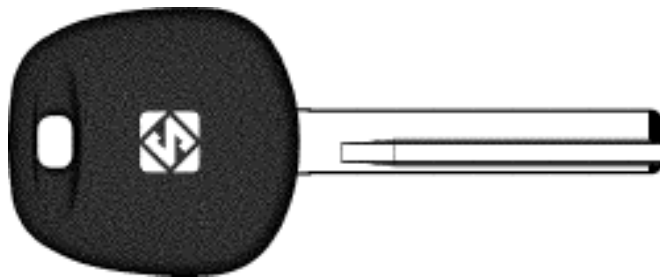

HY18-GTS

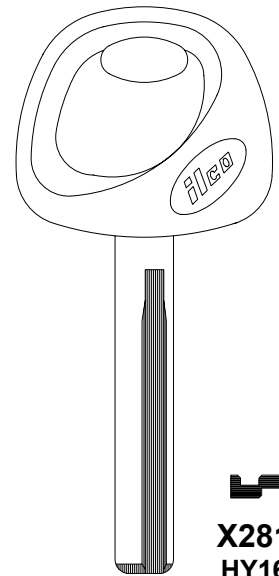

X281ILCO
HY16EZ



VEHICLE KEYS

HYUNDAI

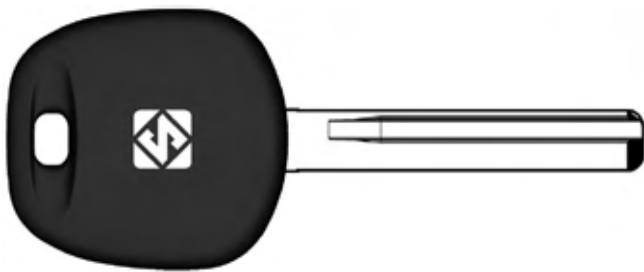

HY16-P

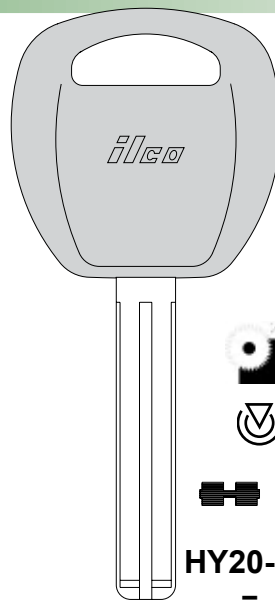

HY20-PT



HY21

ILCO
EZ

HYUNDAI

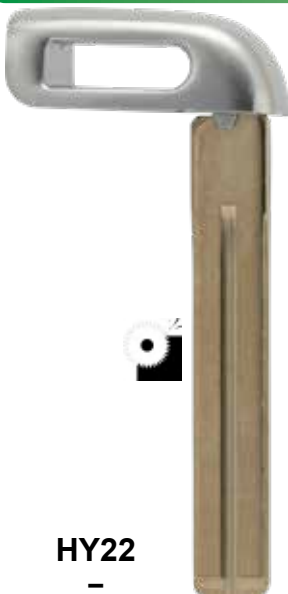

HY22

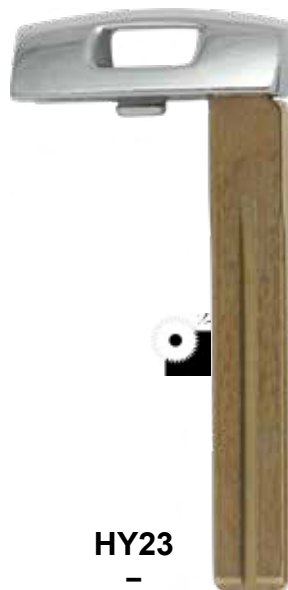

HY23

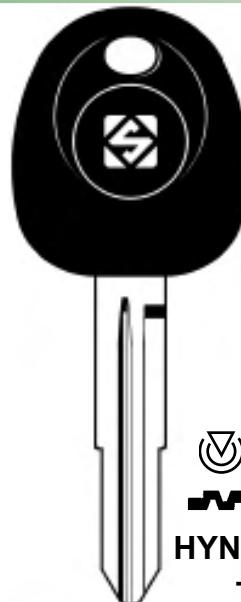

HYN6T14



HYN6MH
ILCO
EZ



HYUNDAI

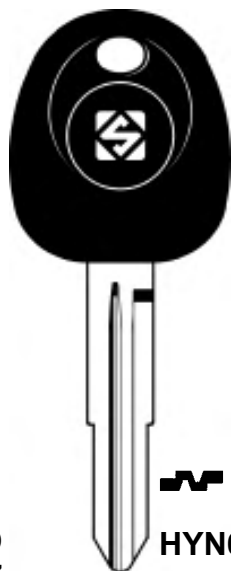

ILCO
EZ

HYN6-GTS
-



HY22
-

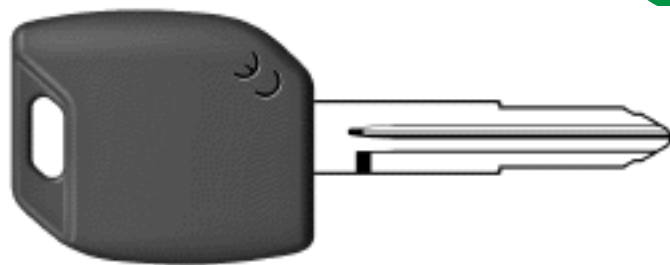

HY23
-

HYUNDAI



ILCO
EZ

HYN6T14
-

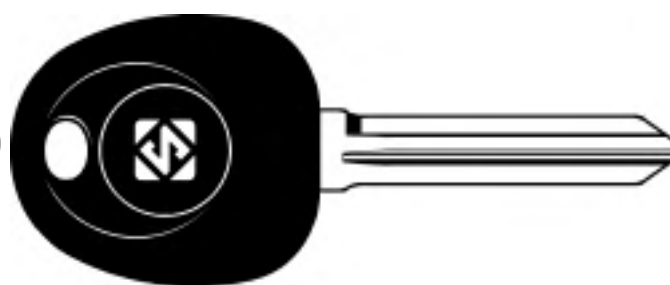

HYN6FB
-



HYUNDAI

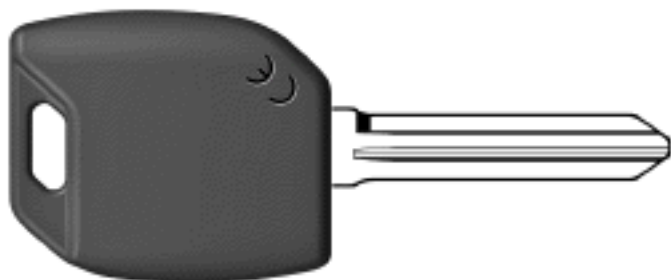

ILCO
EZ

HYN14MH
-

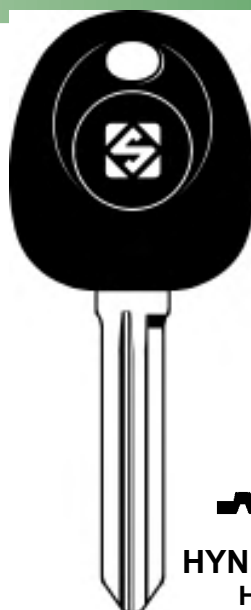

HYN14-GTS
HY16

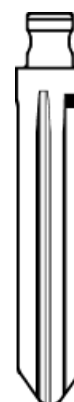

HYN14FB
-



HYUNDAI

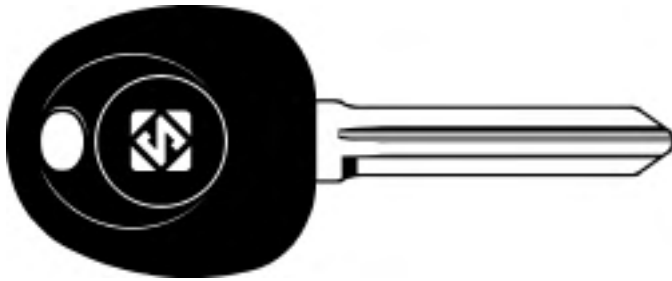

HYN14RT14

-



HYN14RMH

-

ILCO
EZ

VEHICLE KEYS

HYUNDAI

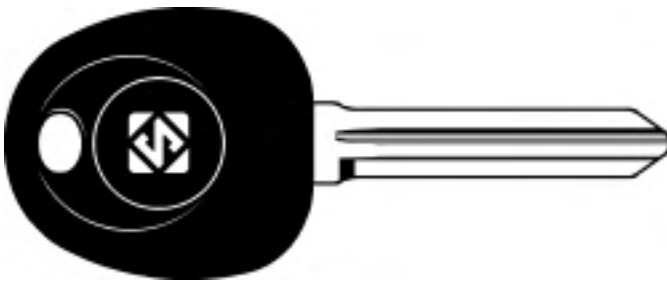

HYN14-GTS
HY16

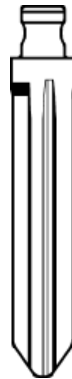

HYN14R-GTS

-

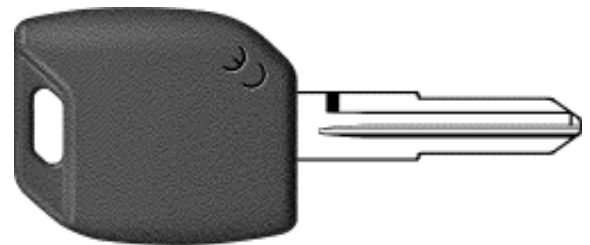

HYN15MH

-

ILCO
EZ

HYUNDAI

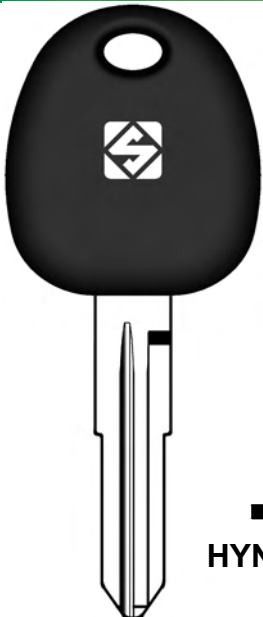

HYN15-GTS

-



HYN15FB

-



ILCO
EZ

SEC
1
PG
120



HYUNDAI

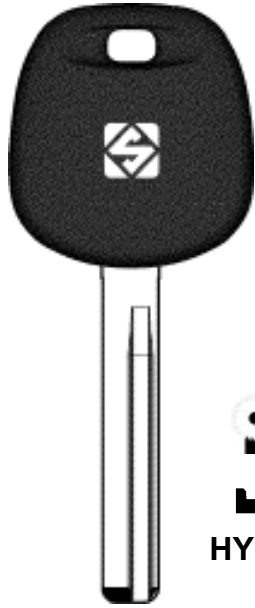

ILCO
EZ



HYN17RBTE-GTS
-

HYUNDAI

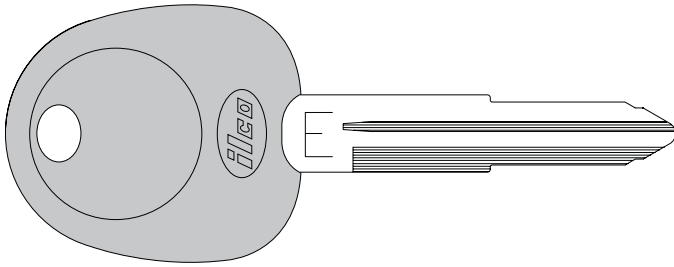

ILCO
EZ



HYO21-PT
-

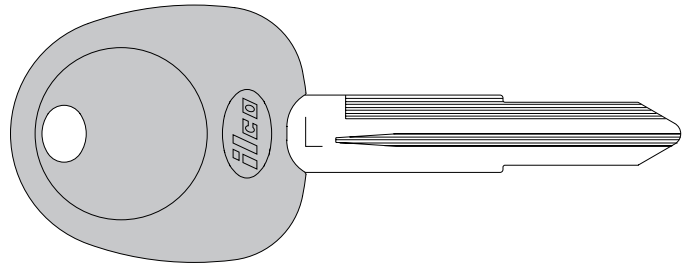



HYO22-PT
-

HYUNDAI

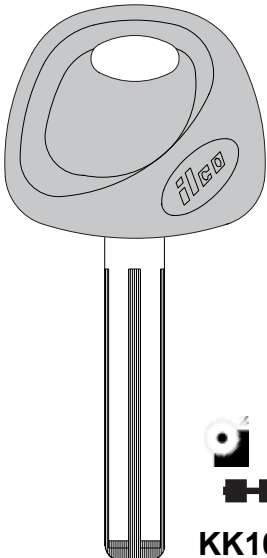

ILCO
EZ



KK10-P
-

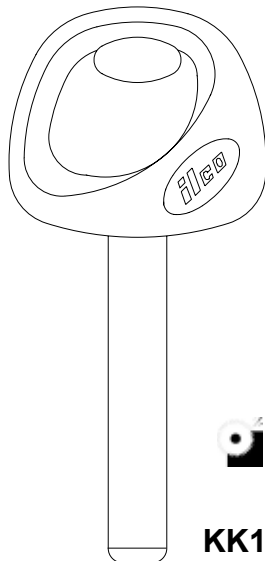



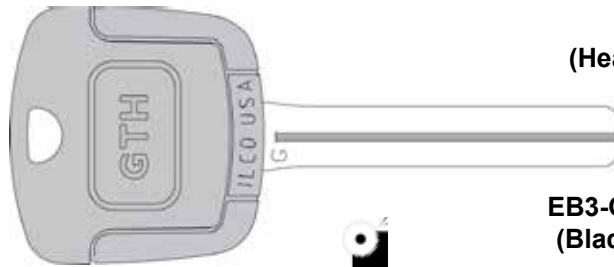

KK12-P
-



GTH
(Head Only)

EB3-G-TOY40
(Blade Only)



TOY40-GTK
(Complete Key)



VEHICLE KEYS



HYUNDAI



GTH
(Head Only)

EB3-F-TOY48
(Blade Only)



TOY48-GTK
(Complete Key)

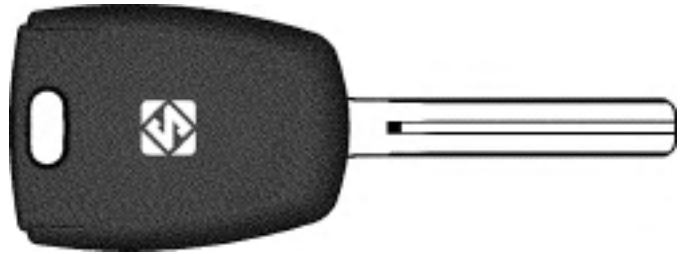

TOY49TE-GTS



ILCO
EZ

VEHICLE KEYS

INDAK

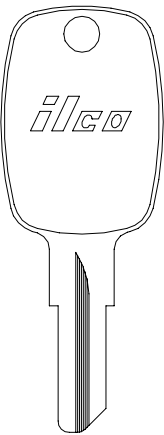

1098JD

-

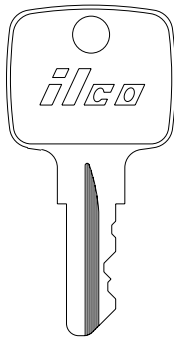

C1098JD

-

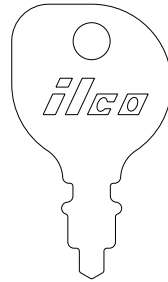

1148

-

INDIAN



1041T
CG16

ILCO
EZ

INFINITI

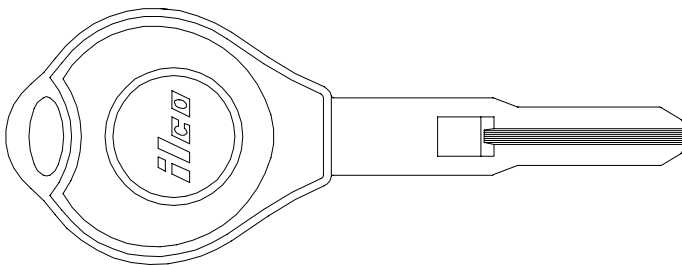

INF90

-

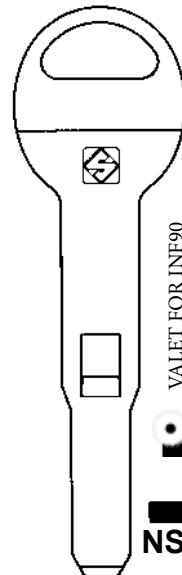

VALET FOR INF90



NSN10

-

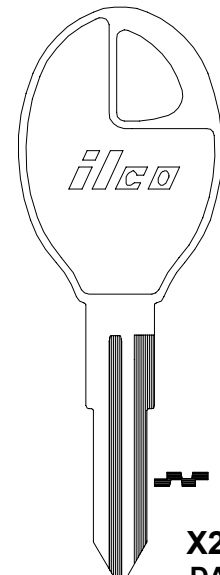

X210
DA31 ILCO
EZ

SEC 1

PG 122



INFINITI

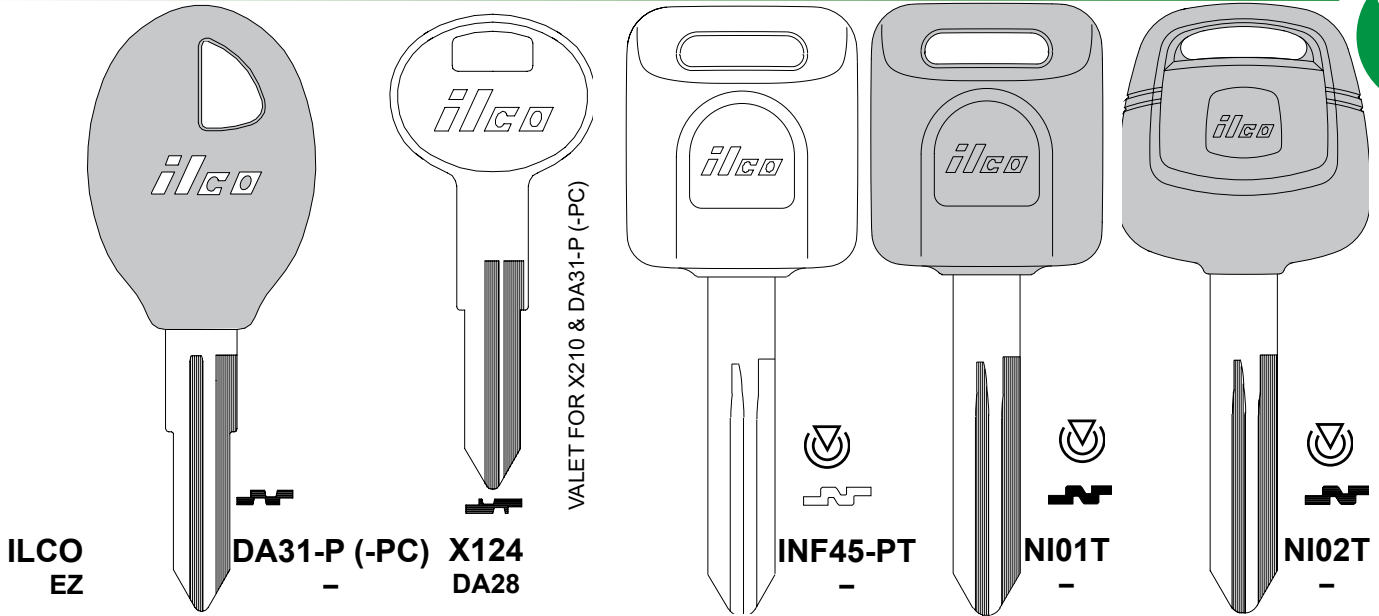

INFINITI

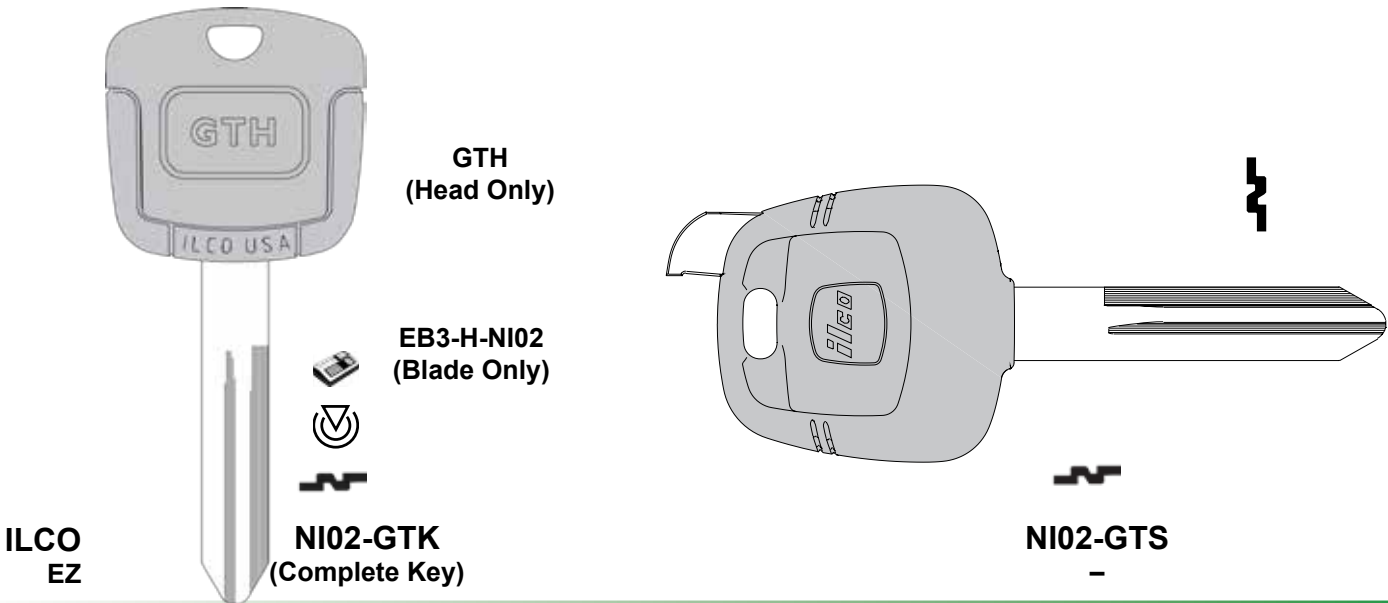

INFINITI

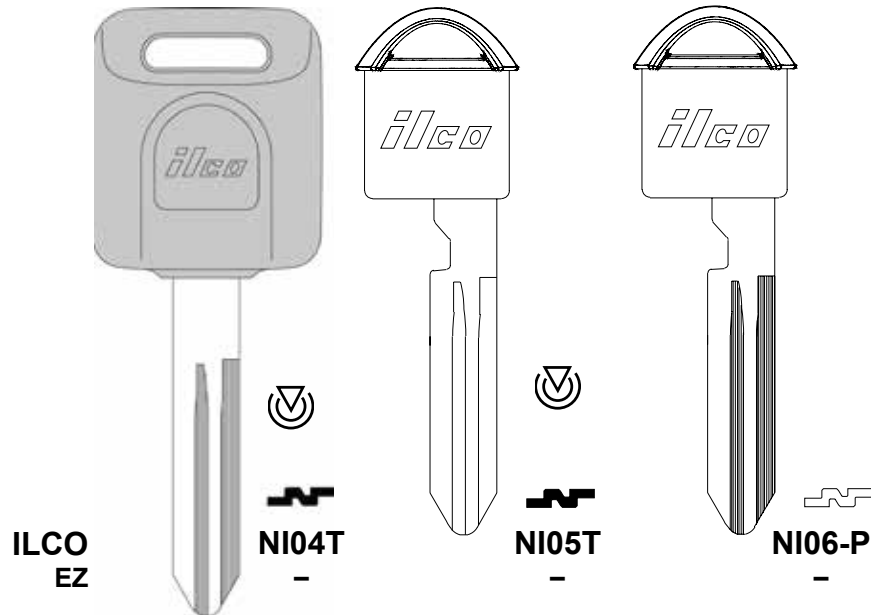

ISETTA





ISETTA

ISUZU

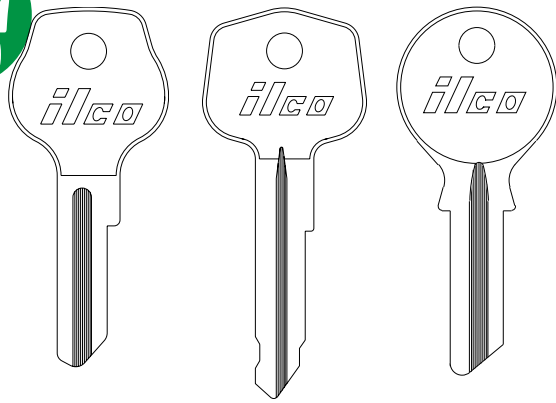

R62VB
-
63E
-
63L
-

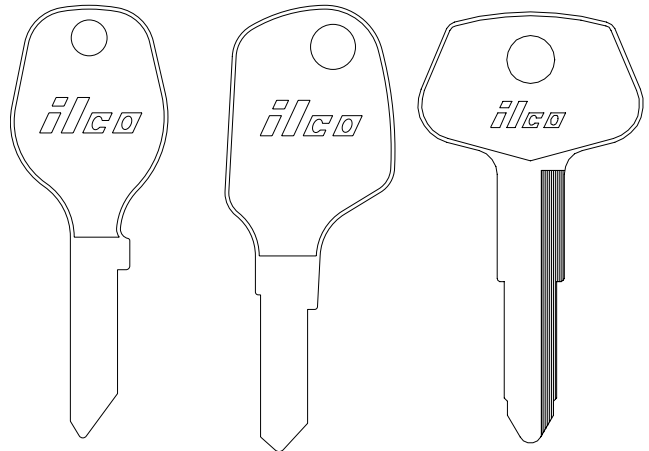

SZ1
-
SZ2
-
X54 DC1
ILCO
EZ

ISUZU

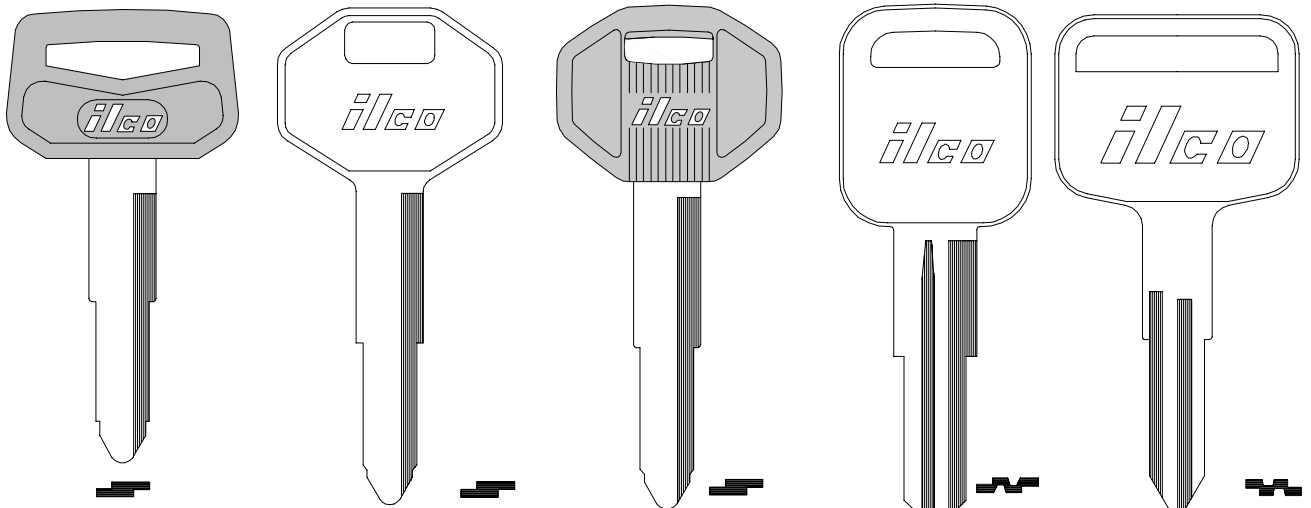

DC1-P
-
X121 DC3
-
DC3-P (-PC)
-
X143 B53
-
X154 B54
ILCO
EZ

HYUNDAI

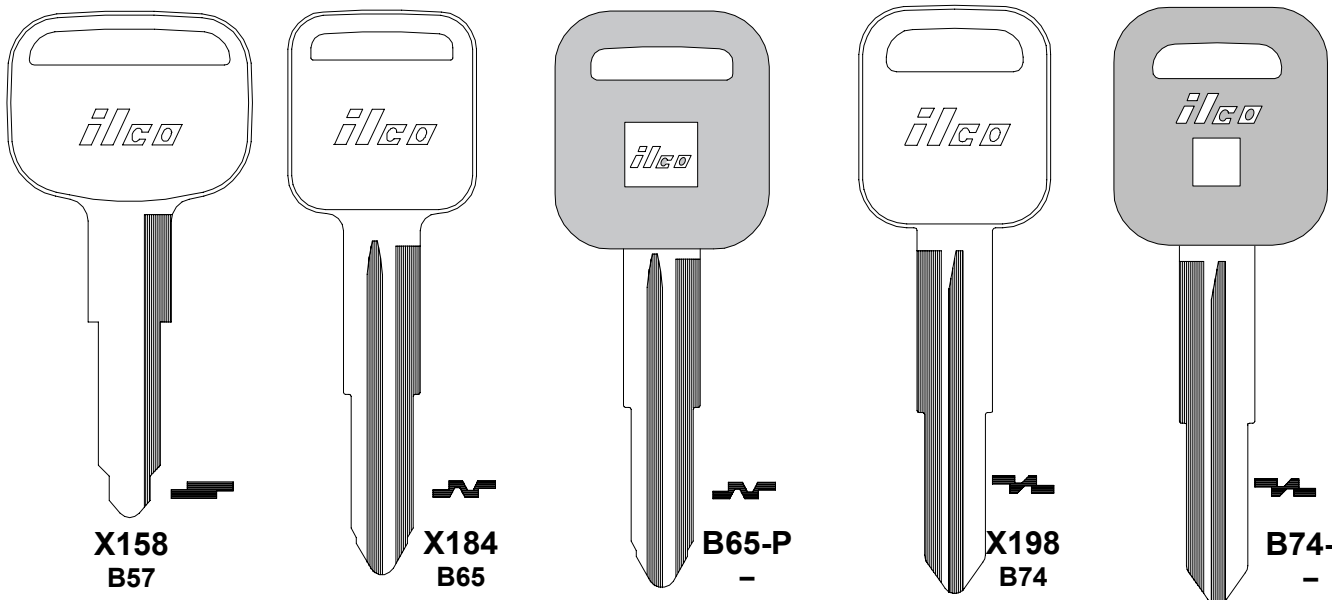

X158 B57
-
X184 B65
-
B65-P
-
X198 B74
-
B74-P ILCO
- EZ

VEHICLE KEYS



ISUZU

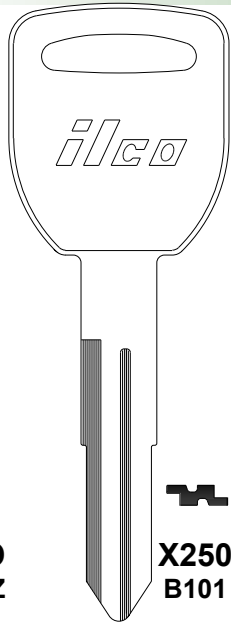

ILCO
EZ

X250
B101

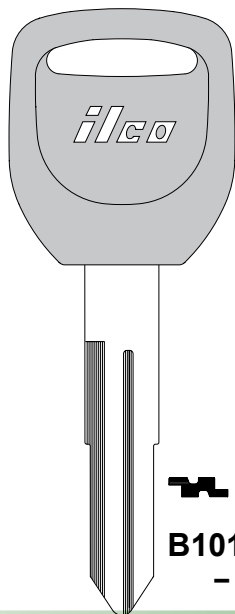

B101-P
-

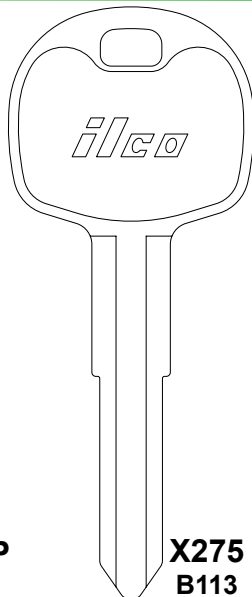

X275
B113

ITALJET

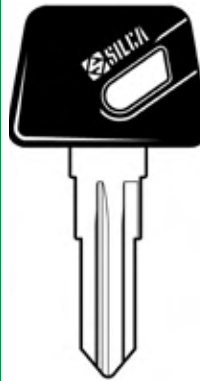

YH34P-SI
-

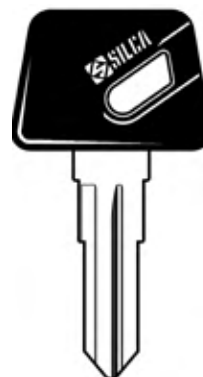

YH34RP-SI
-

ISUZU

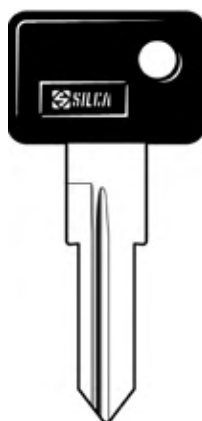

ILCO
EZ

ZD16RP-SI
-



ZD23RCP-SI
-

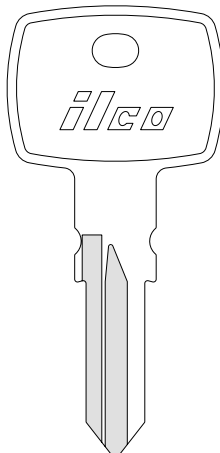

X270
TMC1

IVECO

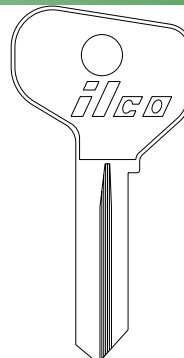

FT37
-

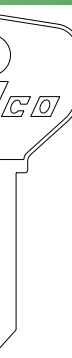

FT38
-

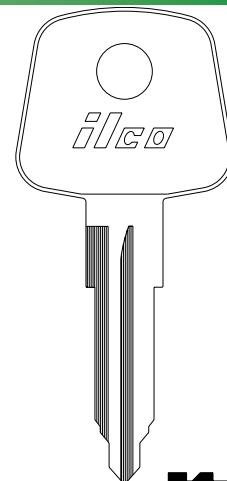

X50
AA3

IVECO

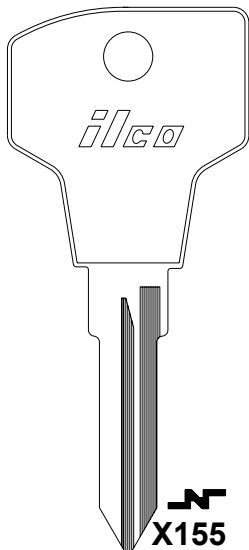

ILCO
EZ

X155
IV1

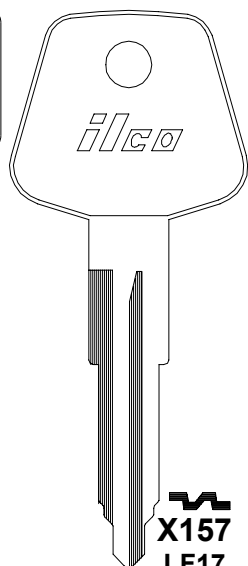

X157
LF17

JAGUAR

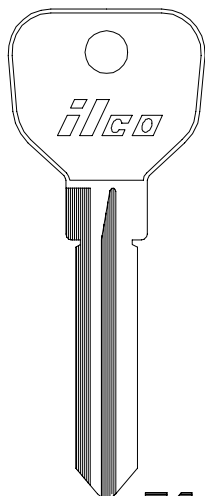

MG1
-

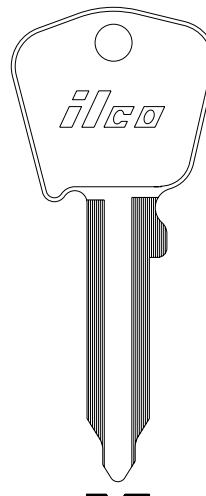

KL2
-

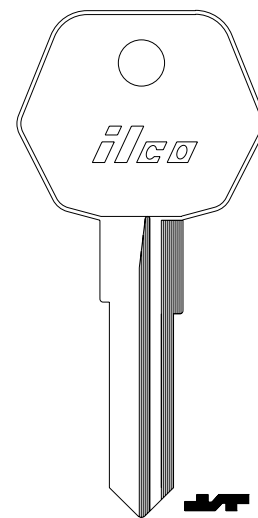

WB2
-



JAGUAR

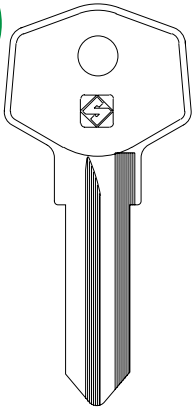

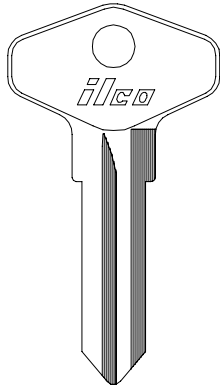

CEM5
-



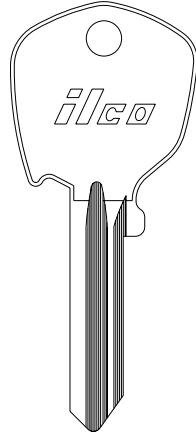

BL6
-

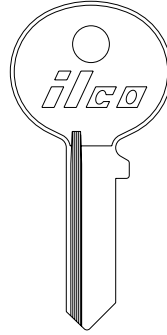



FT6R
F81E

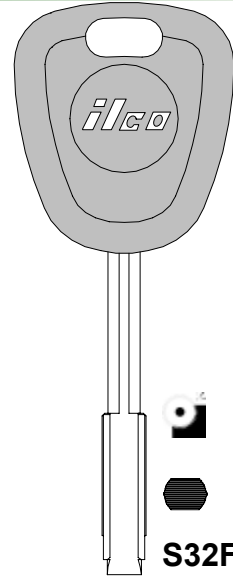



UN16
-



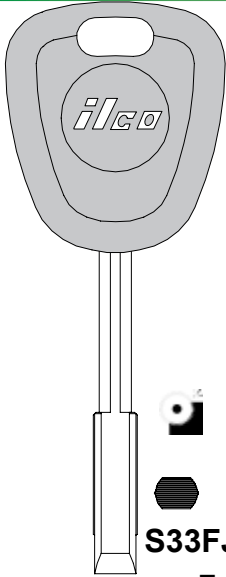

S32FJ-P ILCO
EZ

VEHICLE KEYS

JAGUAR





S33FJ-P
-

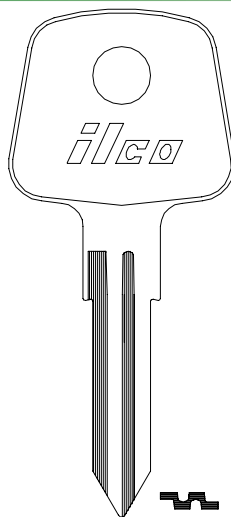

X51
AA2



62DC
-

62DG
-

62DM
-

62DH
-

62DP
-

62DK
-



R62DM
-



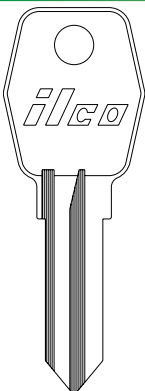

62DX 62FS ILCO
EZ

JAGUAR





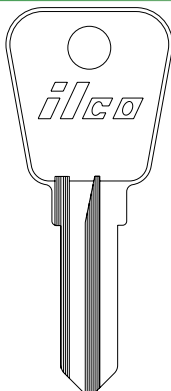

62FG
-

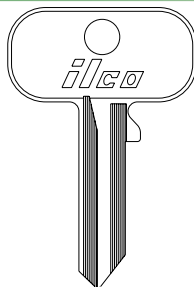



62FT
-

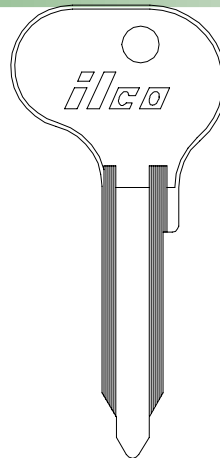



B62DR B62DP
-

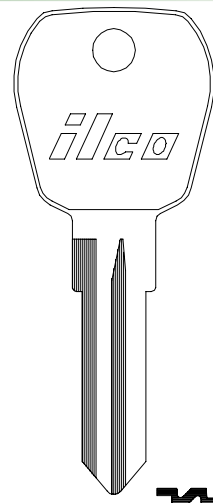

VW77
-





X86
FC7

ILCO
EZ

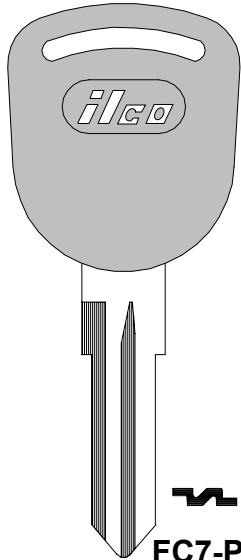

JAGUAR



ILCO EZ FC7-P -

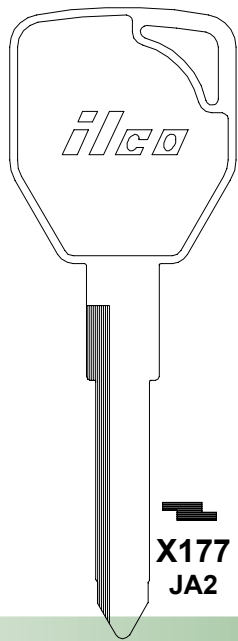

X177 JA2

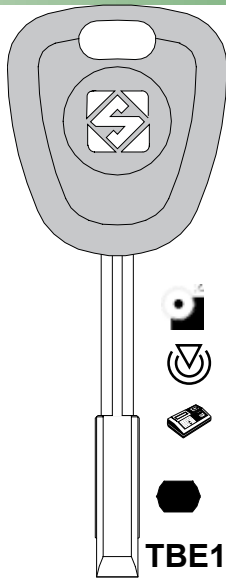

TBE1T5 -

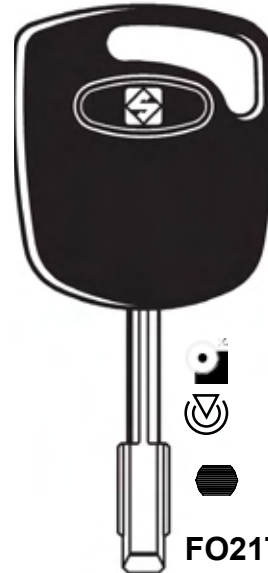

FO21T7-SI -

JAGUAR

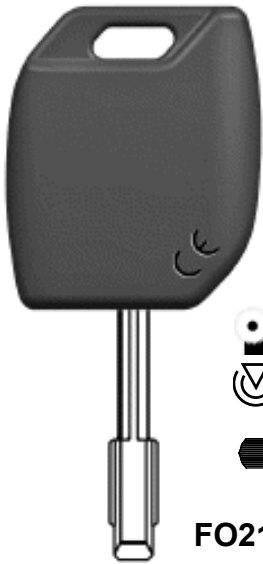

ILCO EZ FO21MH -

JAWA CYCLE

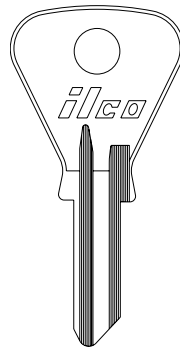

J66M -

JEEP

SEE AMERICAN MOTORS OR CHRYSLER

JOHN DEERE

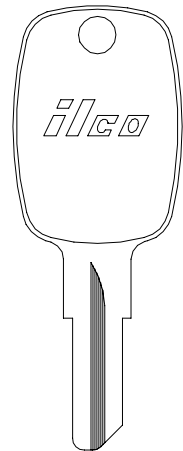

1098JD -

JOHN DEERE

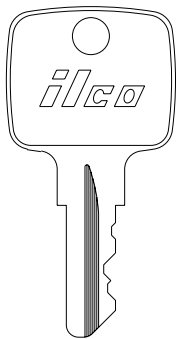

ILCO C1098JD EZ -



D1098JD -

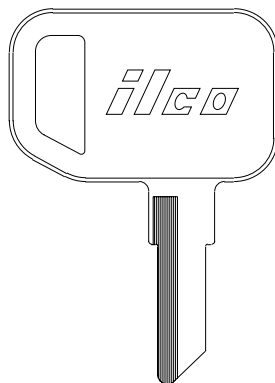

E1098JD -



F1098JD -

JOHNSTON MOTORS

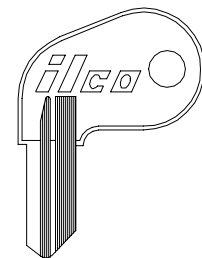

OM10 -

VEHICLE KEYS





VEHICLE KEYS

JOHNSTON MOTORS

KAISER FRAISER

KAWASAKI

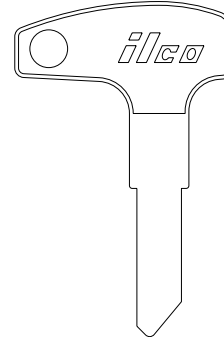
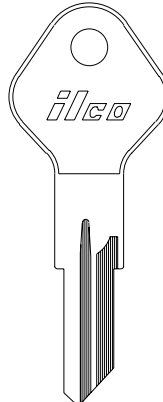
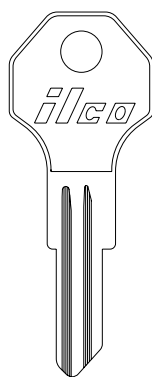
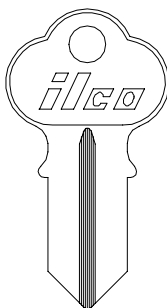
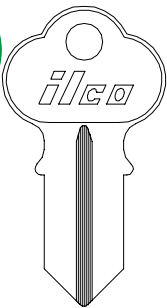

1041G
CG1



1041GA
CG2



H122AL H122ALR



K122AR



KA1



KA2

ILCO
EZ

KAWASAKI

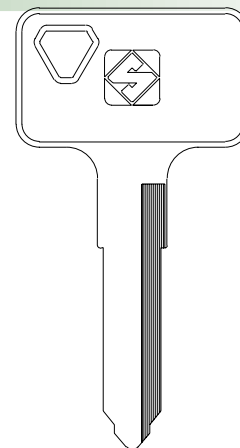
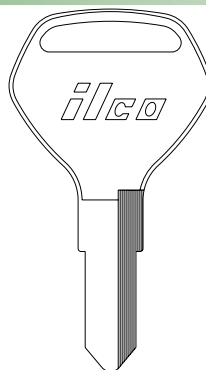
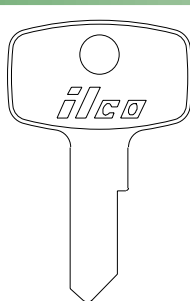
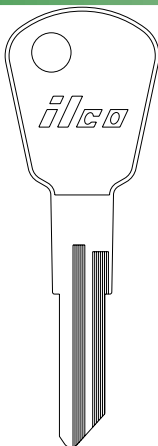

KA3



KA4



KA8



KA12



KW14



KW14R ILCO
EZ

KAWASAKI

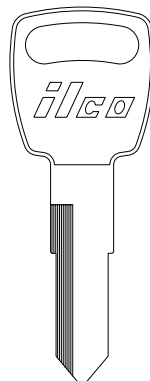
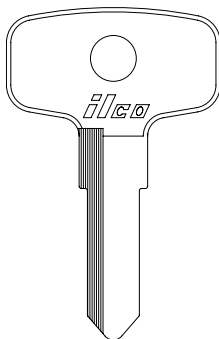
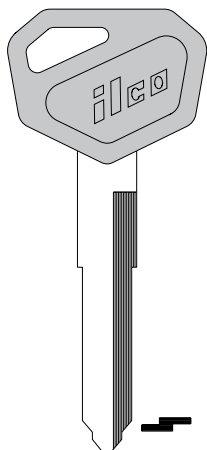
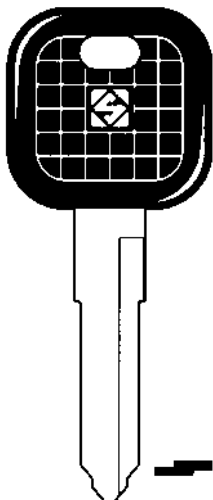

X24
KA7

X40
KA5

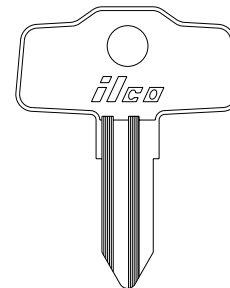

KW14AP

KW15BP

X18
YH21

X23
KA6



X34



X41

ILCO
EZ

SEC
1
PG
128



KAWASAKI

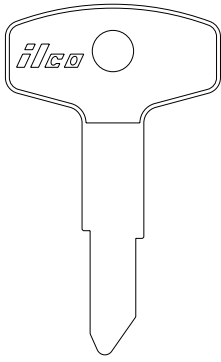

ILCO
EZ X35
-

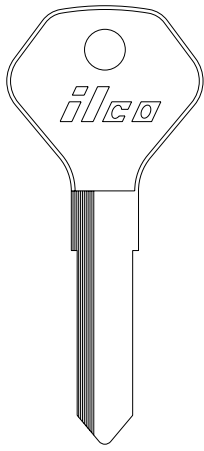

X90 X91
-

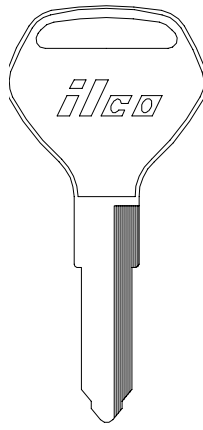

X103
KA14

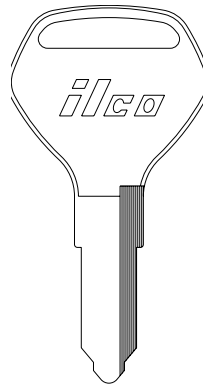

X104
KA13

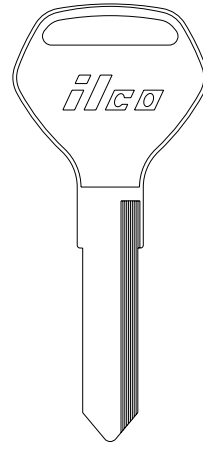

X105 X106
KA11 KA15

KAWASAKI

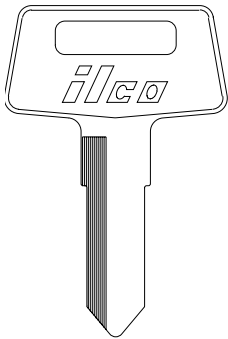

ILCO
EZ X254
-

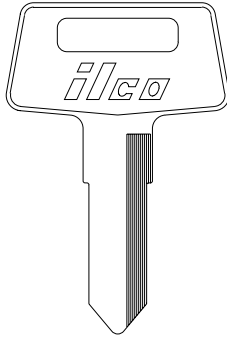

X255
-

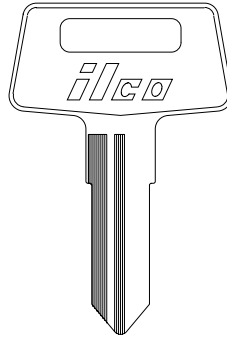

X256
-

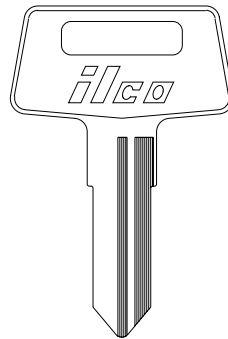

X257
-

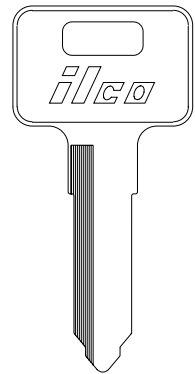

X258
-

KAWASAKI

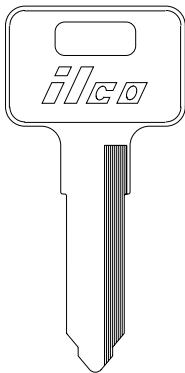

ILCO
EZ X259
-

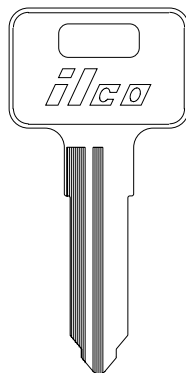

X260
-

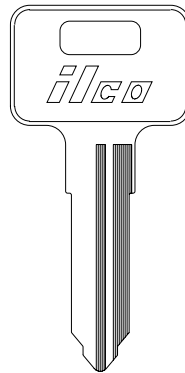

X261
-

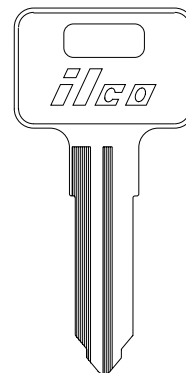

X262
-

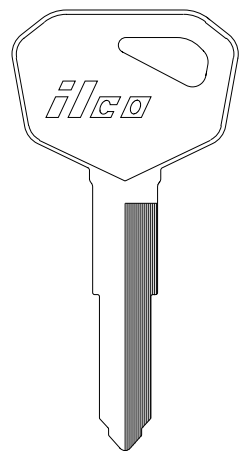

X266
KA16



KAWASAKI

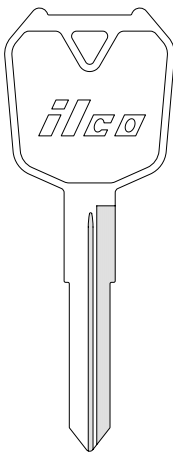

X278
KA33

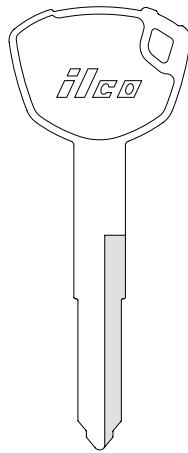

X279
KA34

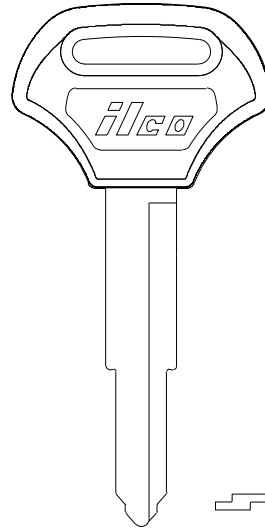

KW16CP-SI
-



KW12-SI
-

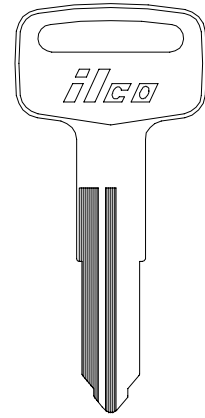

X117
YH48

ILCO
EZ

VEHICLE KEYS

KAWASAKI

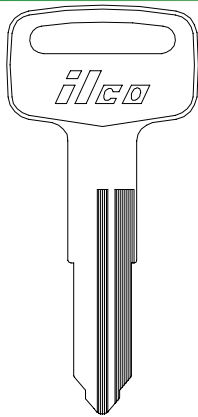

X118
YH49

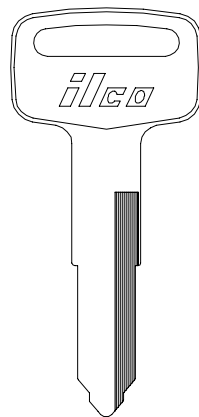

X119
YH47

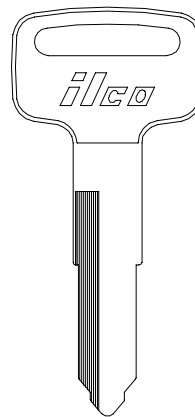

X120
YH46



KW12BP-SI
-

ILCO
EZ

KAWASAKI



KW16MH
-

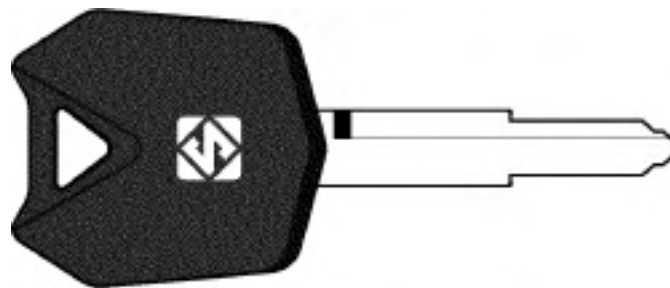

KW16-GTS
-



SR61N
-

ILCO
EZ

KAWASAKI

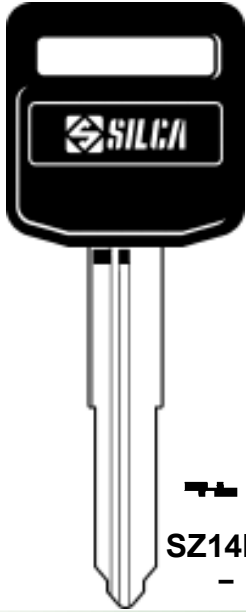

ILCO
EZ

SZ14RP
-

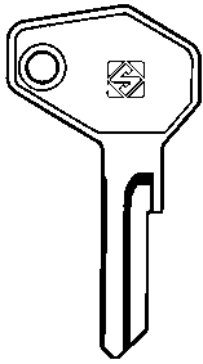

ZD7-SI
-

KENWORTH

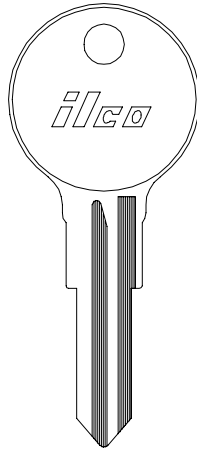

X53
V32

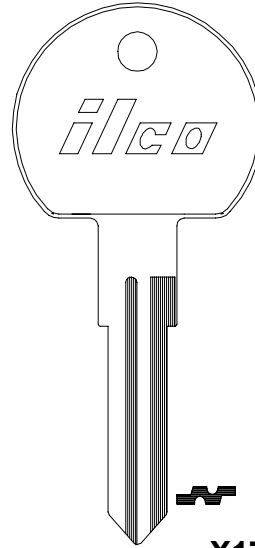

X170
NE48

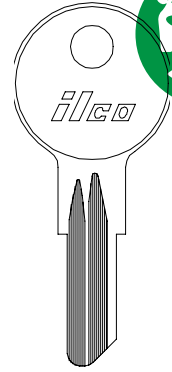

1098DB
B5



KENWORTH

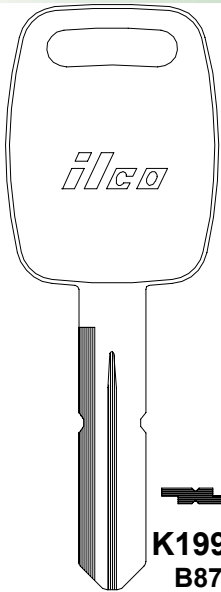

ILCO
EZ

K1994
B87

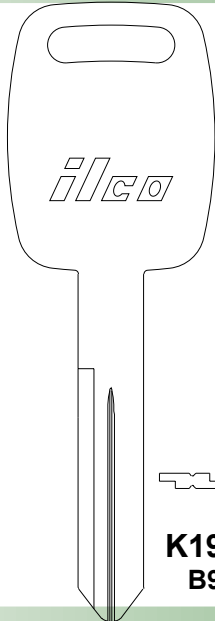

K1995
B94



1656
-



1657
-

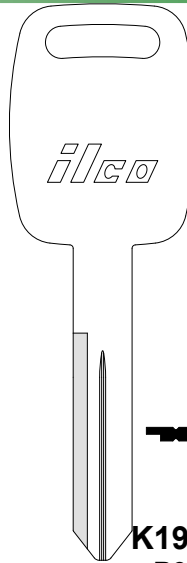

K1995
B94

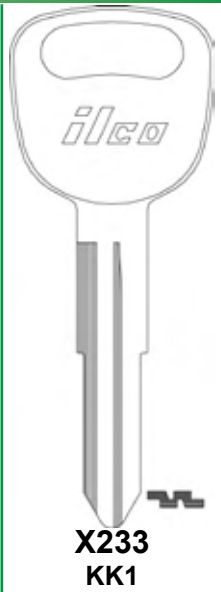

X233
KK1

KIA

KIA

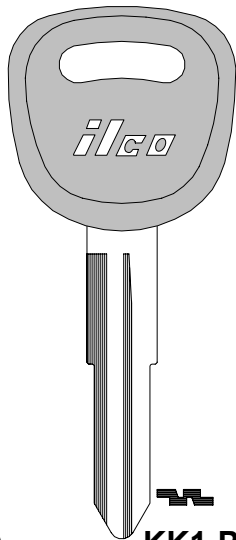

ILCO
EZ

KK1-P
-

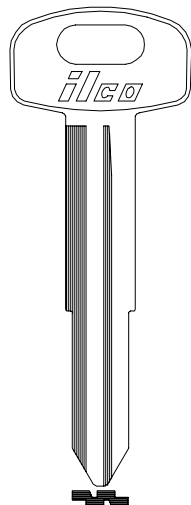

X240
KK2

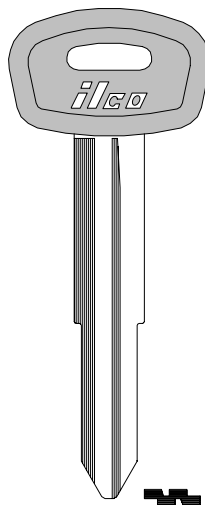

KK2-P
-

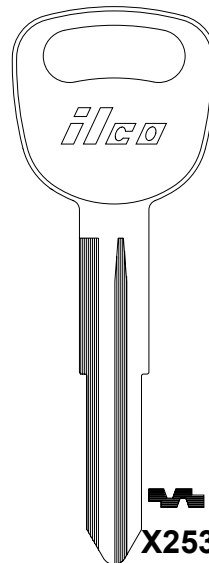

X253
KK3

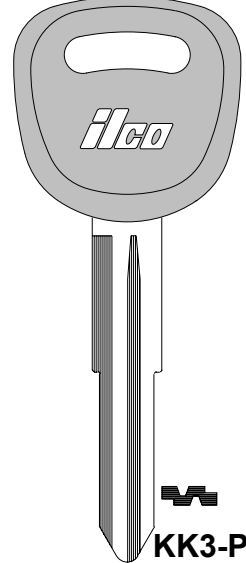

KK3-P
-

VEHICLE KEYS



KIA

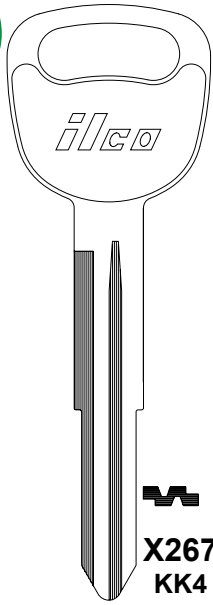

X267
KK4

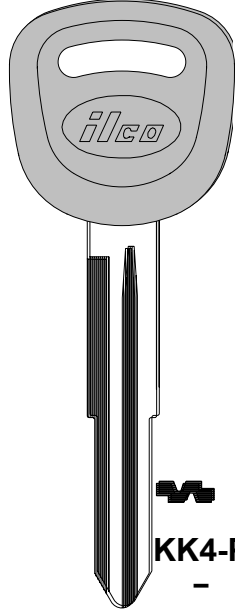

KK4-P
-

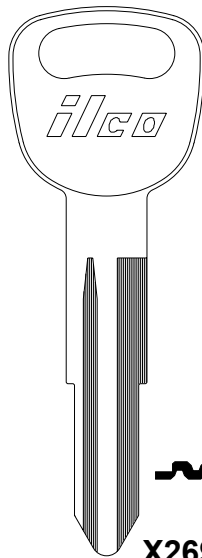

X269
KK5

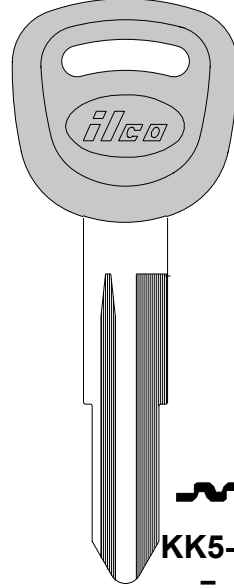

KK5-P
-

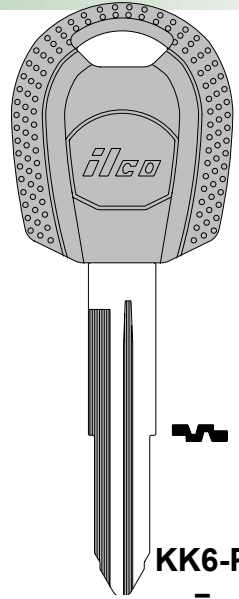

KK6-P ILCO
- EZ

VEHICLE KEYS

KIA

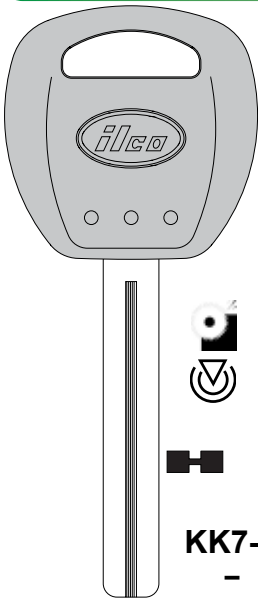

KK7-P
-

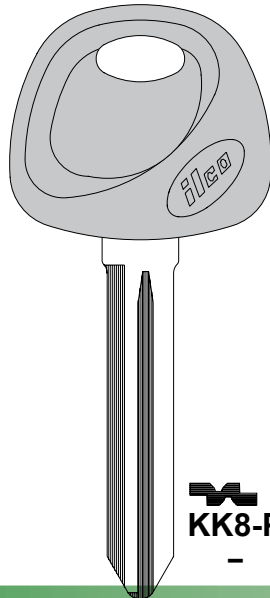

KK8-P
-

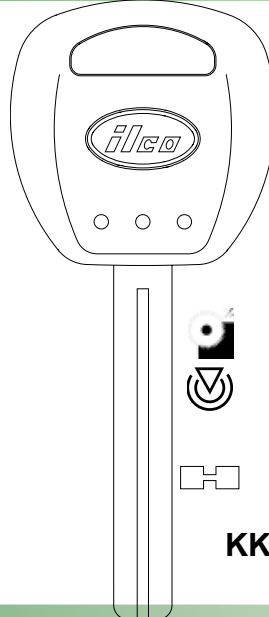

KK9-PT
-

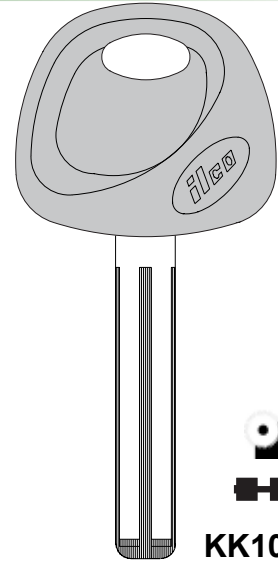

KK10-P ILCO
- EZ

KIA

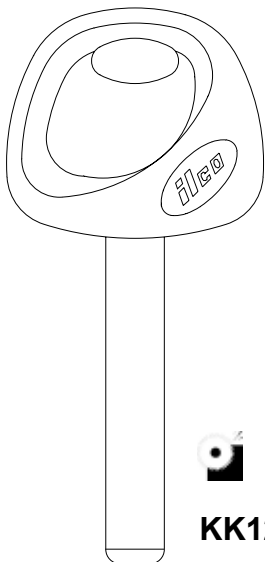

KK12-P
-

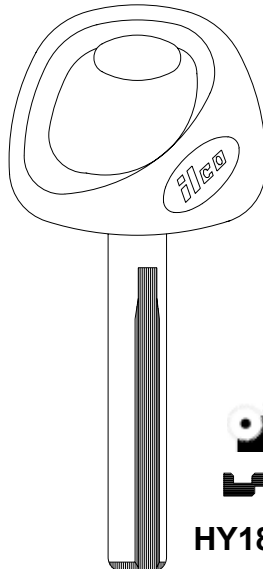

HY18R-P
-



HY18R-GTS
-

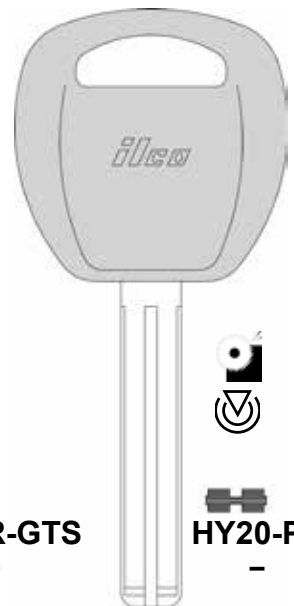

HY20-PTILCO
- EZ



KIA



HY21
-

ILCO
EZ



HY22
-

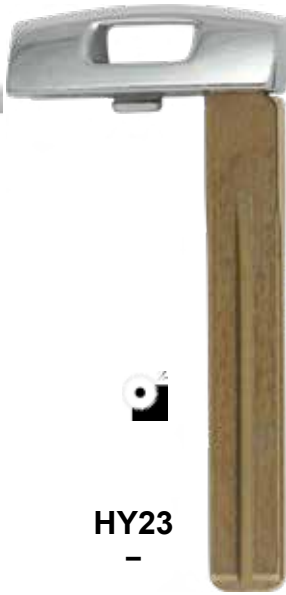

HY23
-



HYN14RT14
-



KIA



HYN14RMH
-

ILCO
EZ

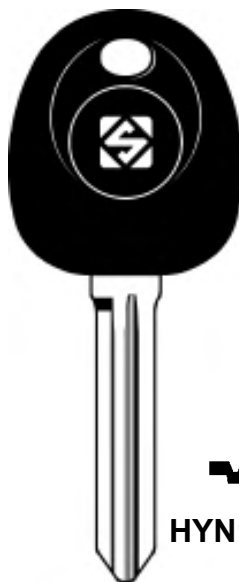

HYN14R-GTS
-



HYN7RMH
-



KIA

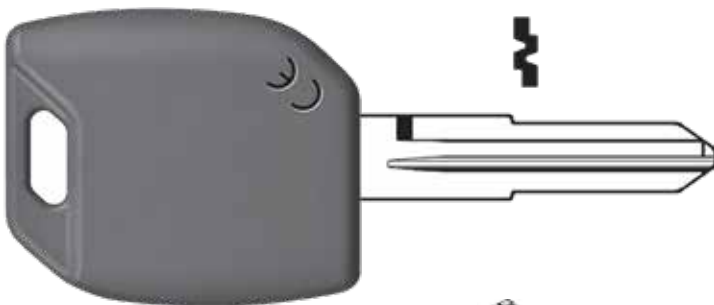

HYN15MH
-

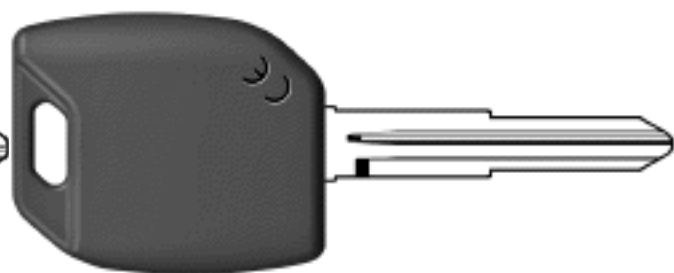

KIA3RMH
-



ILCO
EZ



VEHICLE KEYS



KIA

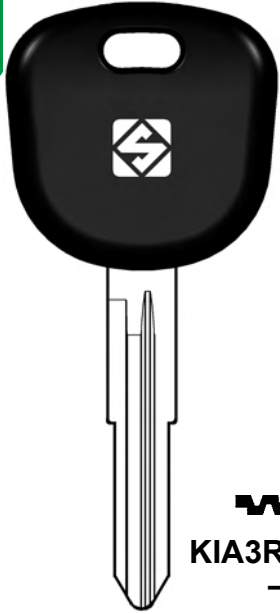

KIA3R-GTS
-



KIA3R-FB
-

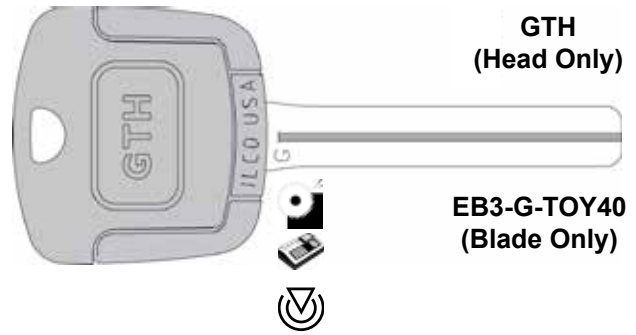

GTH
(Head Only)

EB3-G-TOY40
(Blade Only)

TOY40-GTK
(Complete)

ILCO
EZ

KIA





GTH
(Head Only)

EB3-F-TOY48
(Blade Only)



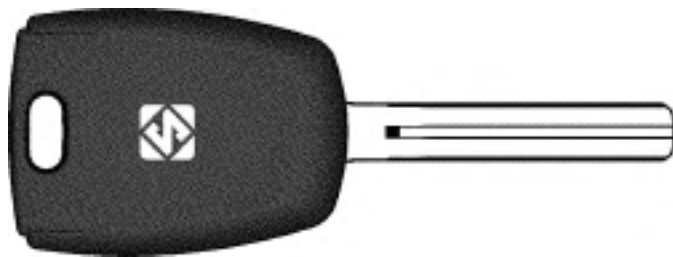

TOY48-GTK
(Complete Key)



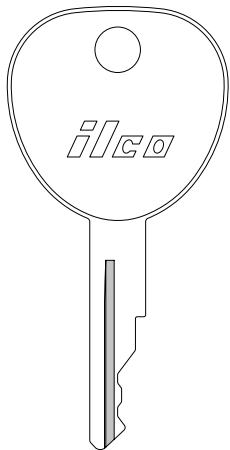

TOY49-GTS
-

ILCO
EZ

KIOTI

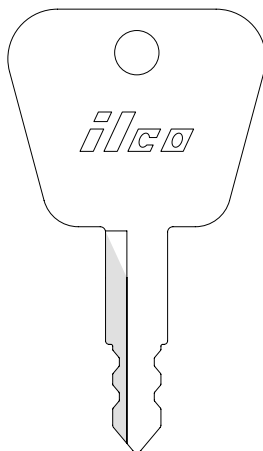

1694
KT1



1695
KT2

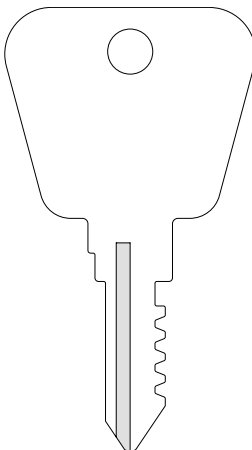

1696
KT3

KOMATSU

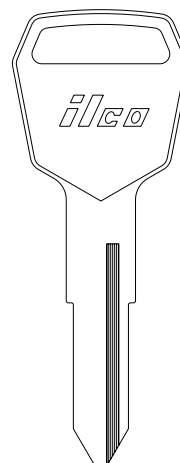

1519
-

KUBOTA

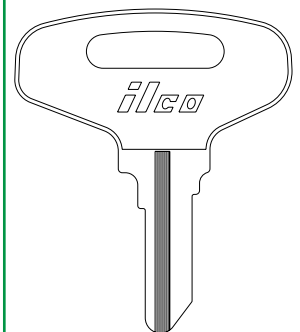



1539
-

ILCO
EZ

VEHICLE KEYS

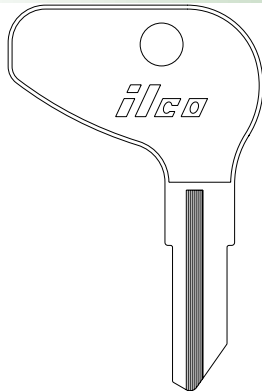

KUBOTA



ILCO
EZ

1540

-

KYMCO

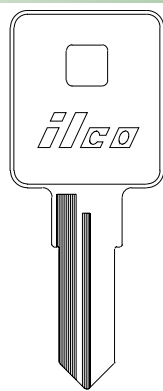

X234
HYD13

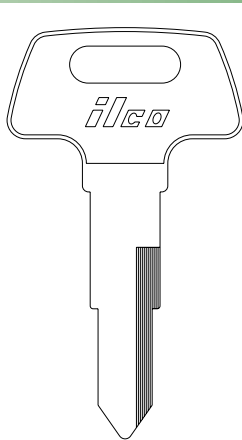

X84
HD74

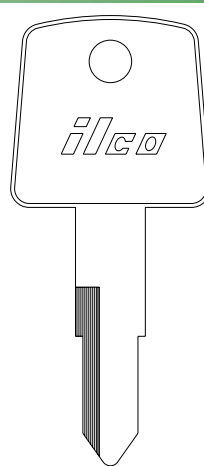

X138
HD75

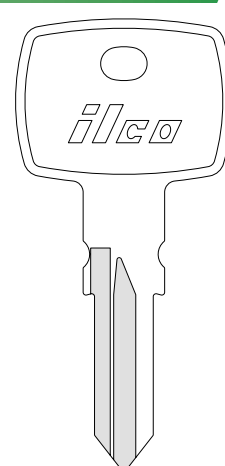

X270
TMC1

KYMCO

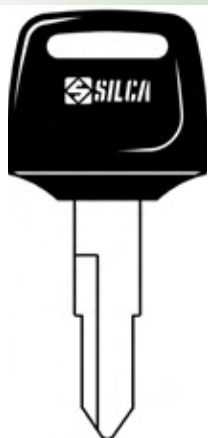

ILCO
EZ HON31CP-SI



KYM1P-SI

-



KYM1RP-SI

-

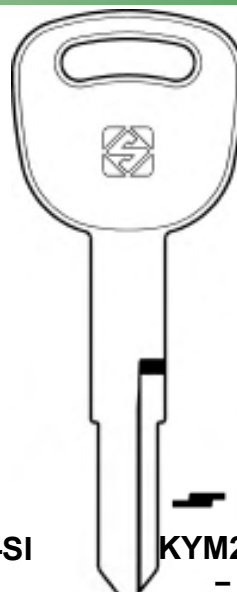

KYM2-SI

-



ZD24RDP

-

L. K. W.

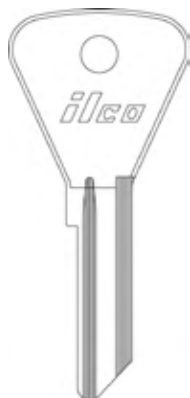

ILCO
EZ

BM1

-



YM3

-



NE10

-



62VG

-



62VH

-



L. K. W.



B62G



63F



63L



R63W



F65

ILCO
EZ



LADA

LAMBORGHINI

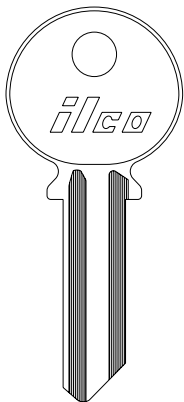

SP9



FT37



FT38

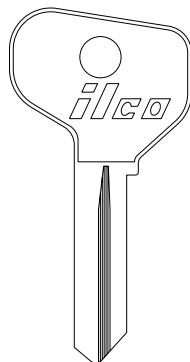

FT37



FT38

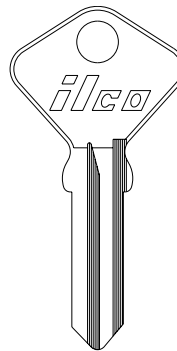

F91C

F91CR

F91C2

F91C8

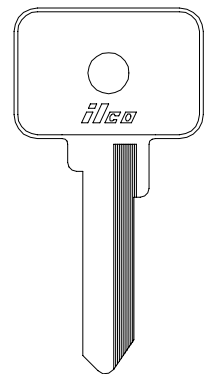

X109
FT43

ILCO
EZ



LAMBORGHINI LAMBRETTA

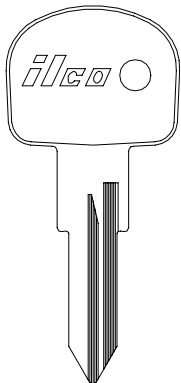

X152
FT46

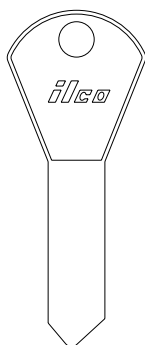

LA1

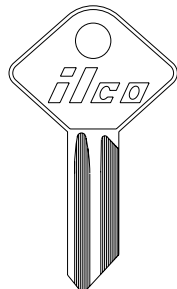

LA2

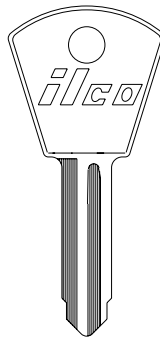

LA3

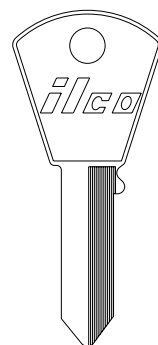

LA4

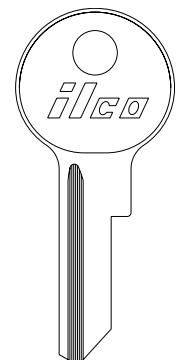

NE4

ILCO
EZ



VEHICLE KEYS

SEC
1
PG
136



LAMBRETTA

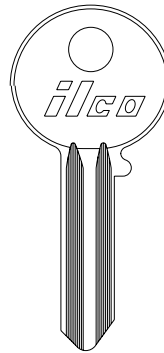
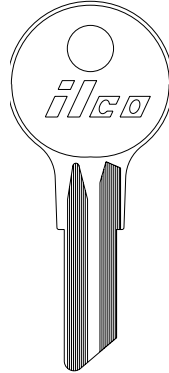
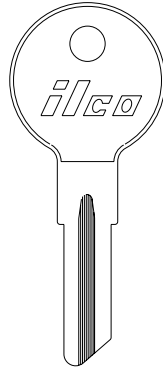

LA10
-

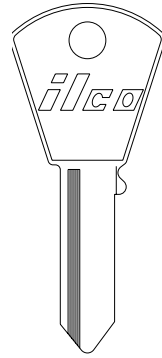

LA11
-

LA12
-



ILCO
EZ



LA5
-

LA14
-

LA6
-

LA7
-

LA8
-

LA9
-

LA13
-

LAMBRETTA

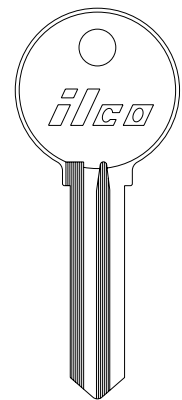
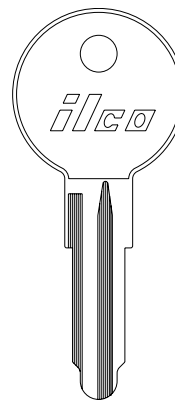
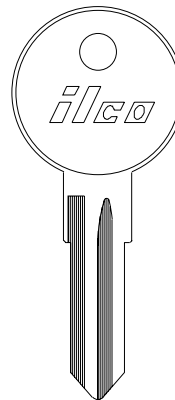
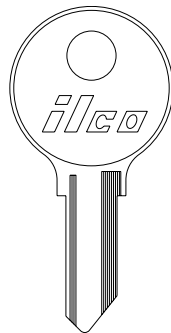
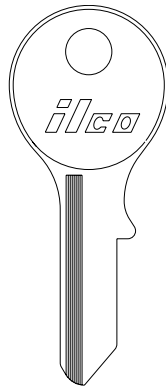
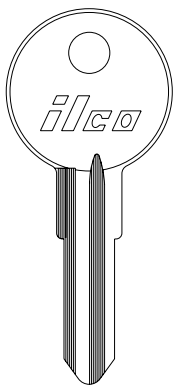

ILCO
EZ



61H
-

R61H
-

H61N
-

62VA
-

YR62
-

66A
-

66BB
-

LAMBRETTA

LANCIA

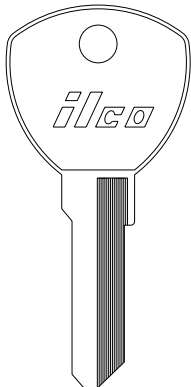
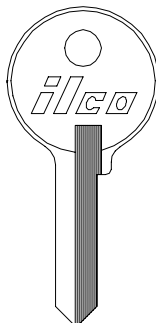
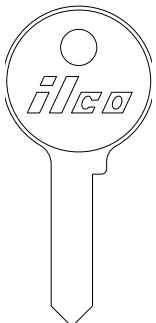

GT2
-

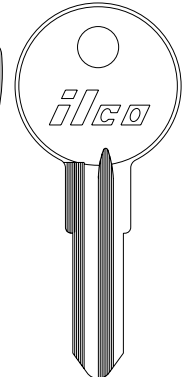
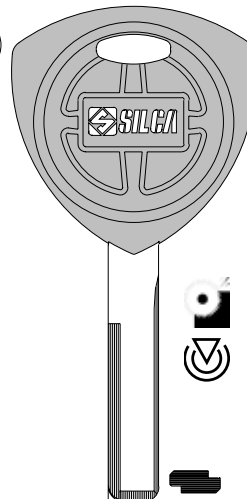
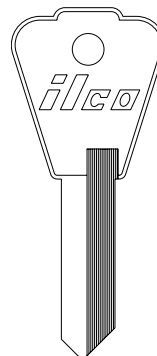

ILCO
EZ

125C
-

125CR
-

GT1
-

GT3
-

GT4
-

GT5
-

LN4
-

SIP16T2
-

61H
-

R61H
-





LANCIA



61NA
-

R61NA
-

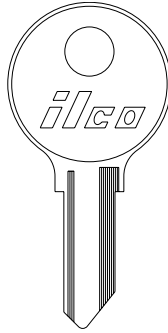

62VA
-

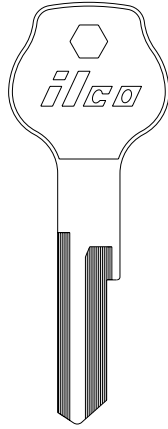

63K
-

63W
-

R63K
-

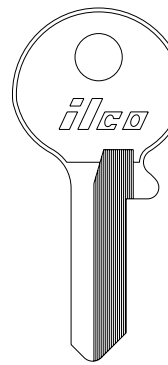

64AL
-

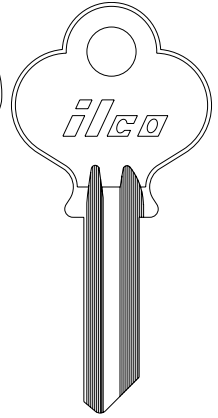

64Y
-

ILCO
EZ

61N
-

VEHICLE KEYS

LANCIA

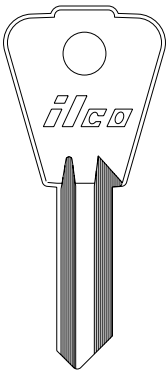

F68C
-

LAND ROVER

SEE
ROVER

LAVERDA

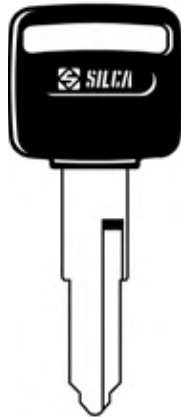

ZD21P-SI
-

LEXUS

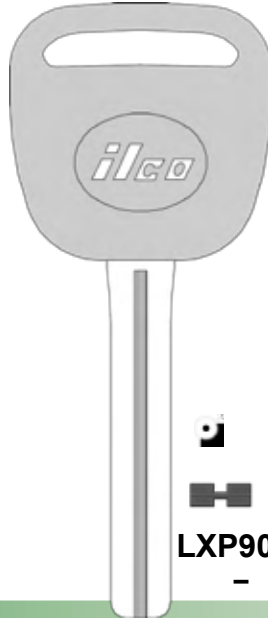

LXP90-P
-

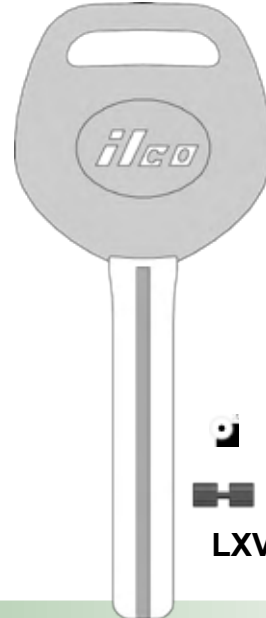

VALET FOR LXP90-P
LXV90-P
ILCO
EZ

LEXUS



TOY40BT4
-

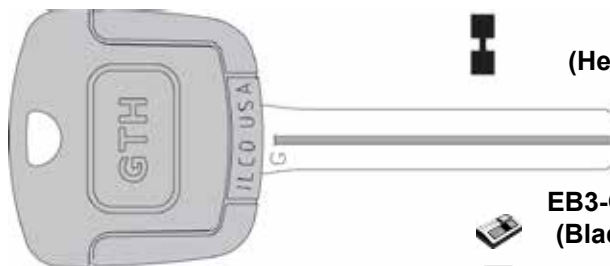

GTH
(Head Only)
EB3-G-TOY40
(Blade Only)
TOY40-GTK
(Complete)

ILCO
EZ



LEXUS

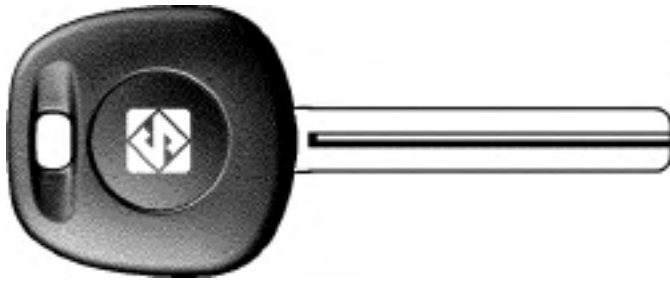

ILCO
EZ

TOY40-GTS
-

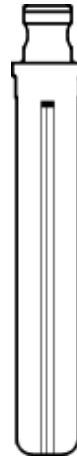

TOY40FB
-

LEXUS

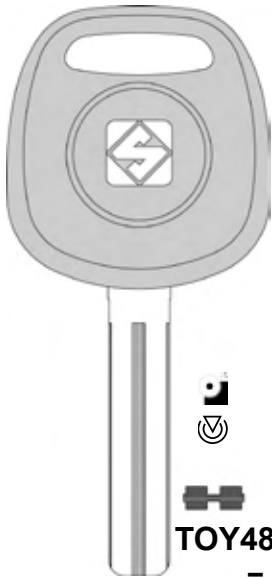

ILCO
EZ

TOY48BT4
-



GTH
(Head Only)

EB3-F-TOY48
(Blade Only)

TOY48-GTK
(Complete Key)

LEXUS



ILCO
EZ

TOY48-GTS
-



TOY48-FB
-



LEXUS



TOY50-PT
-



LX40
-



LX80
-

ILCO
EZ

VEHICLE KEYS

LINCOLN

LLOYD

SEE
FORD

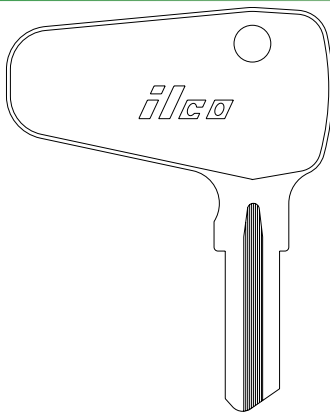

BH1
-

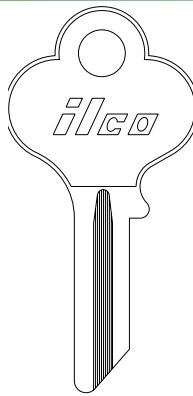

FV1
-

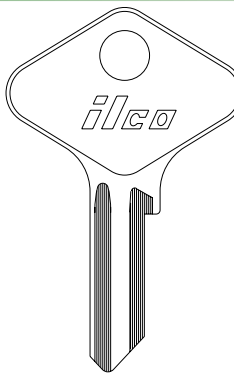

DM3
-

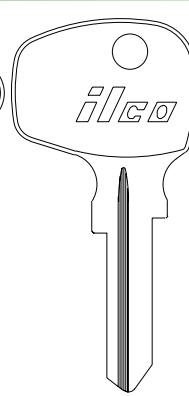

MB5
-

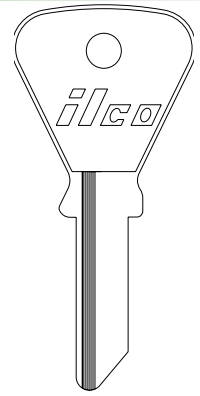

62VH
- ILCO
EZ

LLOYD



S62VP
-

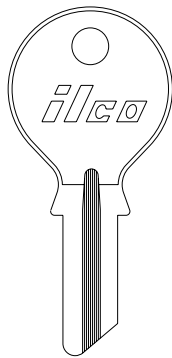

63
-

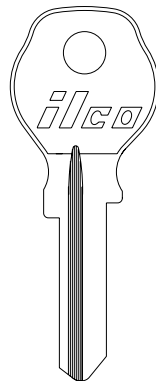

M63BG
-

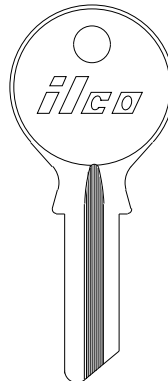

63L
-

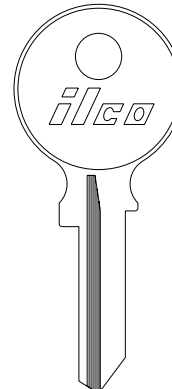

M63B
-

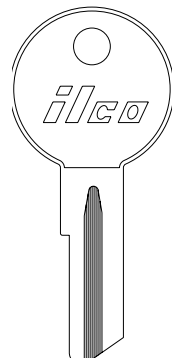

XD63
- ILCO
EZ

SEC
1
PG
140





LLOYD

LOWE & FLETCHER

MACK

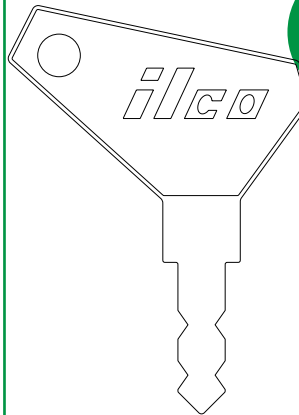
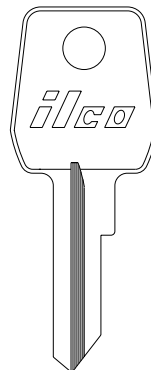
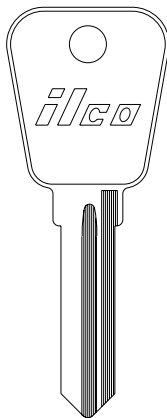
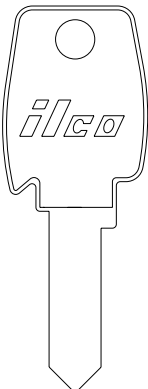
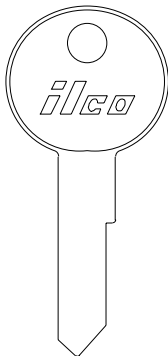
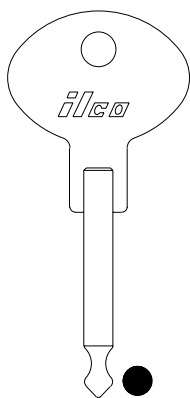

ILCO 138
EZ -

LF5
-

LF7
-

LF8
-

LF24
-

L194
-

DAV10
-

MACK

MAGIRUS-DEUTZ

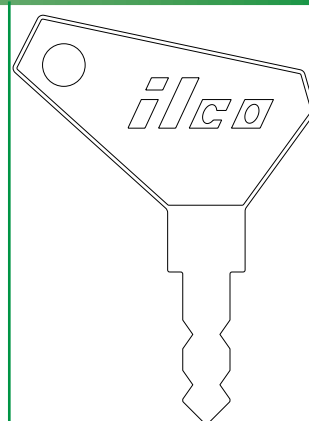
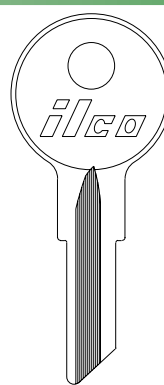
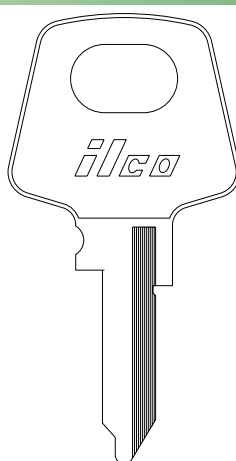
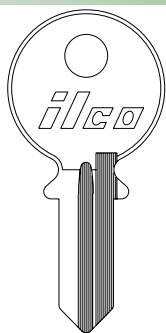
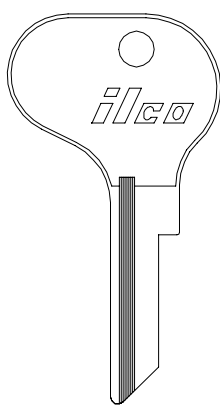

ILCO NE10
EZ -

R62UC
-

X163
BL11

1098M
B1

DAV10
-

MAGIRUS-DEUTZ

MAGNETI-MARELLI

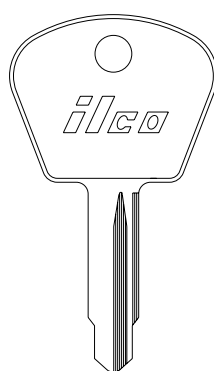
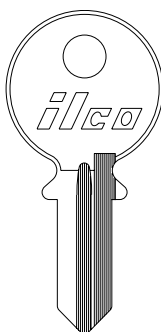
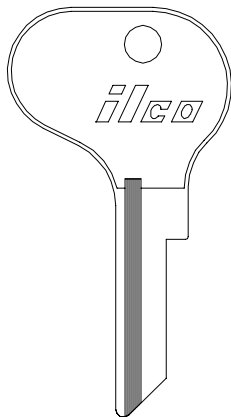

SP3
-
SP4
-

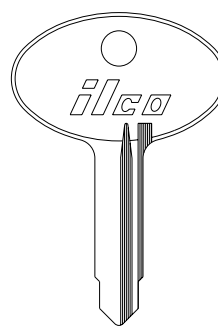

R61D
-
R61TS
-

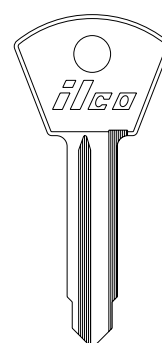

ILCO NE10
EZ -

R62UC
-

SP2
-

61D
-

61F
-





VEHICLE KEYS

SEC 1
PG 142

MAGNETI-MARELLI

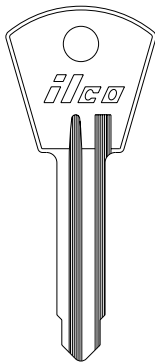

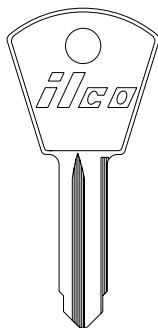

L61D
-

LR61D
-

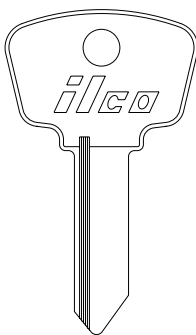

63ST



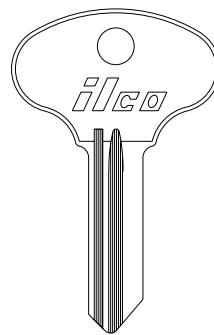

R63ST

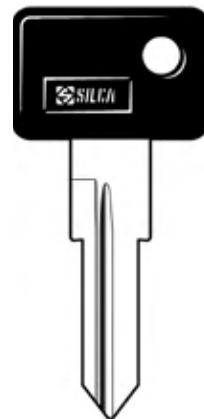

R63SP

MALAGUTI



ZD16RP-SI
-
ILCO
EZ

H61G
-

F91GS
-

MALAGUTI



ZD23RCP-SI
-



ZD23RT5
-

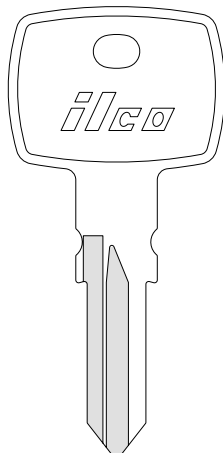

X270
TMC1

MASERATI

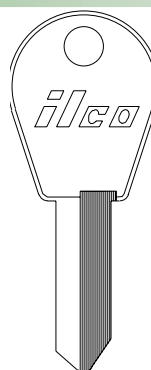

MAS1
-

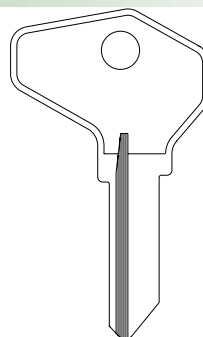

SF3-SI
-
ILCO
EZ

MASERATI

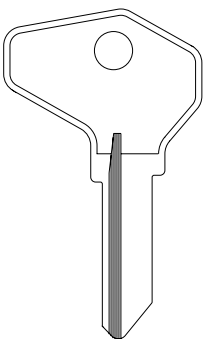

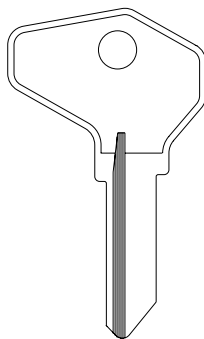

SF4-SI
-



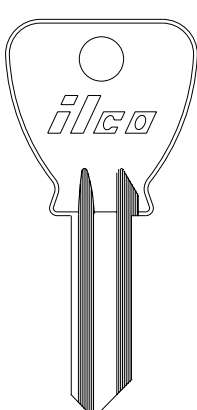

SF5-SI
-

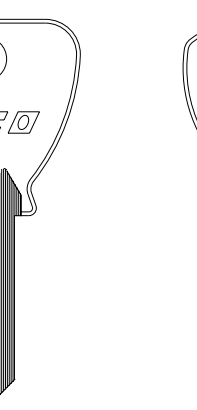



BO2
-

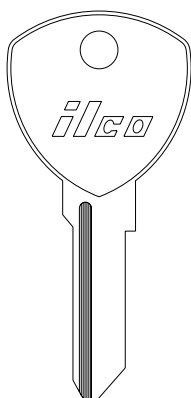

BO6
-

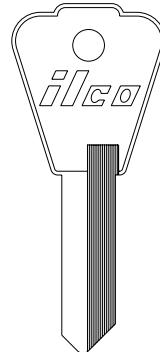

GT3
-





LN4
-

ILCO
EZ

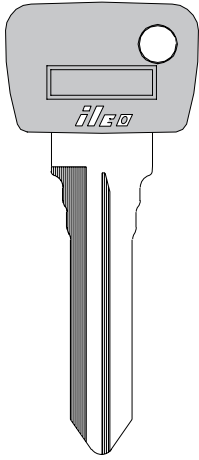

MAZDA



ILCO
EZ

MZ9-P
-

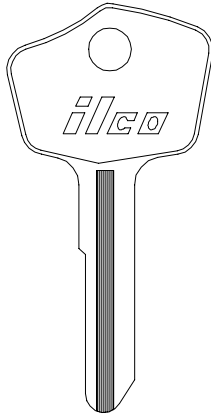

MZ10-P
-

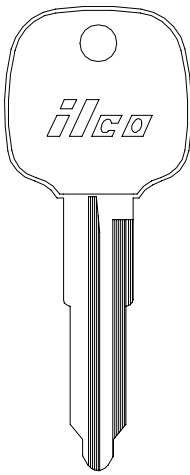

X36
MZ11



X60
MZ14

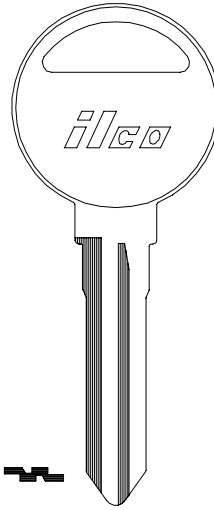

X131
MZ13

MZ13R
-

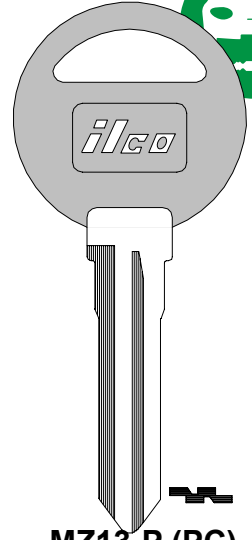

MZ13-P (PC)
-

MAZDA

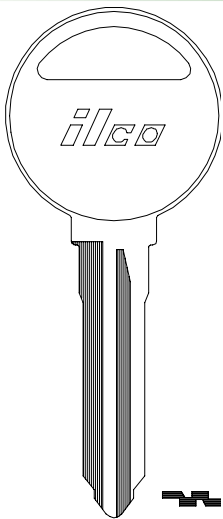

ILCO
EZ

X178
MZ16

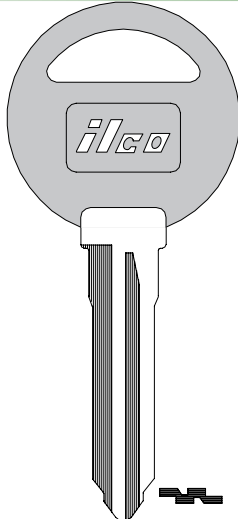

MZ16-P
-

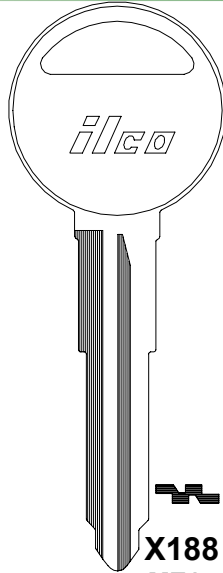

X188
MZ17

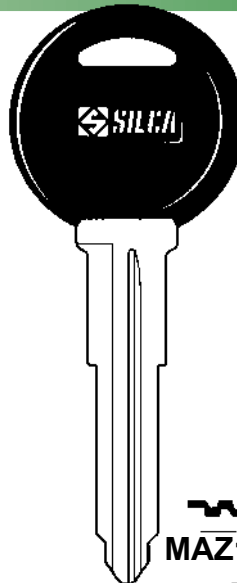

MAZ13AP
-

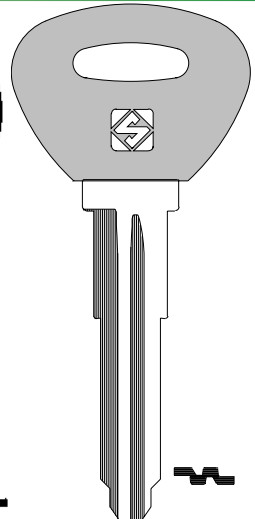

MAZ13EP
-

MAZDA

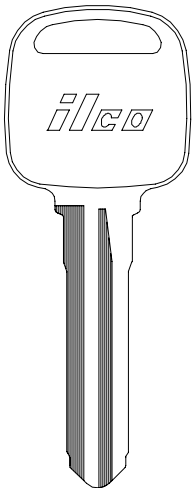

ILCO
EZ

X199
MZ20

VALET FOR X131 & X178

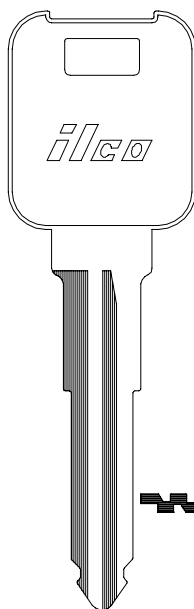

X201
MZ19

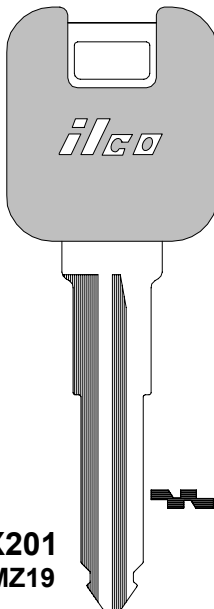

MZ19-P (-PC)
-

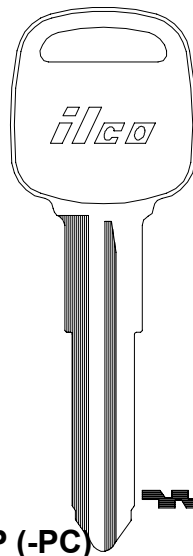

VALET FOR X201/MZ19

X200
MZ22

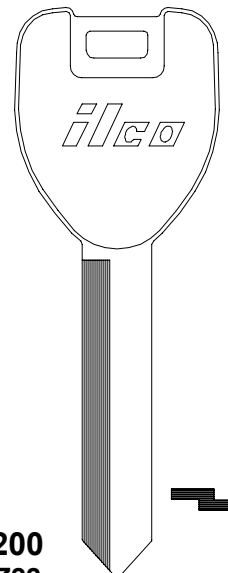

X206
MZ25





MASERATI

MATADOR

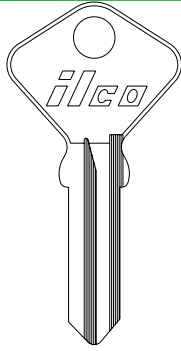
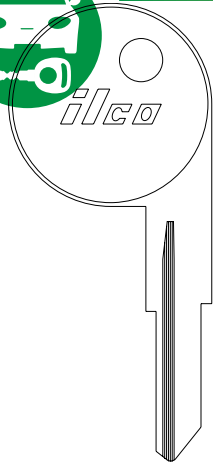

F91CR
-
F91C2
-
F91C8
-

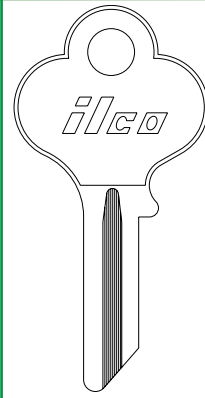
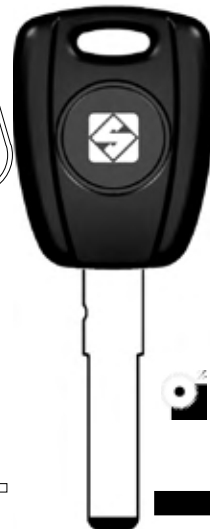
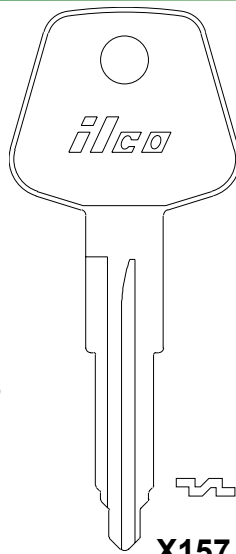

X64
SP6

X79
SP7

F91C
-

X157
LF17

SIP22-GTS
-

FV1
-

ILCO
EZ

VEHICLE KEYS

MATADOR

MAZDA

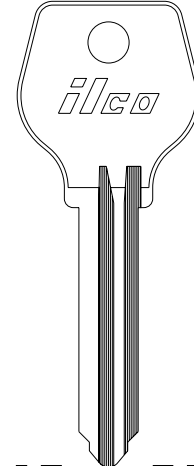
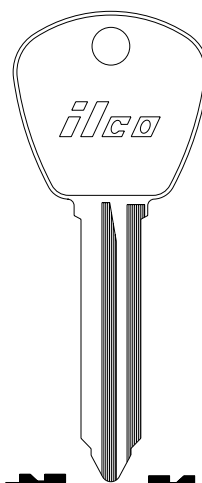
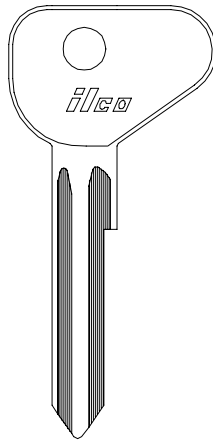
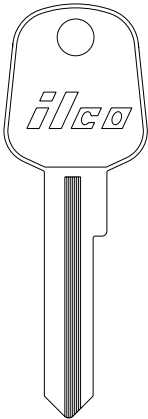
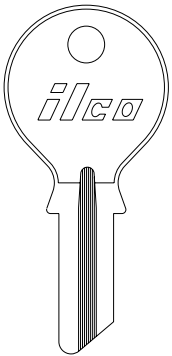

63
-

MZ1
-

X1
MZ12

X2
MZ3

X3
MZ2

X4
MZ4

X5
MZ5

ILCO
EZ

MAZDA

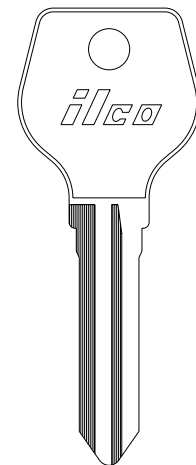
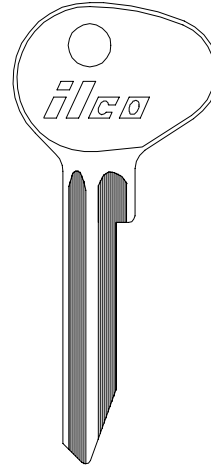
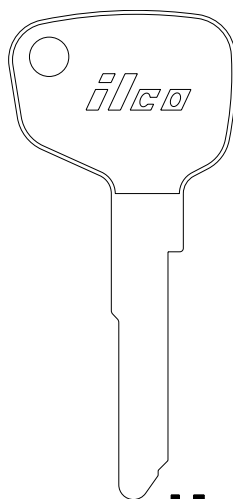
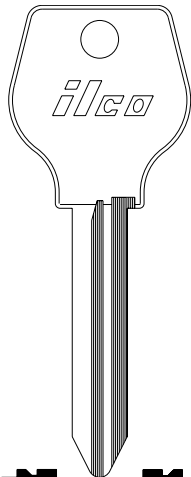
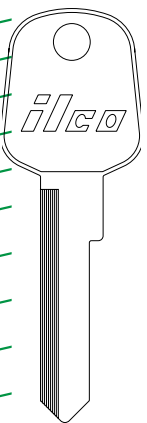

SEC 1
PG 144
MZ6
-

MZ7
-

MZ8
-

MZ15
-

DA20
-

X26
MZ9

X27
MZ10

ILCO
EZ



MAZDA

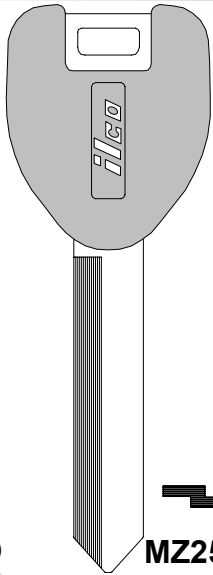

ILCO EZ MZ25-P -

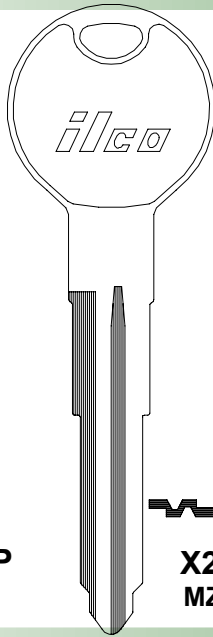

X222 MZ27

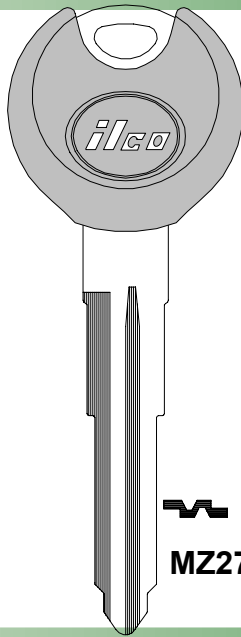

MZ27-P (-PC) -

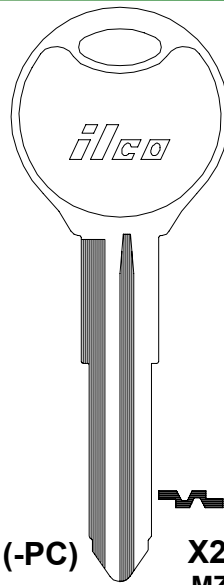

X230 MZ29

VALET FOR X222 & MZ27-P (-PC)

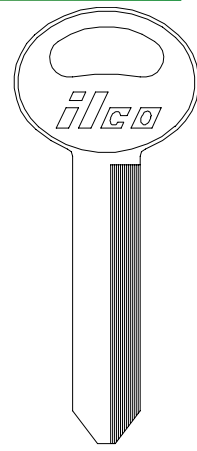

S1167FD H50

MAZDA

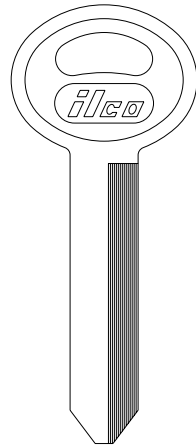

ILCO EZ H50-PC -

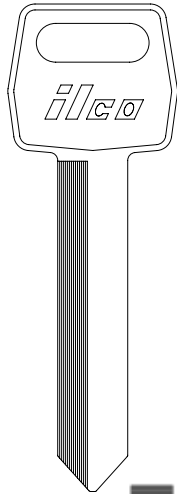

1184FD H54

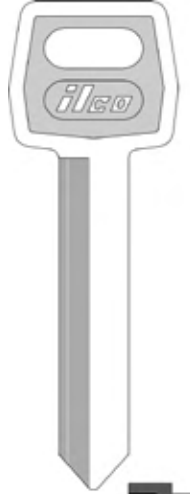

H54-PC -

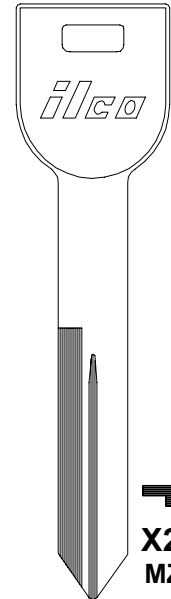

X247 MZ30

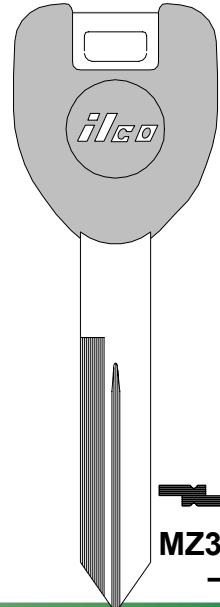

MZ30-P -

MAZDA

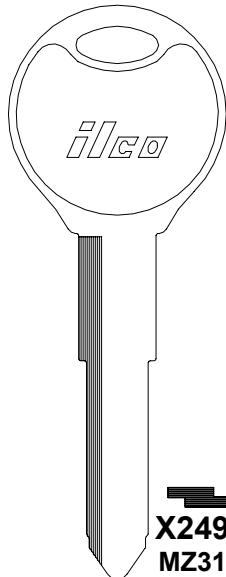

ILCO EZ X249 MZ31

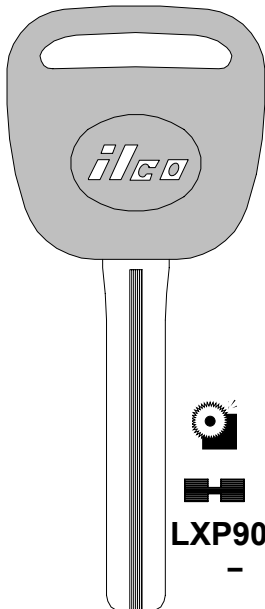

LXP90-P -

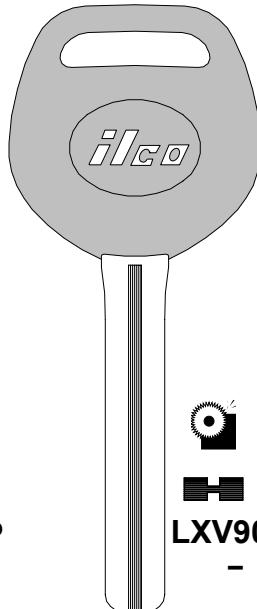

LXV90-P -

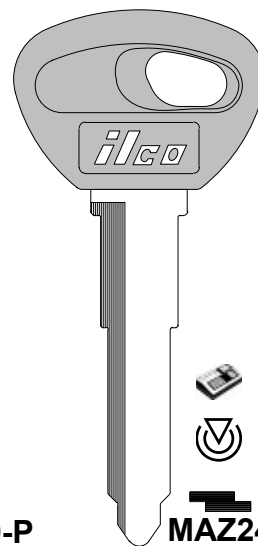

MAZ24RT5 -





MAZDA

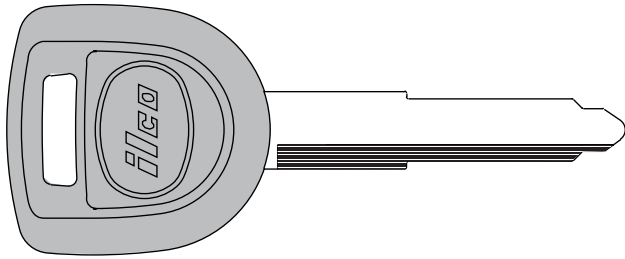

MAZ24R-PT

-

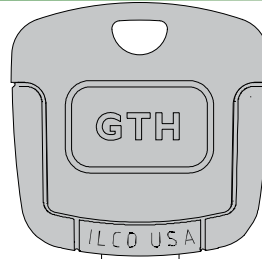

GTH
(Head Only)

EB3-J-MAZ24
(Blade Only)



MAZ24-GTK
(Complete Key)

ILCO
EZ

VEHICLE KEYS

MAZDA

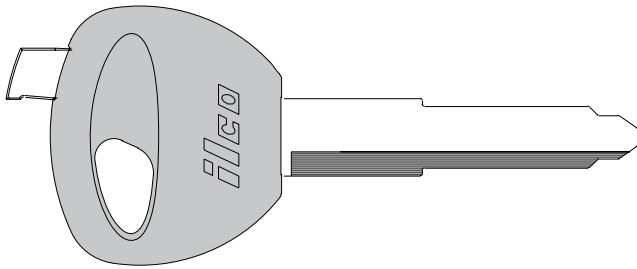

MAZ24-GTS

-



MAZ24FB

-

ILCO
EZ

MAZDA



GTH
(Head Only)

ILCO USA

B

EB3-B-H72
(Blade Only)



H72-GTK
(Complete Key)

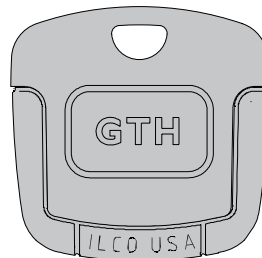

GTH
(Head Only)

ILCO USA

D

EB3-D-H84
(Blade Only)



H84-GTK
(Complete Key)

LN4
-

ILCO
EZ

MAZDA

MERCEDES BENZ

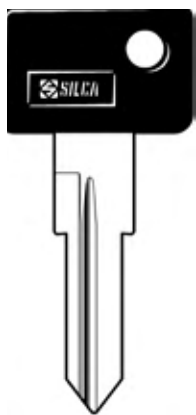

ILCO EZ ZD16RP-SI -



ZD23RT5-SI -



ZD24RDP-SI -

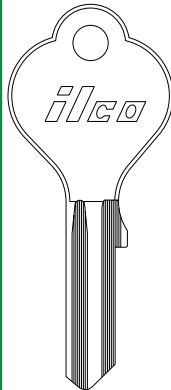

HF3 -



HF4 -
HF5 -
HF6 -

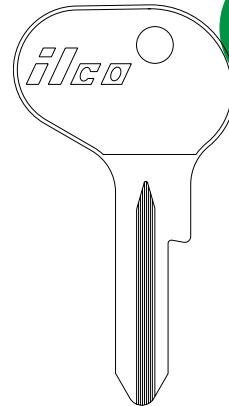

KL1 -

MERCEDES BENZ

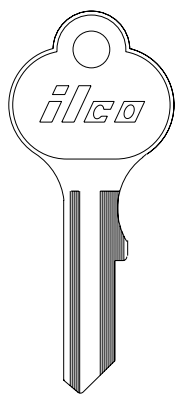

ILCO EZ VW1 -

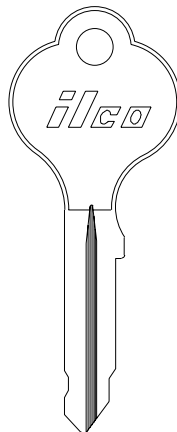

YM1 -



YM3 -
YM4 -
YM5 -

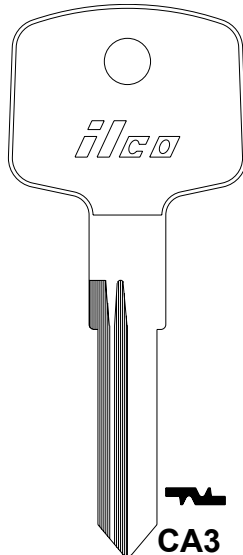

CA3 -

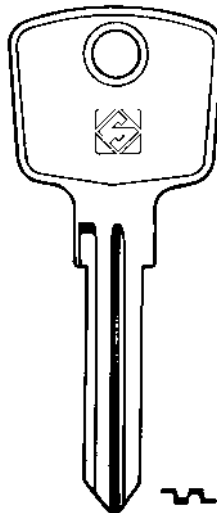

CR4R -

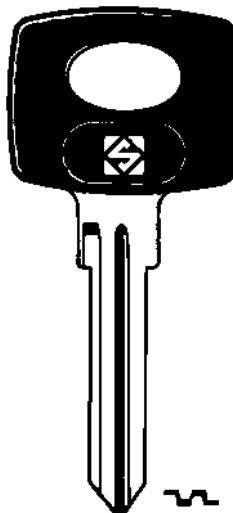

CR4RP -

MEERCEDES BENZ

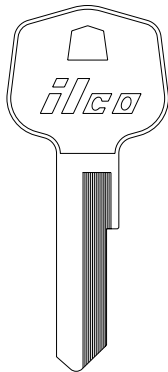

ILCO EZ HF7 -



HF9 -
HF14 -
HF15 -
HF16 -

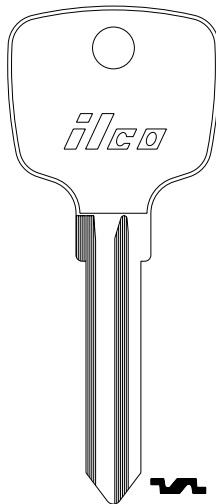

MB18 -



MB16 -
MB16R -
MB17 -
MB15 -

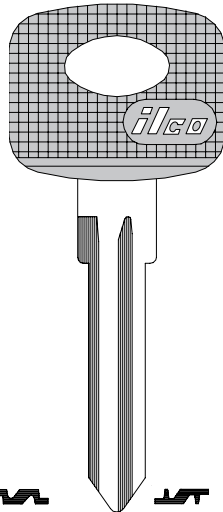

MB15-P -



MB18-P -

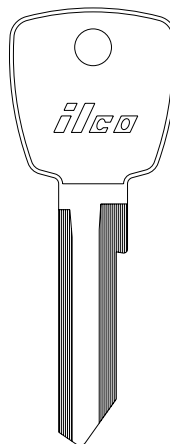

YM16 -





MERCEDES BENZ

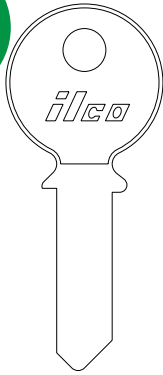

MB20

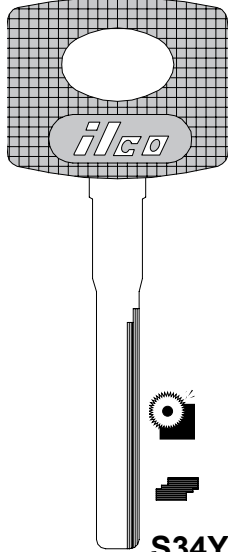

S34YS-P
VALET FOR S34YS-P

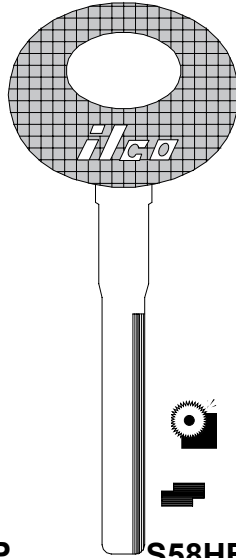

S58HF-P

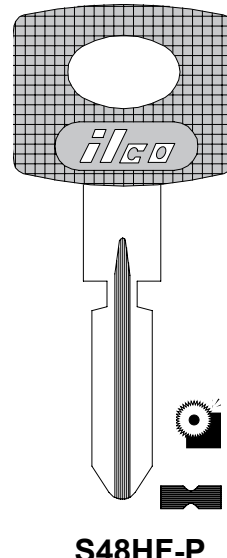

S48HF-P

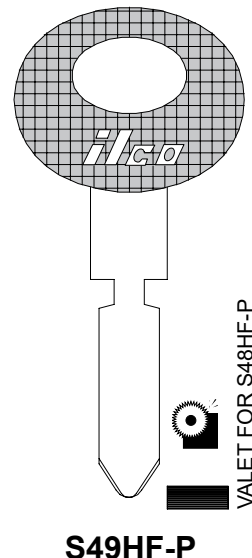

S49HF-P
VALET FOR S48HF-P
ILCO
EZ

MERCEDES BENZ

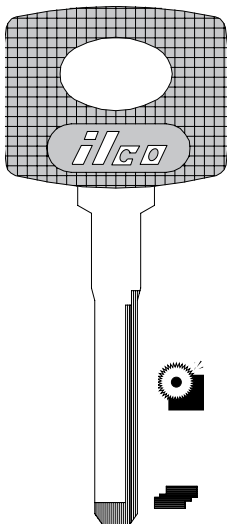

S50HF-P

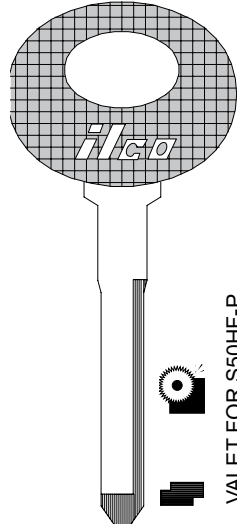

S53HF-P
VALET FOR S50HF-P

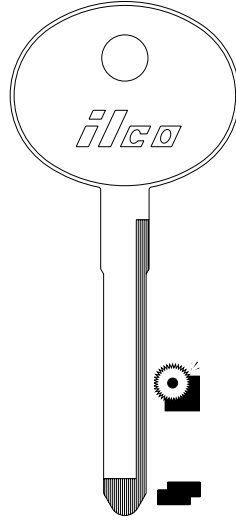

HF57

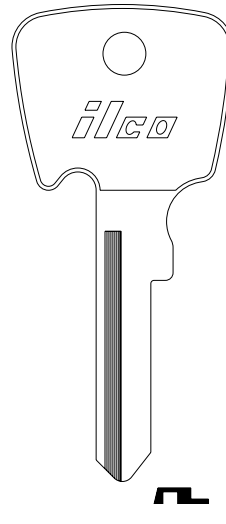

MB59
M68

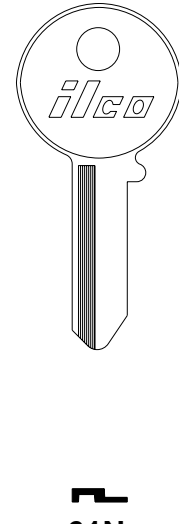

61N

61NA
-
R61NA
-

ILCO
EZ

MERCEDES BENZ

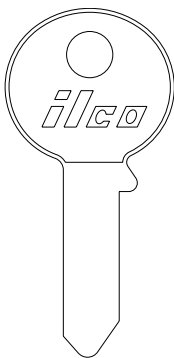

61NC

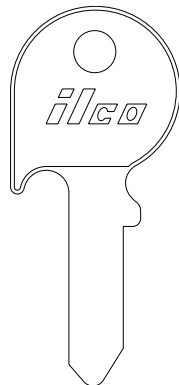

H61NA

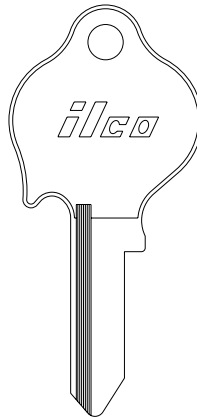

HR61NA

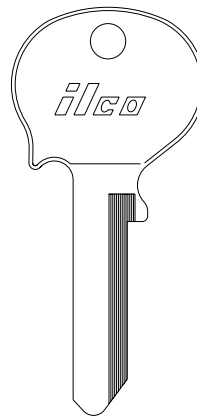

H61VM



H61VR

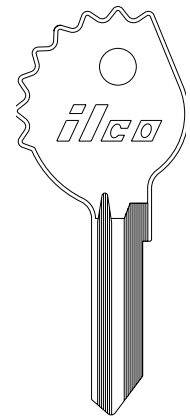

62VA

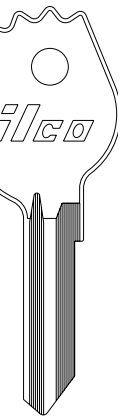

62VJ
-
ILCO
EZ

VEHICLE KEYS



MERCEDES BENZ

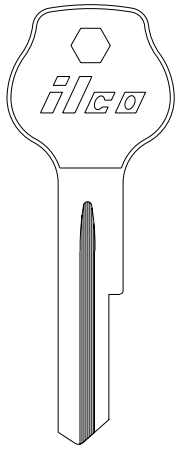

63K
-

R63K
-

63W
-

R63W
-

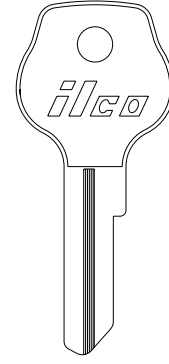
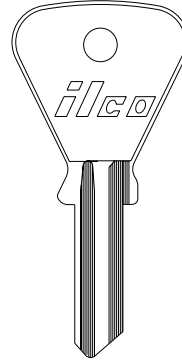
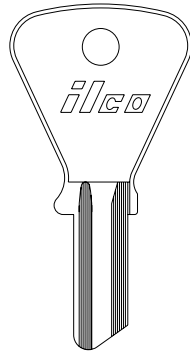

ILCO **A62VN**
EZ -



B62G
-



H62VG **HR62VG**
- -



R62VA **R62VN**
- -



MERCEDES BENZ

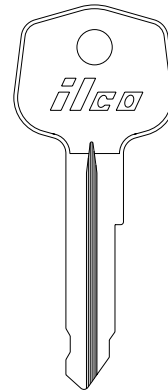
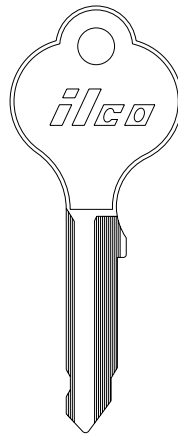
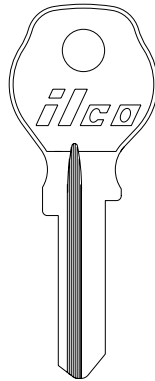
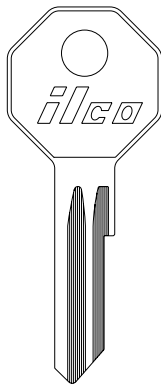
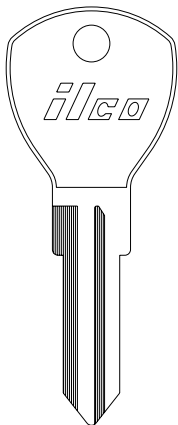

63TVK
-

63TW
-



M63E
-



MR63E
-



ILCO **S62FD**
EZ -



63A
-



M63BG
-



63C
-



63E
-

MERCEDES BENZ

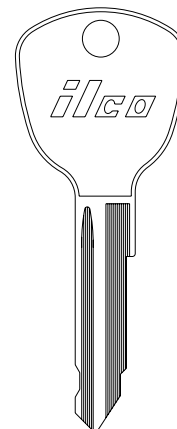
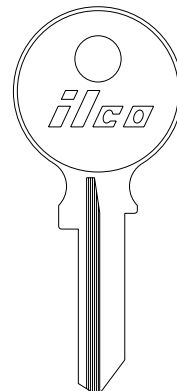
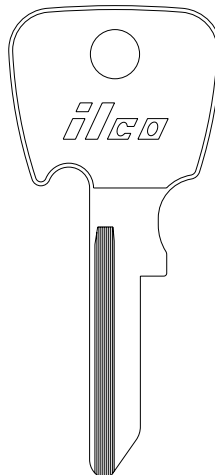
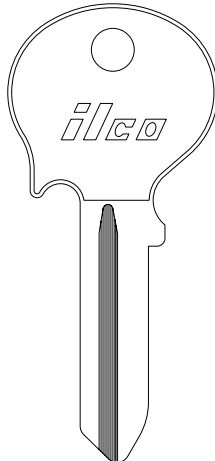
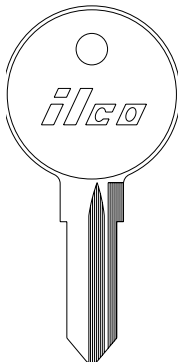

ILCO **63H**
EZ -



63JA
-



H63M
-



M63B
-



R63KE
-



U63H
-





MERCEDES BENZ

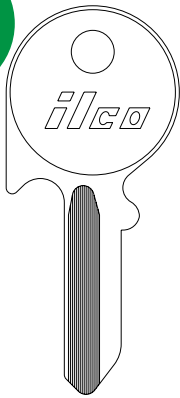

65K

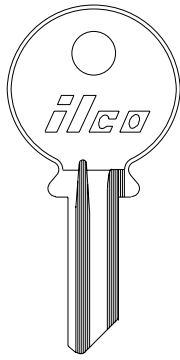

F65

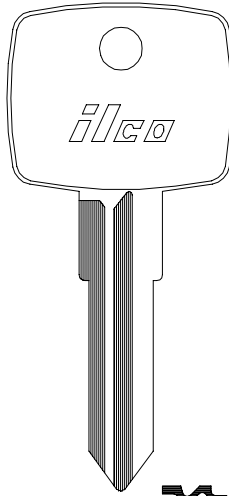

X82
MB41

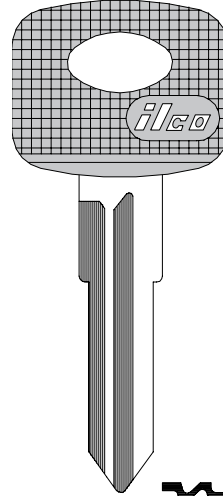

MB41-P

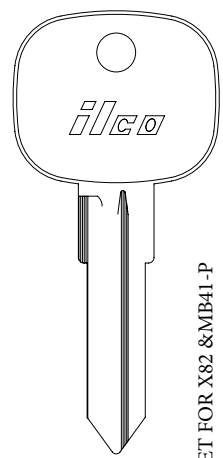

MB38

VALET FOR X82 & MB41-P

ILCO
EZ

VEHICLE KEYS

MERCEDES BENZ

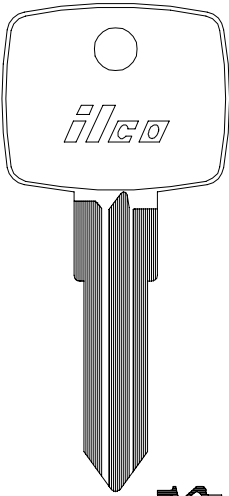

X83
MB39

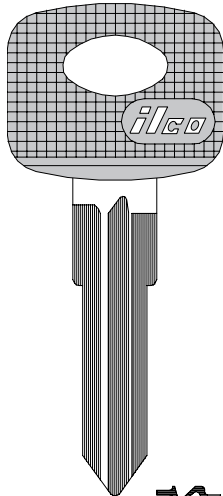

MB39-P

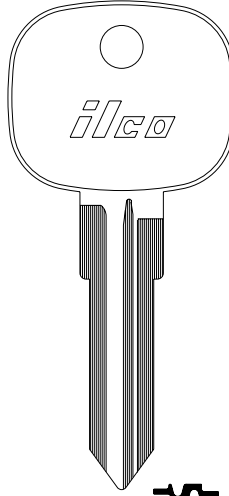

MB40

VALET FOR X83 & MB39-P

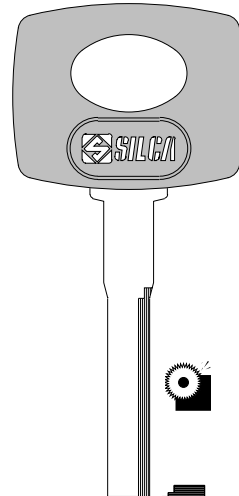

HU64P-SI

ILCO
EZ

MAZDA

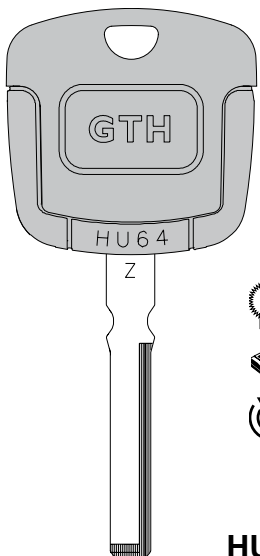

HU64-GTK
(Complete Key)

GTH
(Head Only)

EB3-Z-HU64
(Blade Only)

MERCURY

SEE
FORD

MERCURY/MARINER OUTBOARDS



1040



1040A

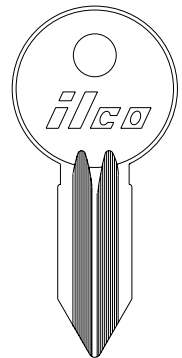

1040B

ILCO
EZ

MERCURY/MARINER OUTBOARDS

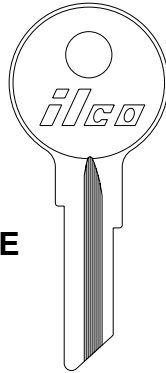
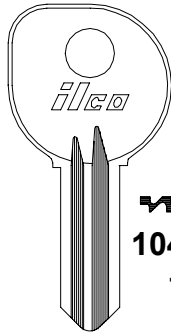
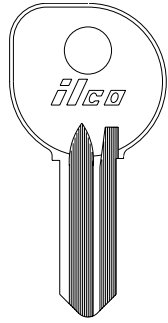

CU9
-



CU10
-

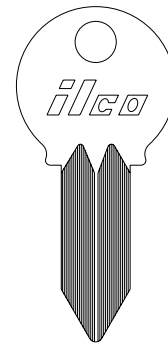

1262A
-

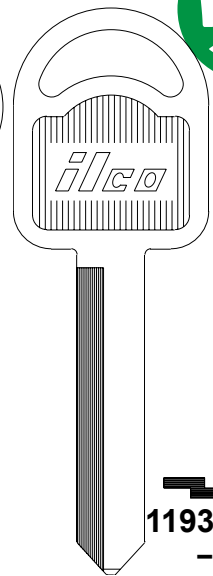

1193MU
-



1040E
-



1040U
-

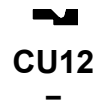

CU12
-



ILCO 1040C R1040C
EZ - -



R1040E
-



CU7
-



CU8
-

MERKUR

MESSERSCHMIDT

MG

MISC. SWITCHES

SEE
FORD
INTERNATIONAL

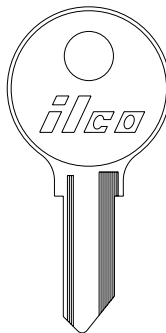

ILCO 62VA
EZ -

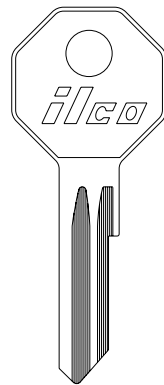

63A
-

SEE
BRITISH
LEYLAND

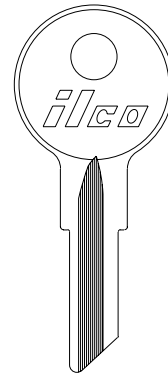

1098M
B1

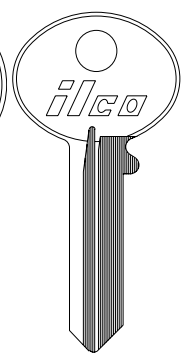

L1003M
-

MISC. SWITCHES

MITSUBISHI

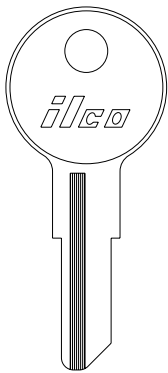

ILCO 1043B
EZ IL9

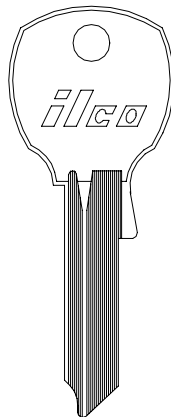

1069LB
NA12

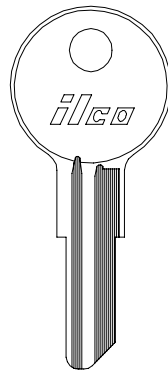

O1122
Y11

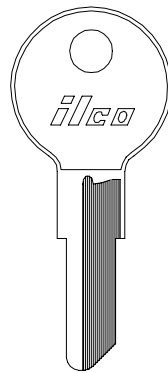

O1122AR
Y14

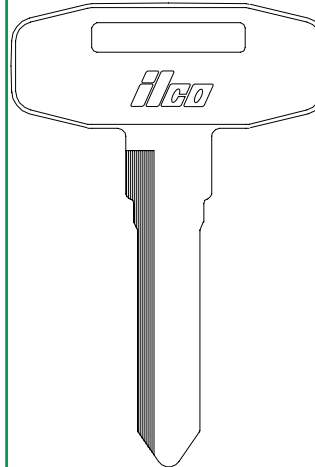

FU2
-

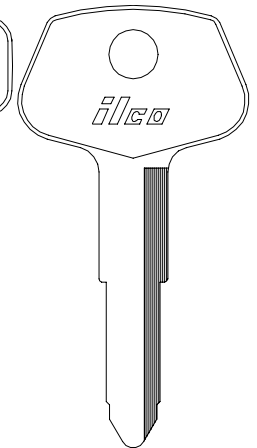

X54
DC1





MITSUBISHI

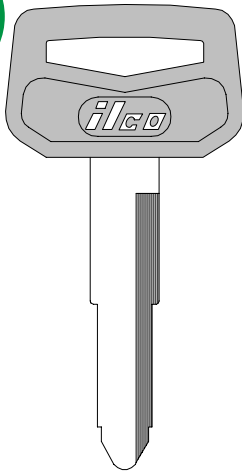

DC1-P
-

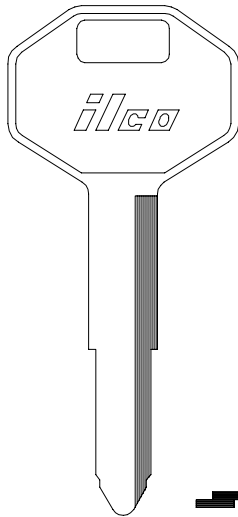

X121
DC3

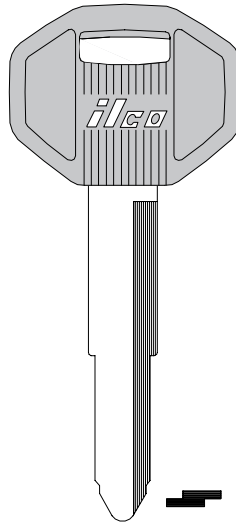

DC3-P (-PC)
-

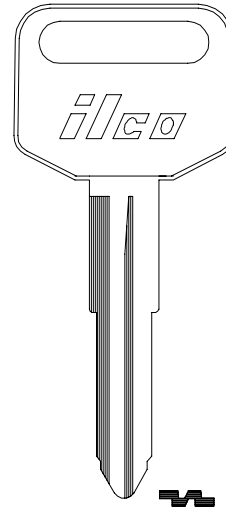

X160
HY2

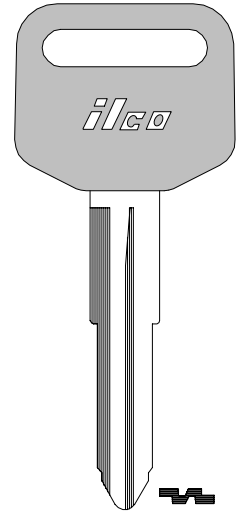

HY2-P
- ILCO
EZ

VEHICLE KEYS

MITSUBISHI

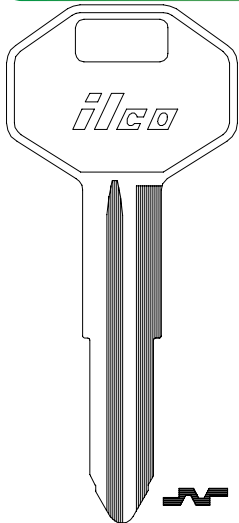

X176
MIT1

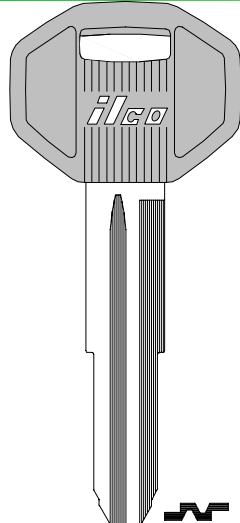

MIT1-P (-PC)
-

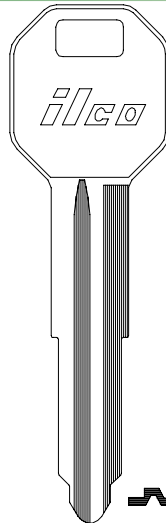

X213
MIT2

VALET FOR X176 & MIT1-P (-PC)

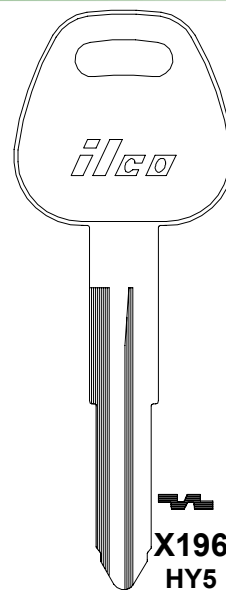

X196
HY5

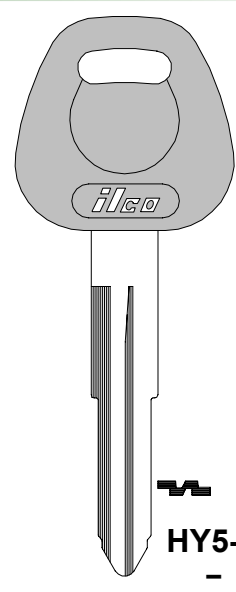

HY5-P
- ILCO
EZ

MITSUBISHI

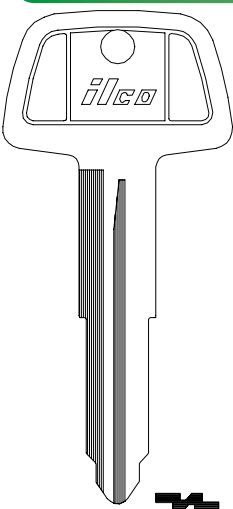

X224
MIT3

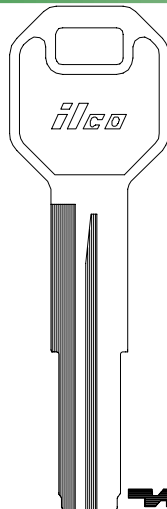

X229
MIT5

VALET FOR X224

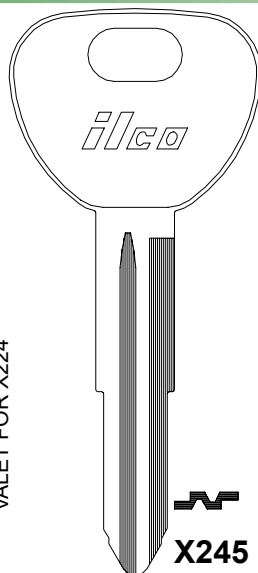

X245
MIT4

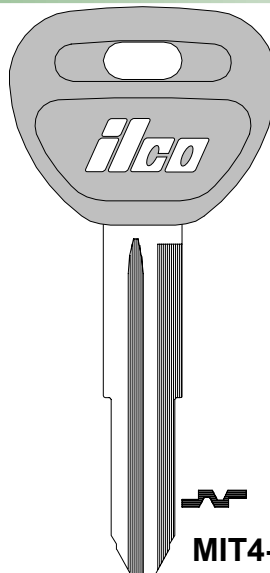

MIT4-P
-

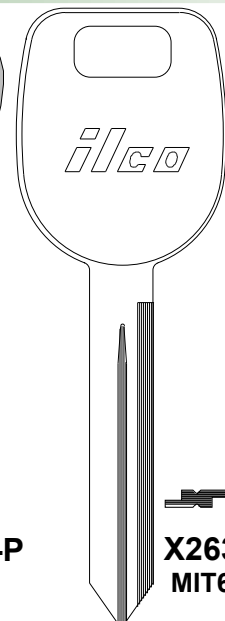

X263
MIT6 ILCO
EZ

MITSUBISHI

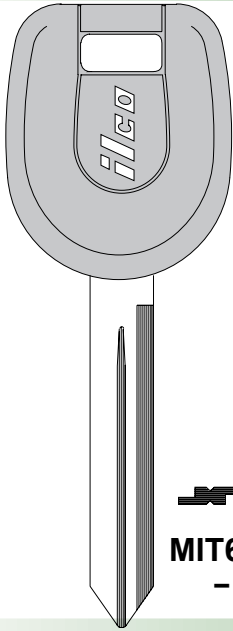

ILCO
EZ

MIT6-P
-

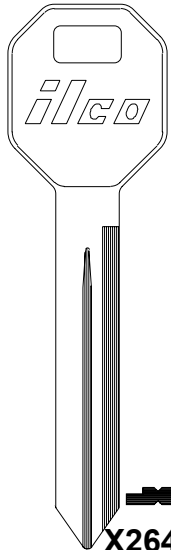

X264
MIT7

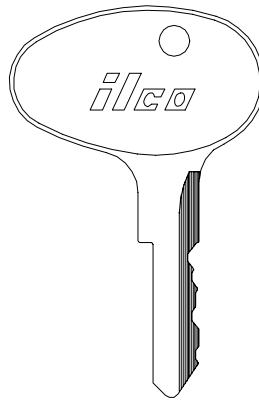

1596
-

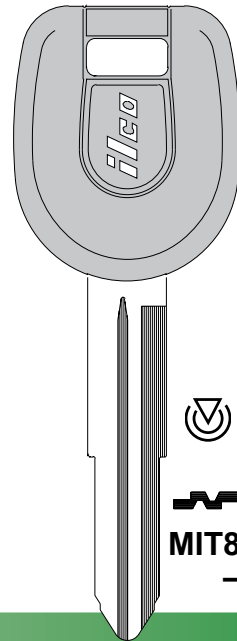

MIT8-PT
-

MITSUBISHI



ILCO
EZ

GTH
(Head Only)

EB3-K-MIT8
(Blade Only)

MIT8-GTK
(Complete Key)



MIT8TE-GTS
-

MITSUBISHI

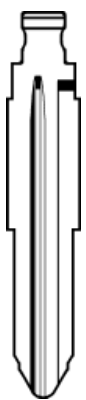

ILCO
EZ

MIT8FB
-

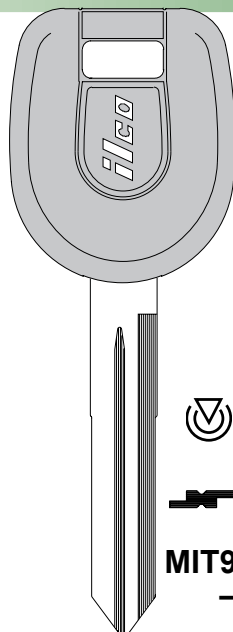

MIT9-PT
-

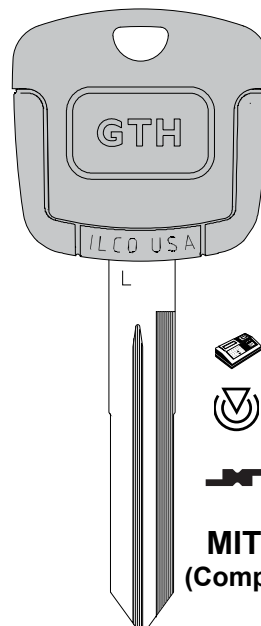

GTH
(Head Only)

EB3-L-MIT9
(Blade Only)

MIT9-GTK
(Complete Key)

VEHICLE KEYS





MITSUBISHI



MIT11RTE-GTS

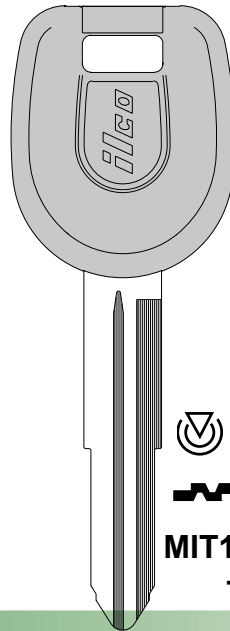

MIT12-PT

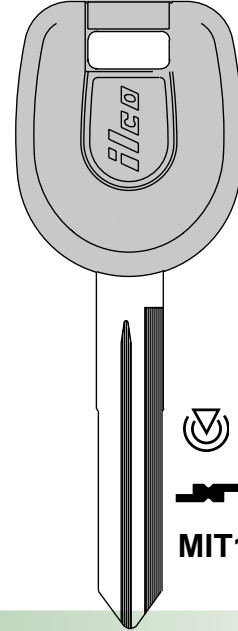

MIT13-PT

ILCO
EZ

MITSUBISHI

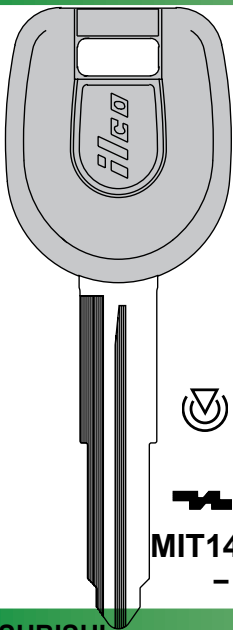

MIT14-PT

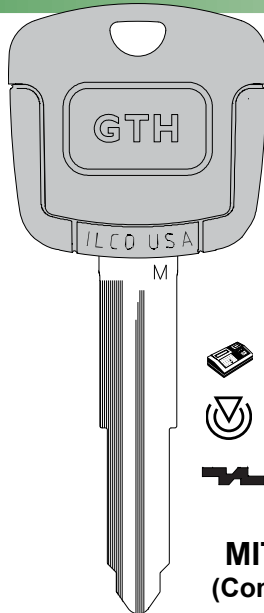

MIT14-GTK
(Complete Key)

EB3-M-MIT14
(Blade Only)

GTH
(Head Only)

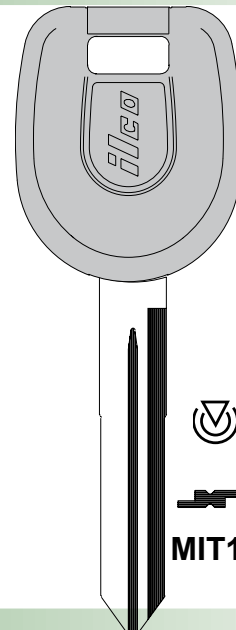

MIT16A-PT

ILCO
EZ

MITSUBISHI

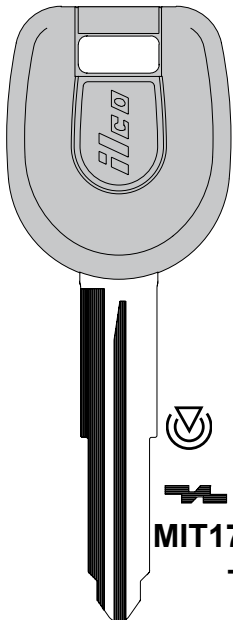

MIT17A-PT

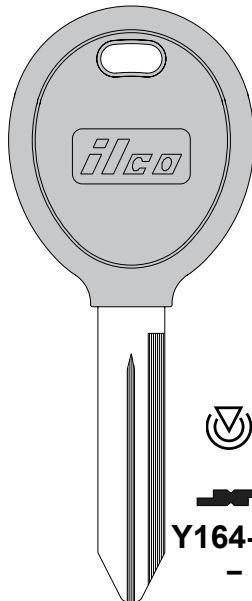

Y164-PT

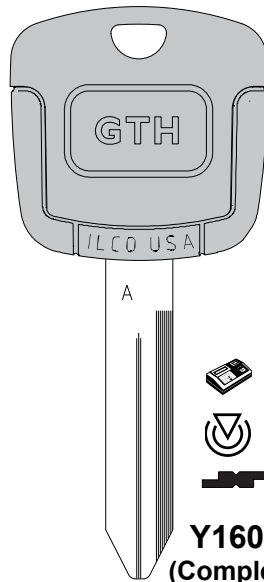

Y160-GTK
(Complete Key)

EB3-A-Y160
(Blade Only)

GTH
(Head Only)

ILCO
EZ

VEHICLE KEYS

mitsubishi

MITSUBISHI-CATERPILLAR

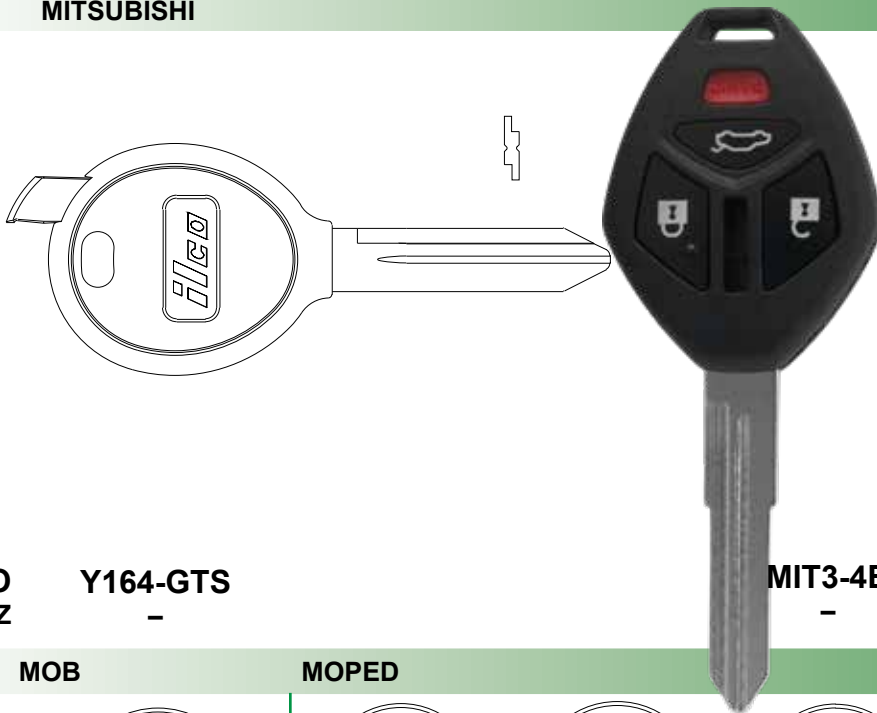

ILCO **Y164-GTS**
EZ -

MIT3-4B
-

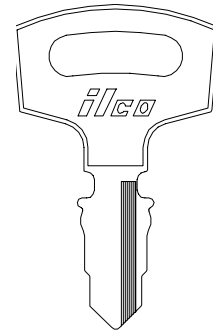

1583
-

MOB

MOPED

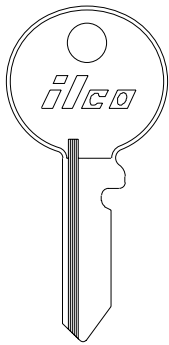

ILCO **62DP**
EZ -

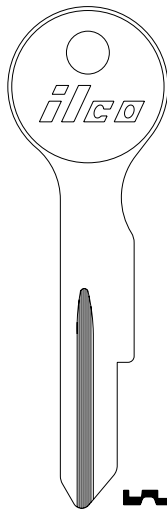

Z1
-

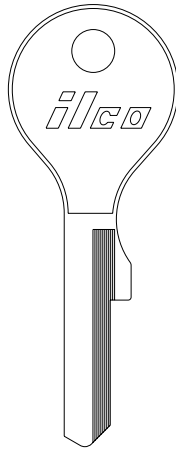

Z3H
-

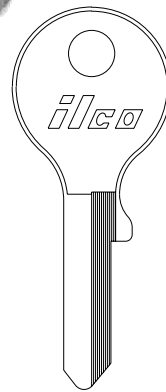

SR61N
-

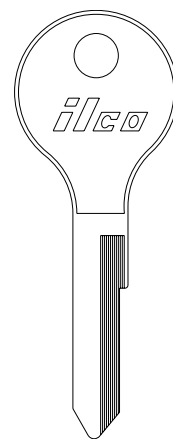

Y61
-

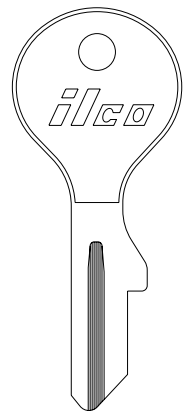

Z91
-

MORETTI

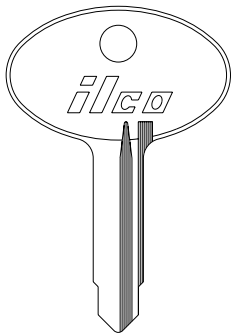

ILCO **61D**
EZ -

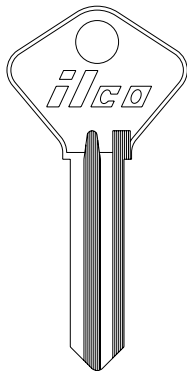

R61G
-

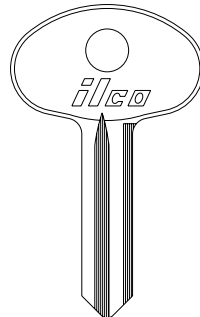

65FA **R65FA**
-

65G
-

R65G
-

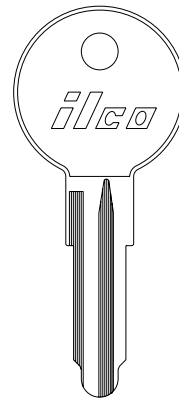

66A
-

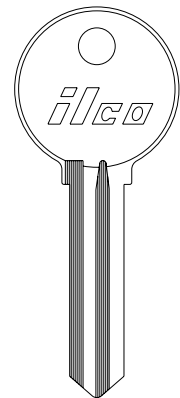

66BB
-



MORGAN

MOTO GUZZI

SEE
BRITISH
LEYLAND

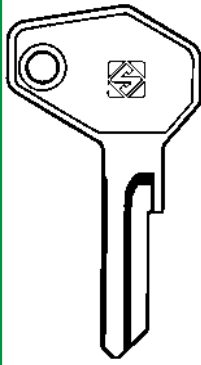

ZD7-SI
-

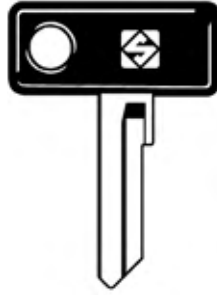

ZD9P-SI
-



ZD24RDP-SI
-

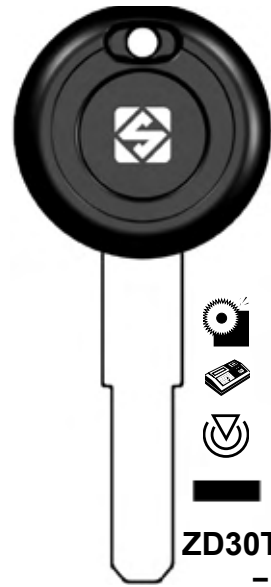

ZD30T5-SI
- ILCO
EZ

VEHICLE KEYS

MOTO GUZZI

MV

MZ

N. S. U.

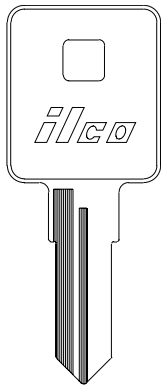

X234
HYD13



X270
TMC1

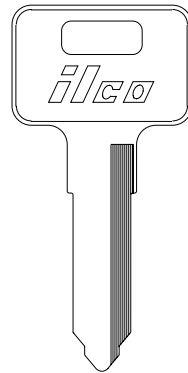

X259
-



X270
TMC1

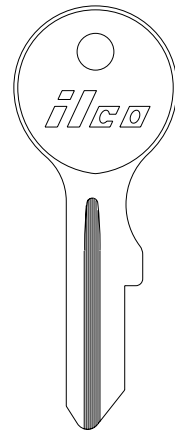

NE1
-

ILCO
EZ

N. S. U

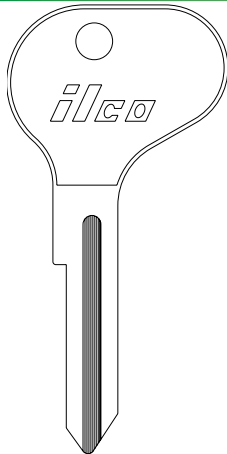

HF18
-

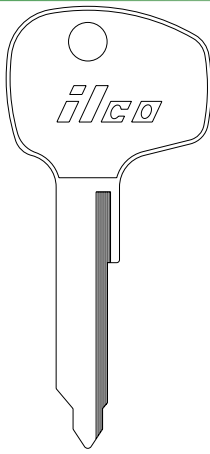

HF26
-

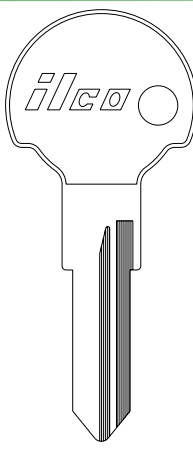

HF29
-

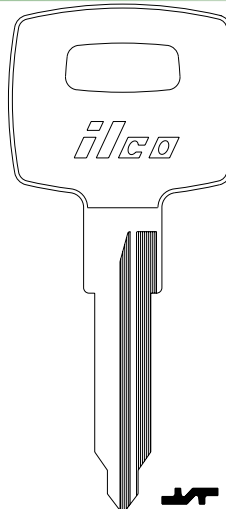

HF37
-

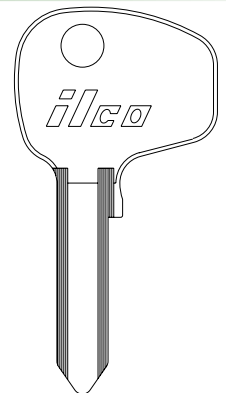

63VO
-

ILCO
EZ

SEC
1
PG
156



N. S. U.

NISSAN

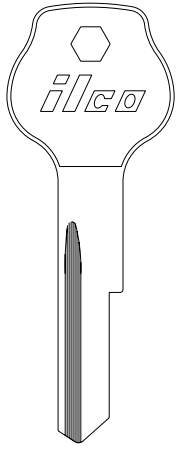

ILCO
EZ

63Y
-

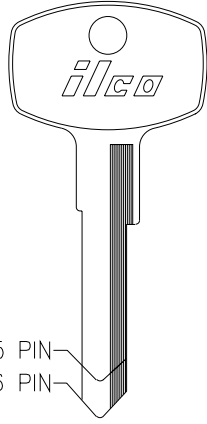

5 PIN
6 PIN



5 PIN 6 PIN
DT1 DT6
- -

5 PIN 6 PIN

DT5 DT4
- -
D72Z DT7
- -
D72D DT8
- -

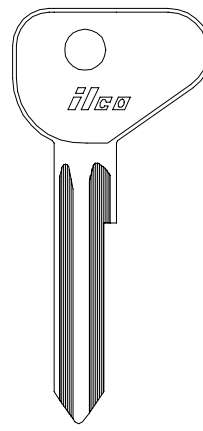

X1
MZ12

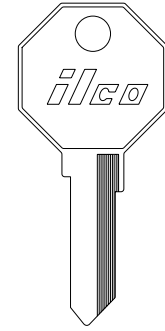

DT2
-



DT3



VEHICLE KEYS

NISSAN

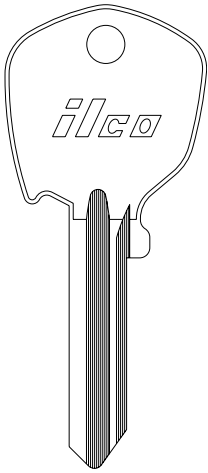

ILCO FT6 FT6R
EZ - F81E

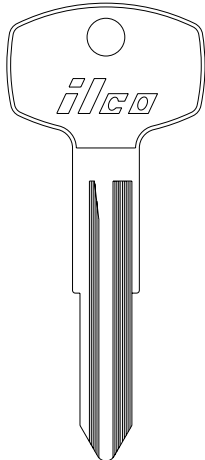

X6 X7
62DT 62DU

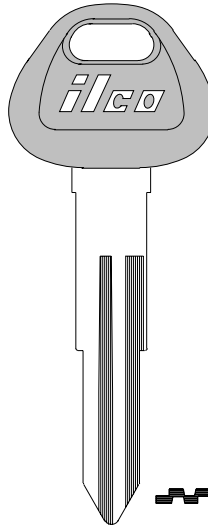

DAT6P
-

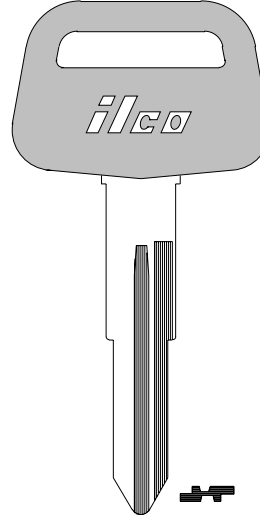

DAT6BP
-

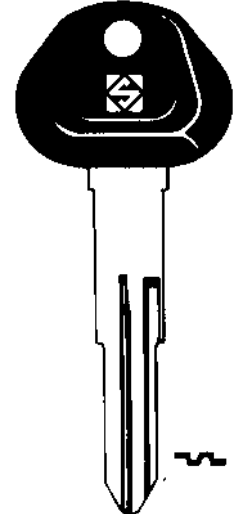

DAT6RP
-

NISSAN

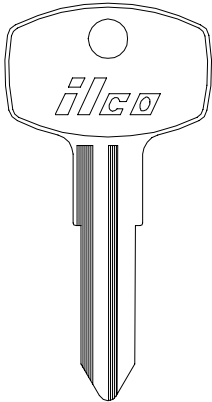

ILCO X10
EZ 62DV

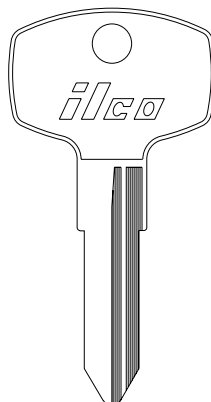

DT20
-

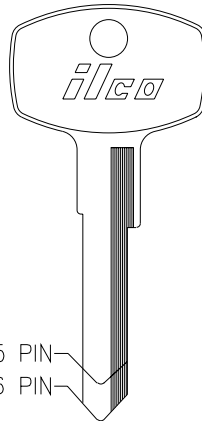

5 PIN
6 PIN



5 PIN 6 PIN
DT13 DT9
- -

5 PIN 6 PIN

DT14 DT10
- -
DT15 DT11
- -
DT16 DT12
- -

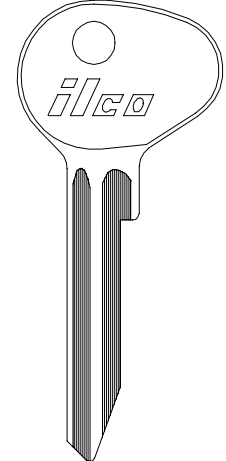

DA20
-





NISSAN

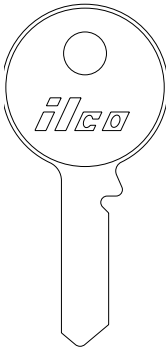

65TA
-

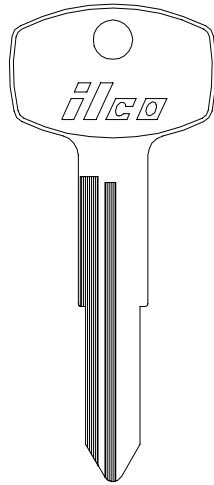

X115
DA23

X114
DA24

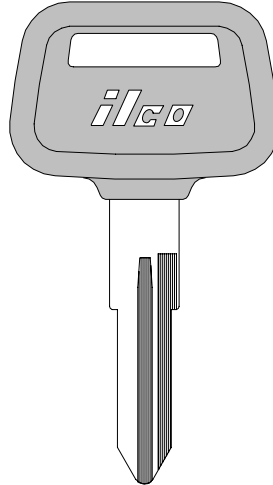

DA23-P
-

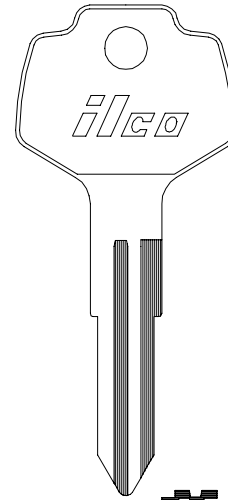

X123
DA25

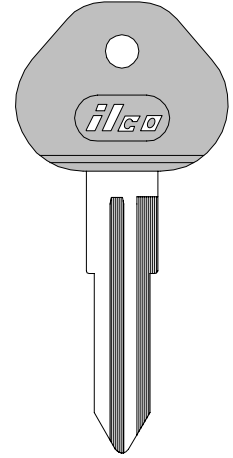

DA25-P (-PC) ILCO
EZ

VEHICLE KEYS

NISSAN

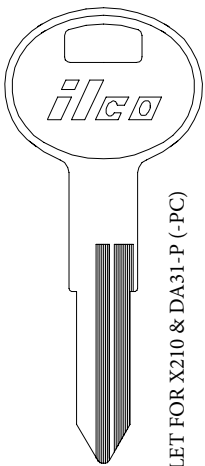

X124
DA28

VALET FOR X210 & DA31-P (-PC)

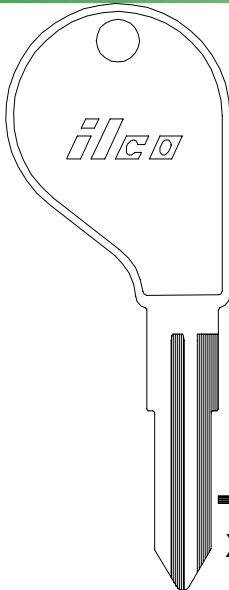

X197
DA30

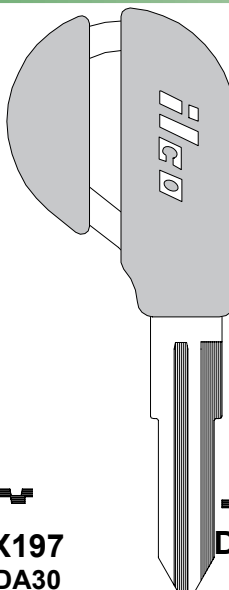

DA30-P
-

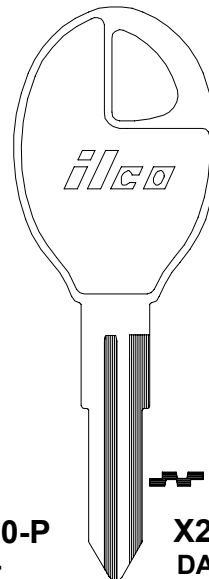

X210
DA31

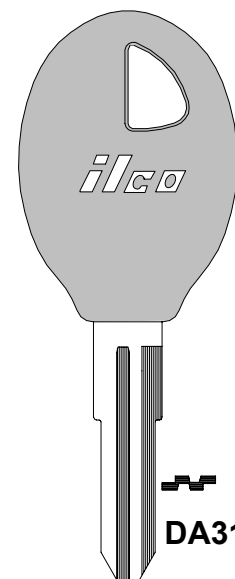

DA31-P (-PC) ILCO
EZ

NISSAN

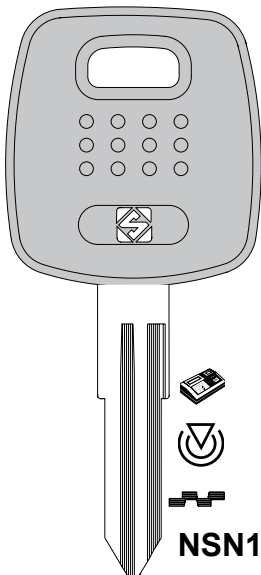

NSN11T2
-

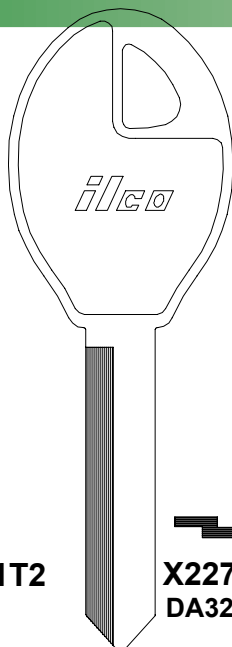

X227
DA32

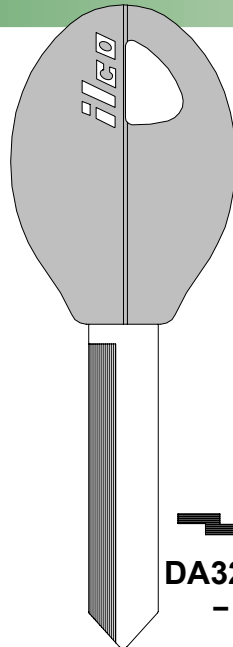

DA32-P
-

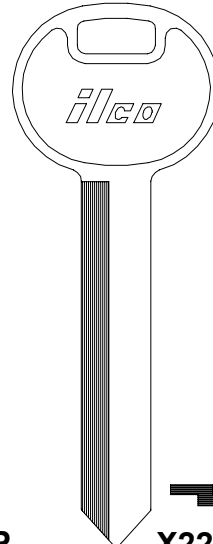

X228
DA33

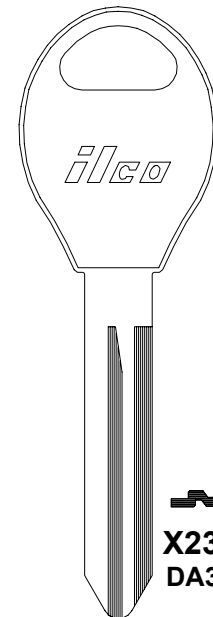

X237
DA34

ILCO
EZ



NISSAN

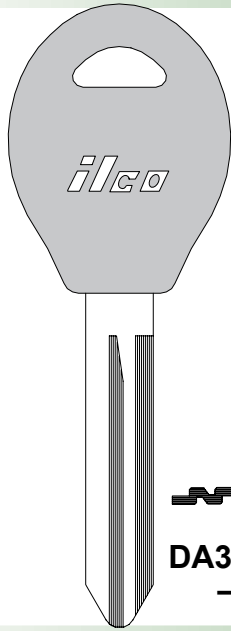

ILCO
EZ

DA34-P
-

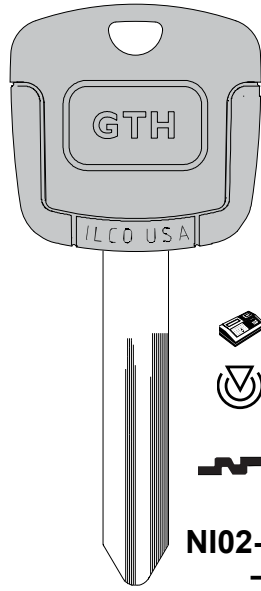

NI02-GTK
-

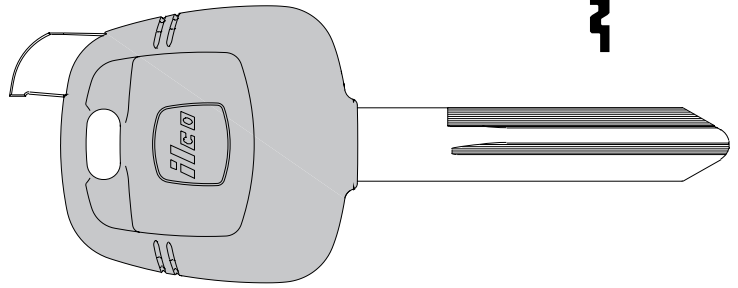

NI02-GTS
-



NISSAN

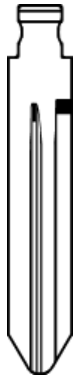

ILCO
EZ

NI01FB/NI02FB/NI04FB
-

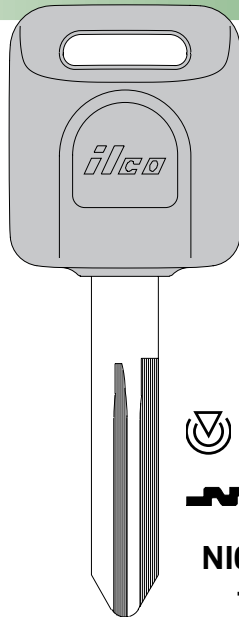

NI04T
-

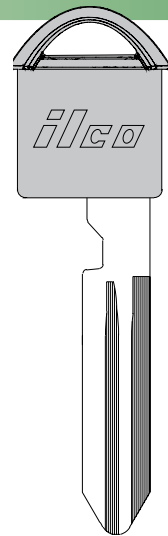

NI05T
-

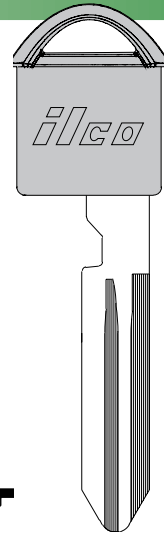

NI06-P
-

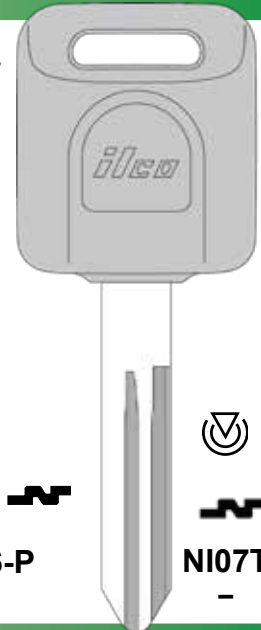

NI07T
-



VEHICLE KEYS

NISSAN

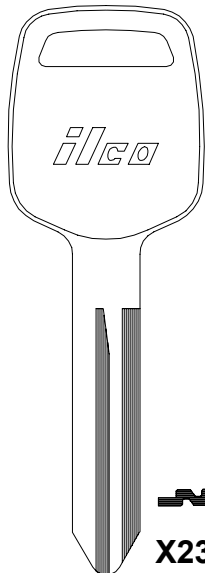

ILCO
EZ

X238
DA35



VALET FOR X237/DA34 & DA34-P

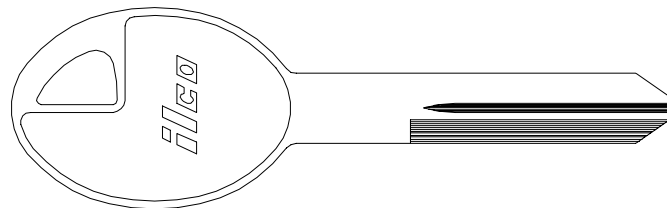

X242
DA37





NISSAN

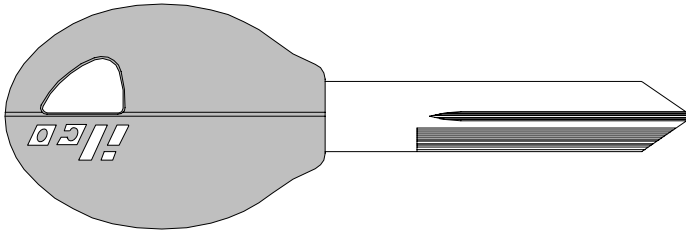

DA37-P
-

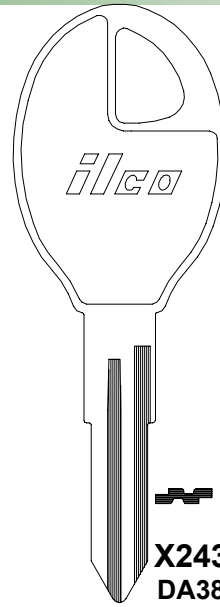

X243
DA38

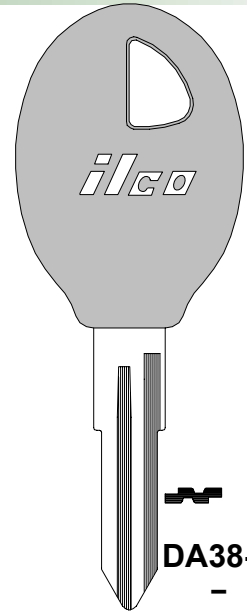

DA38-PILCO
- EZ

VEHICLE KEYS

NISSAN

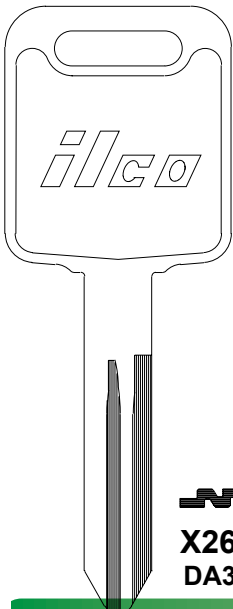

X268
DA39

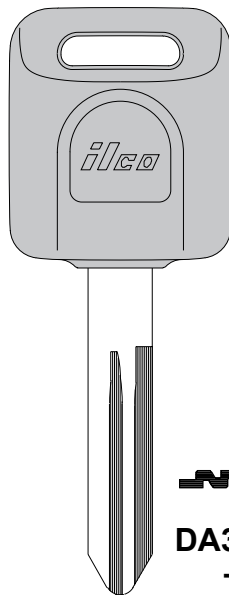

DA39-P
-

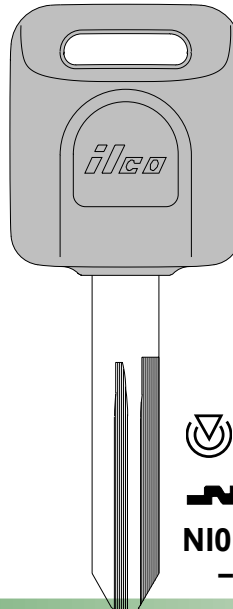

NI01T
-

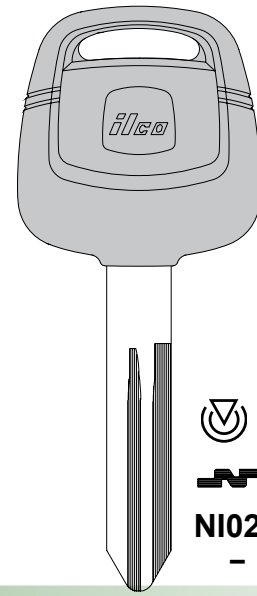

NI02T
-

ILCO
EZ

NORTON

OLDSMOBILE

OMC (JOHNSON & EVINRUDE)

OPEL



62FS
-

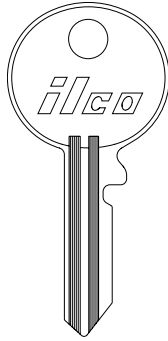

R62DM
-

SEE
GENERAL
MOTORS
(GM)

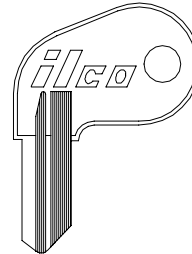

OM10
-

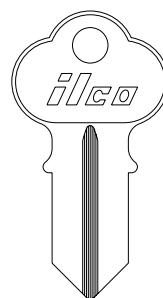

1041G
CG1

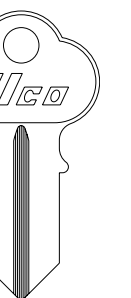

1041GA
CG2

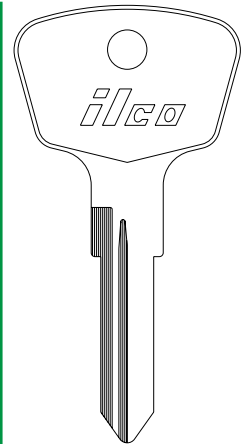

AD1
-

ILCO
EZ



OPEL

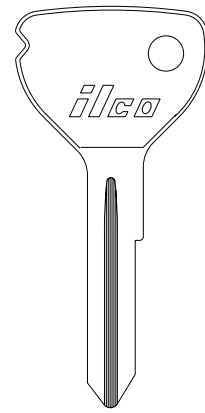
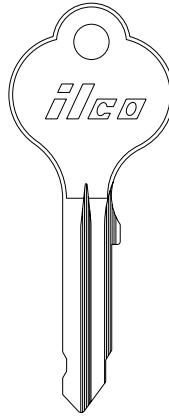
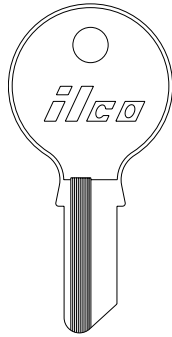
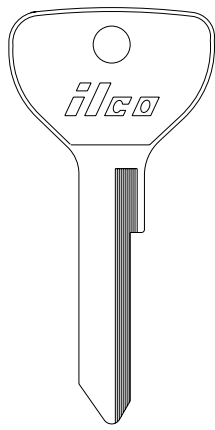
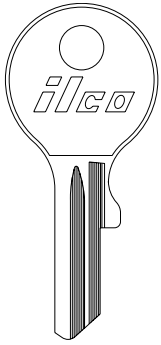

 YM7
 -
 YM8
 -
 YM9
 -



ILCO BU1 BU2
 EZ - -



OPB1
-



DK3
-



YM3
-



YM6
-

VEHICLE KEYS

OPEL

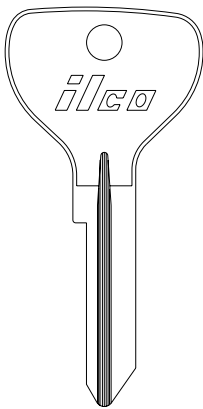

 62PD
 -
 R62PD
 -
 U62VP
 -
 UR62VP
 -
 HF21
 -

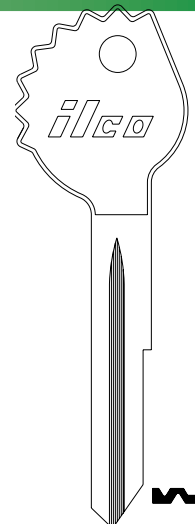
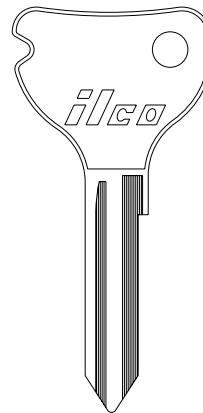
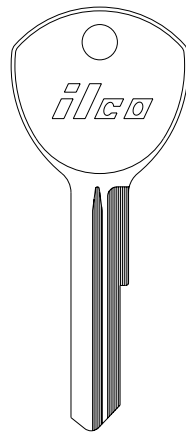

ILCO OP11 HF11
 EZ - -



HF12
-



OP12
-







OP37
-

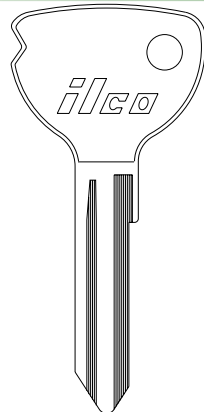
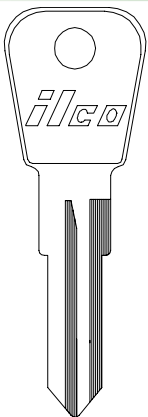

YM13
-

OPEL



 YM23
 -
 YM24
 -
 YM25
 -
 YM27
 -

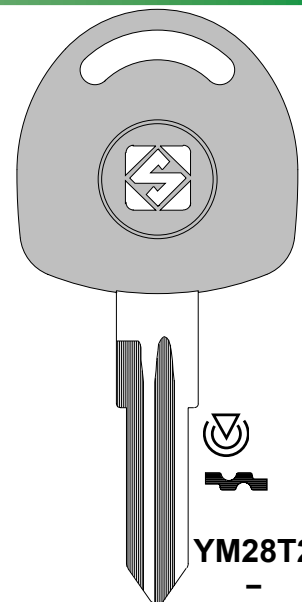
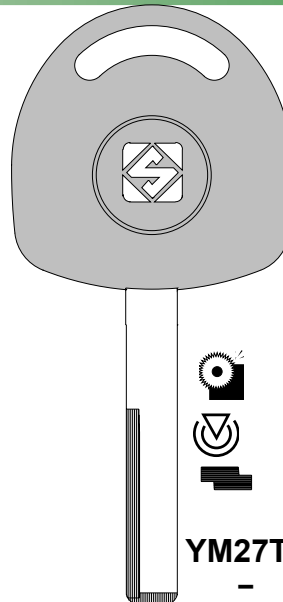

ILCO X21 X22
 EZ YS1 YS2



YM21 YM22
 - -

YM27T2
 -

YM28T2
 -





OPEL

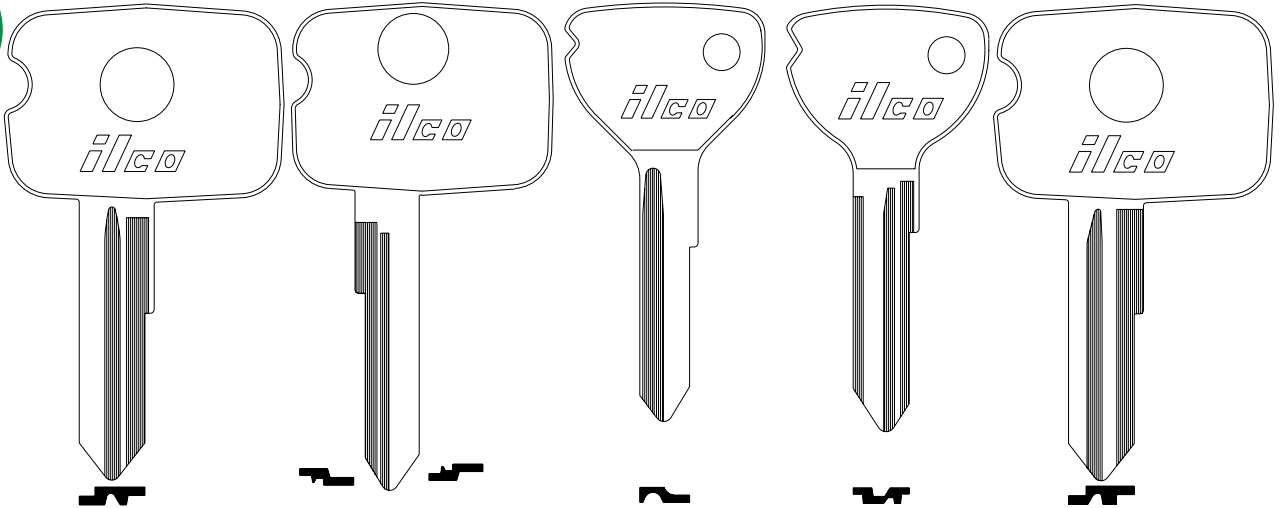

YM28

YM30 YM29

OP32

OP36

HF38

ILCO
EZ

OPEL

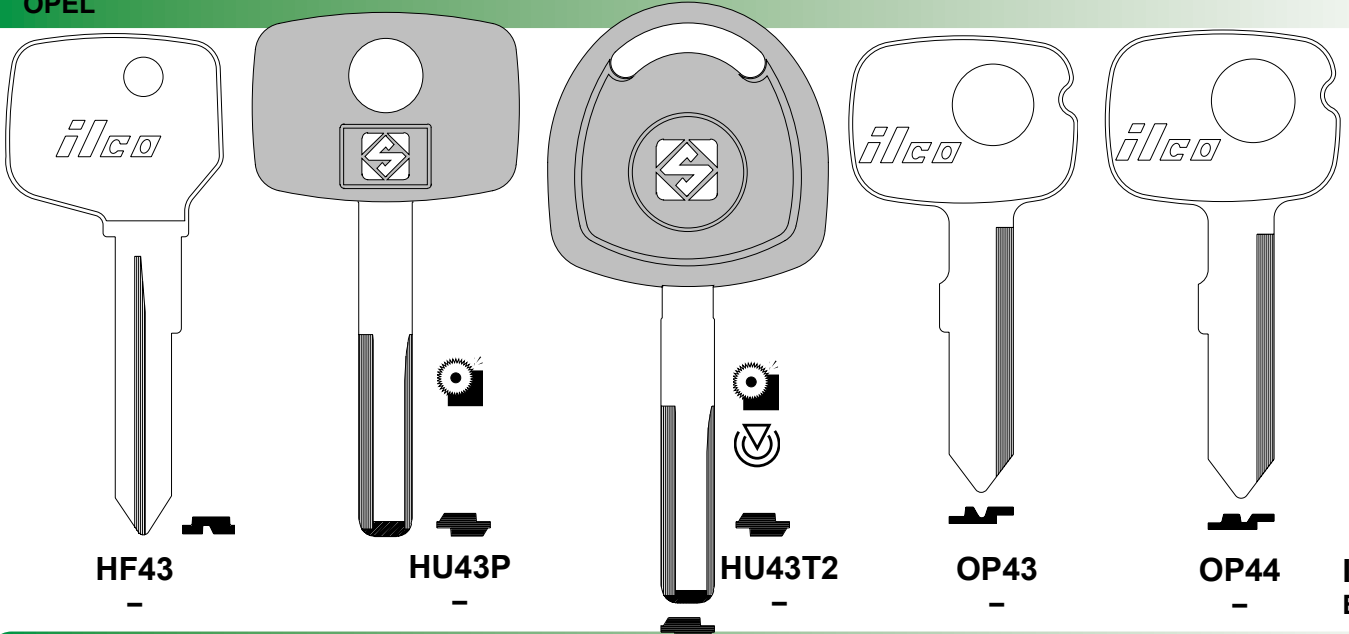

HF43

HU43P

HU43T2

OP43

OP44

ILCO
EZ

OPEL

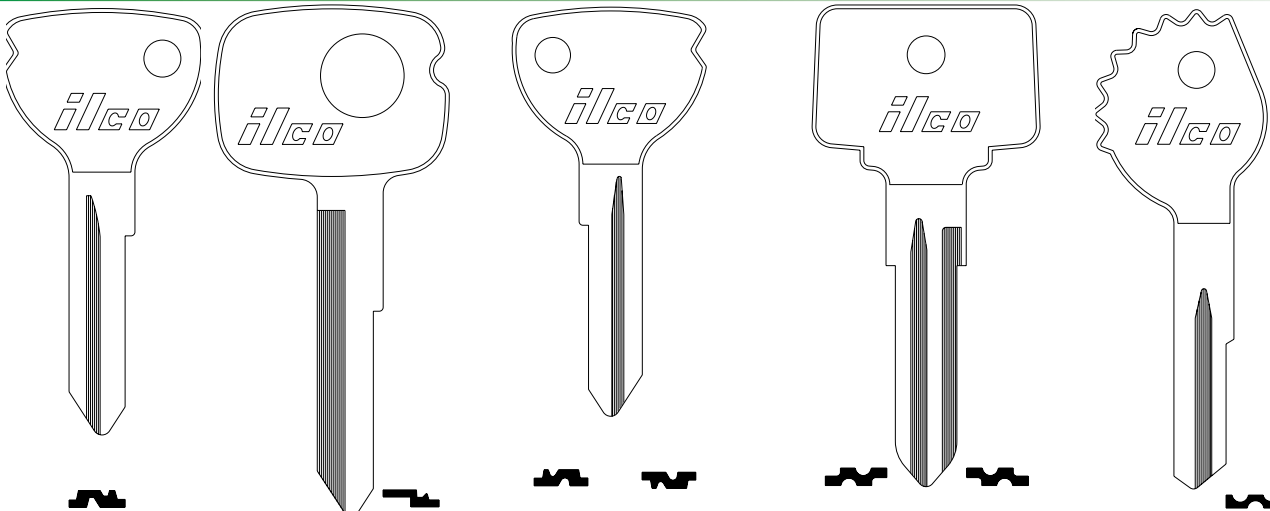

HF47

OP47

HF49

HF50

HF59

HF59R

OP60C

ILCO
EZ

VEHICLE KEYS

SEC 1

PG 162



OPEL

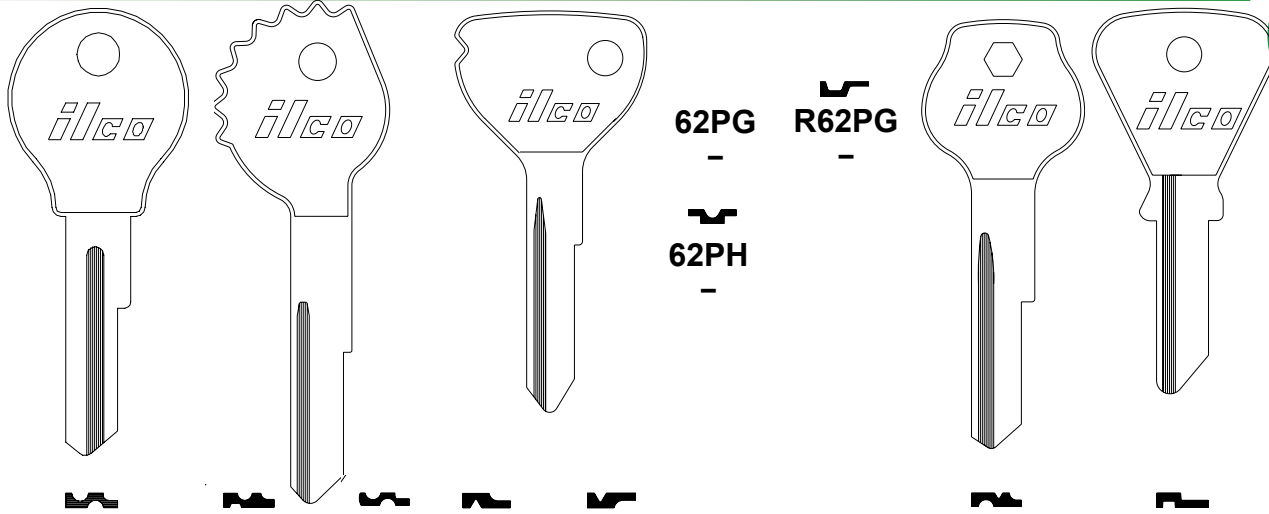

62PG
-
R62PG
-
62PH
-

ILCO 61VW 62PE L62VN 62PF R62PF 63Y 62VH
EZ - - - - -

OPEL

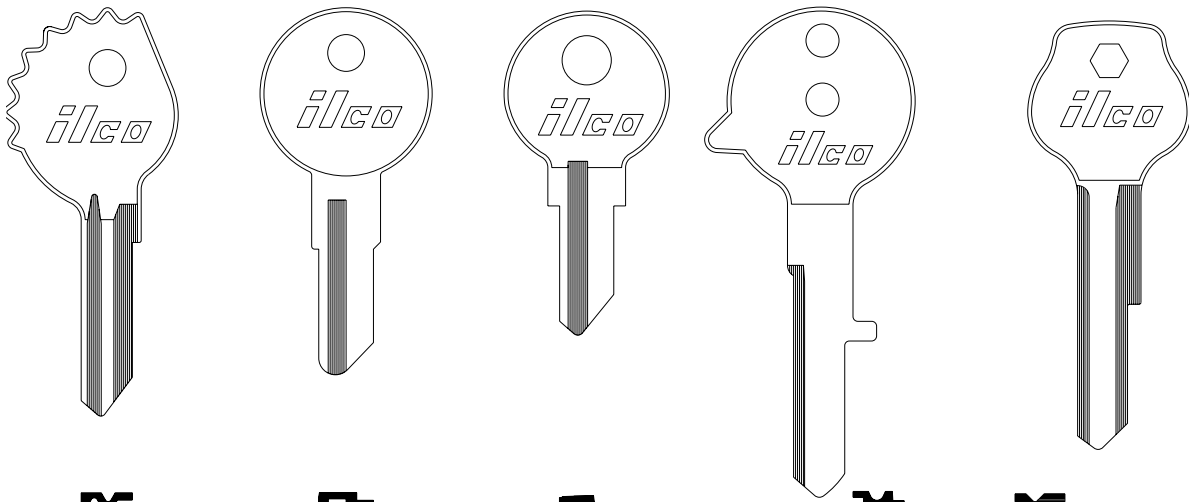

ILCO 62VJ 62VM 62VO 62VP A62VN
EZ - - - - -

OPEL

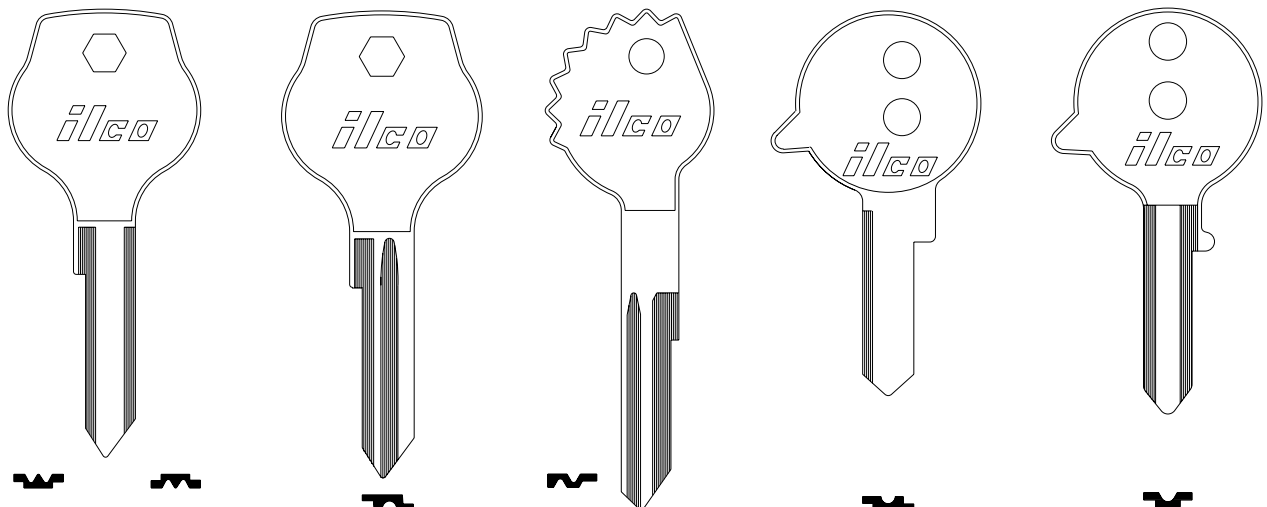

ILCO H62PD HR62PD H62VP L62VJ S62VP S62VT
EZ - - - - -





OPEL

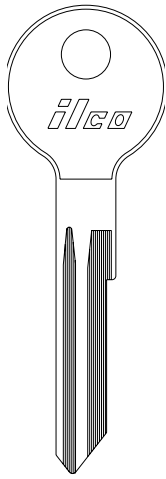

63LL

-

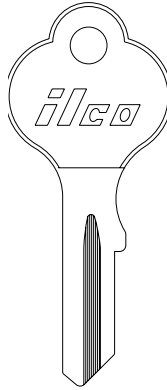

U63H

-

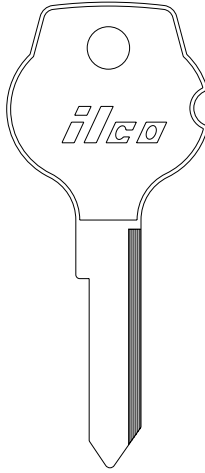

O79JE

-

O79JC
O79JC

O79JD
O79JD

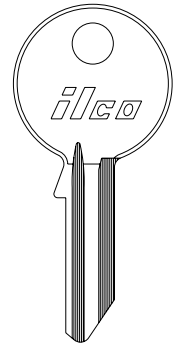

OP91G

-

ILCO
EZ

VEHICLE KEYS

OPEL

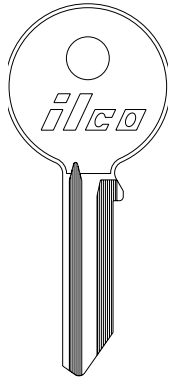

OP91S

-

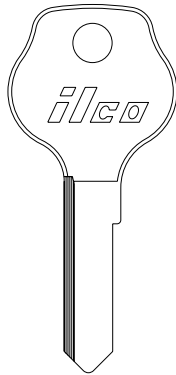

OP91SV

-

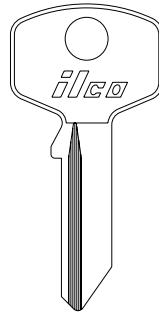

Y91C

-

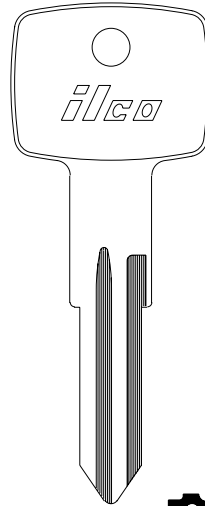

X168
B61



PANHARD

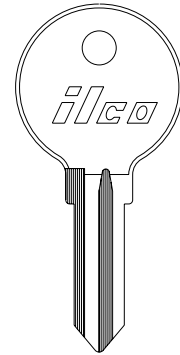

PA1

-

ILCO
EZ

PANHARD

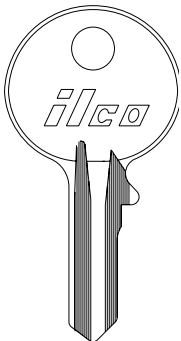

7DC

-

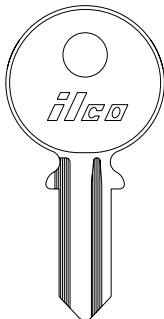

62BZ

-

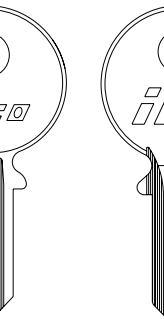

R62BZ

-

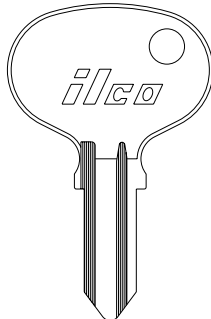

62R

-



H64K

-



HR64K

-



P64H

-

P64K
-



P65A
-

P65C
-

ILCO
EZ

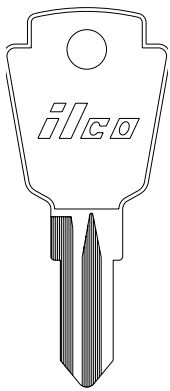

PANHARD



ILCO
EZ PA91
-

PANTERA

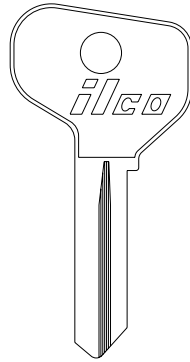

FT37 FT38
- -

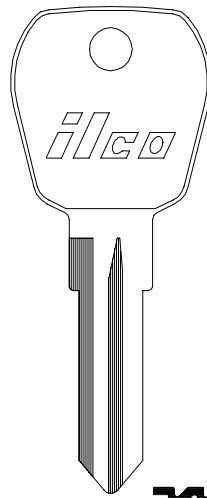

X86
FC7

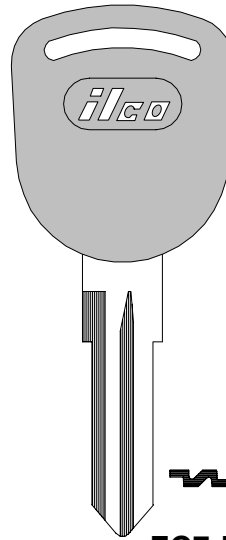

FC7-P
-

PETERBILT

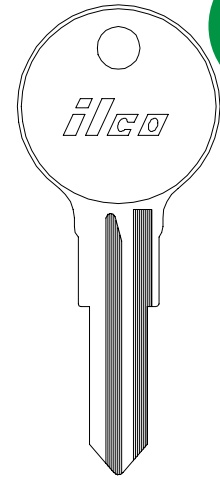

X53
V32

PETERBILT

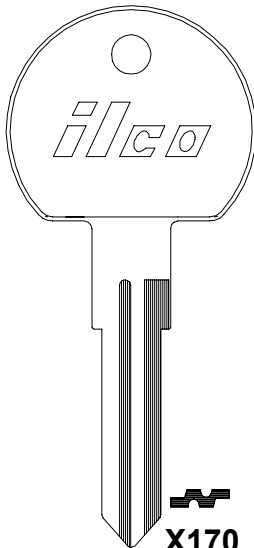

ILCO
EZ X170
NE48

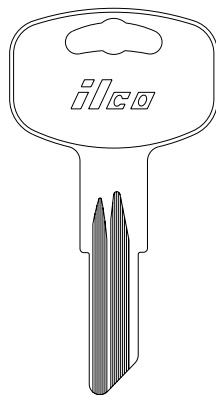

1098PB
-

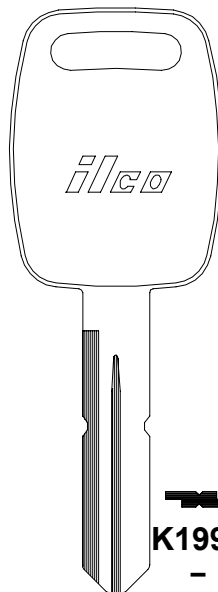

K1994
-

PEUGEOT

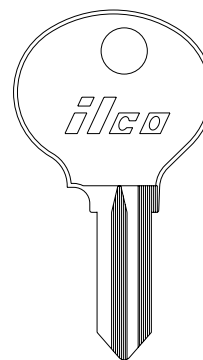

KM1
-

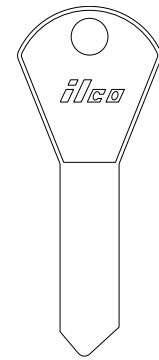

LA1
-

PEUGEOT

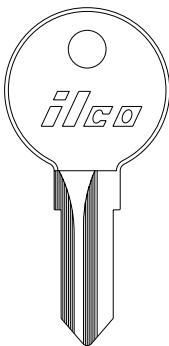

ILCO
EZ KM2 KM3
- -

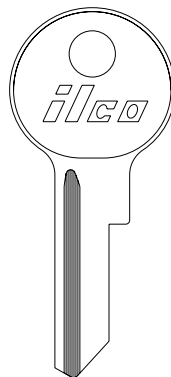

NE4
-

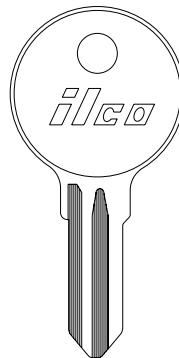

SM4
-

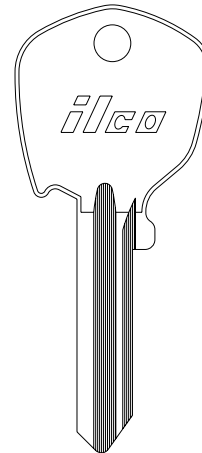

FT6
-

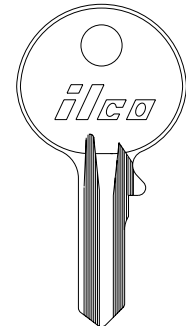

7DC R7DC
- -

VEHICLE KEYS



PEUGEOT

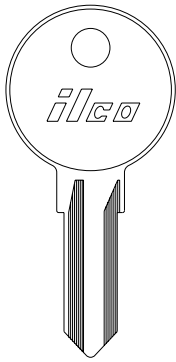

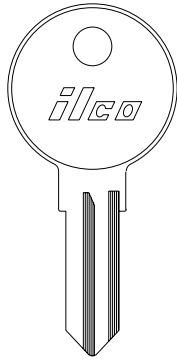

KM8
-



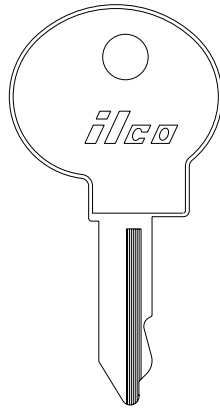

X89
KM9

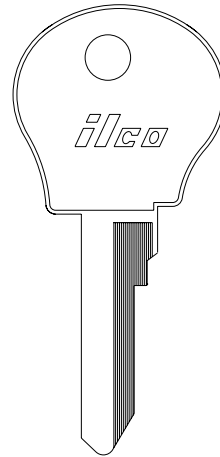

KM10
-



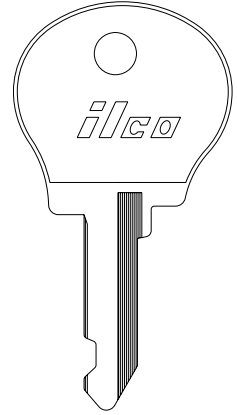

X12
RE61F



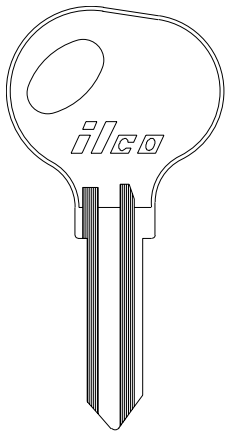

NE18
-

ILCO
EZ

PEUGEOT



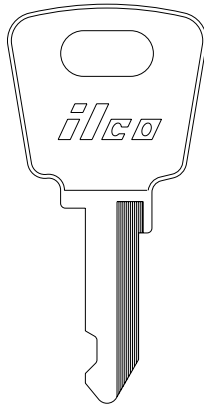

RT19
-



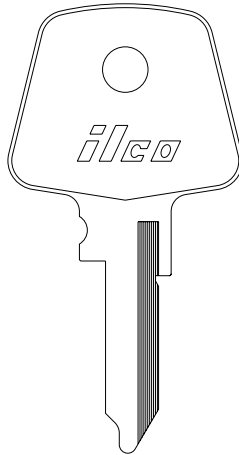

NE27
-

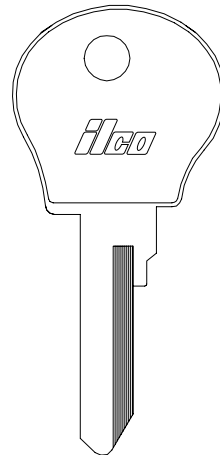

NE31
-

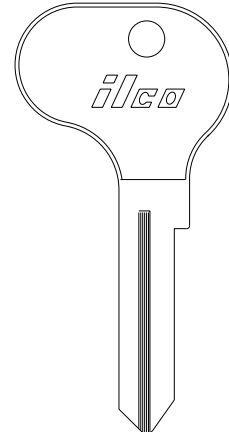

NE39
-





NE41
-

NE42
-

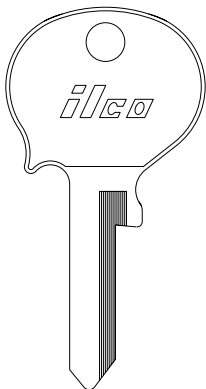

NE43
-

ILCO
EZ

PEUGEOT



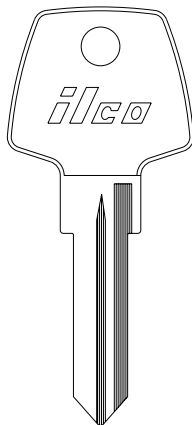

NE44
-



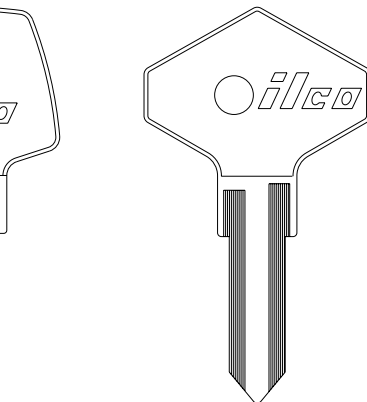

NE45
-

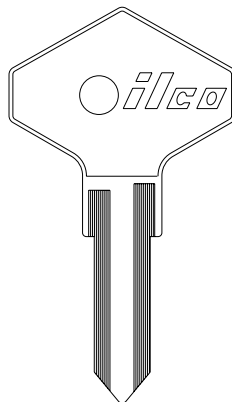



NE47
-

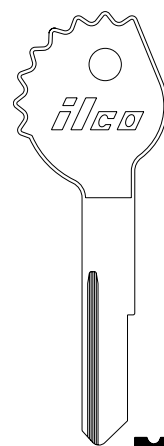

NE46
-

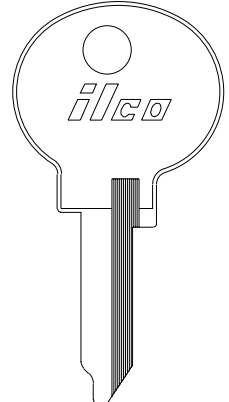

61PE 61PS
-





RE61XR
-

ILCO
EZ

VEHICLE KEYS

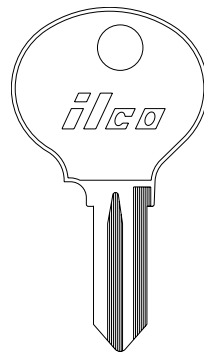
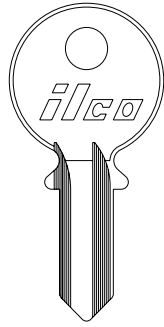
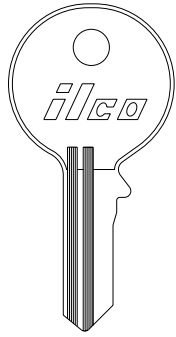
PEUGEOT



N63G

NR63G

-

-

ILCO V61S VR61S
EZ - -

62Z R62Z
- -

63G R63G
- -

63H R63H
- -

PEUGEOT

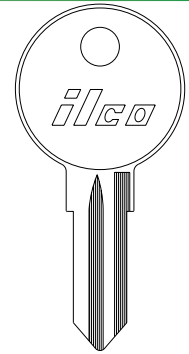
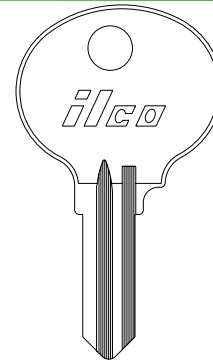
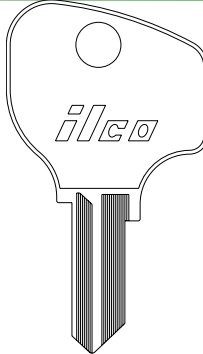
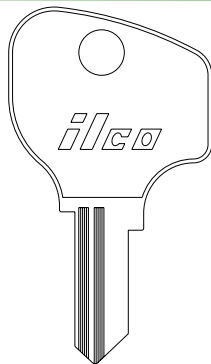
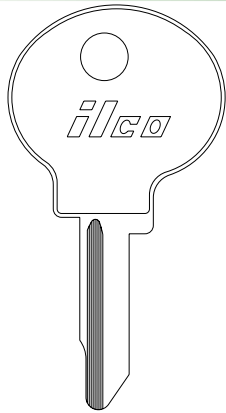

ILCO 63M 63Q
EZ - -

63P
-

63PX R63PX
- -

H63G
-

L63G LR63G
- -

PEUGEOT

PEUGEOT MOTORCYCLE

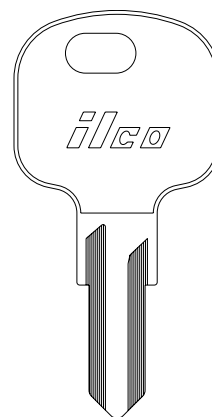
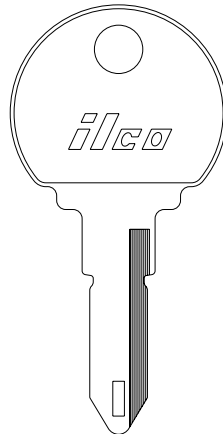
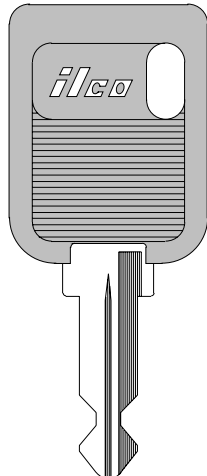
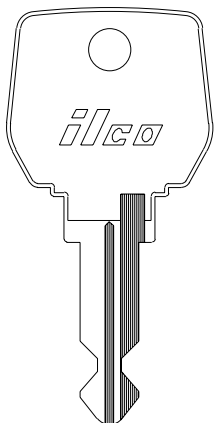

ILCO X116
EZ RN24

RN24-P
-

X147
RN30

X148
PG5

NE74T5-SI
-



SEC 1
PG 167



PEUGEOT MOTORCYCLE

PIAGGIO



NE74P-SI



ZD7-SI



NE71RDP-SI

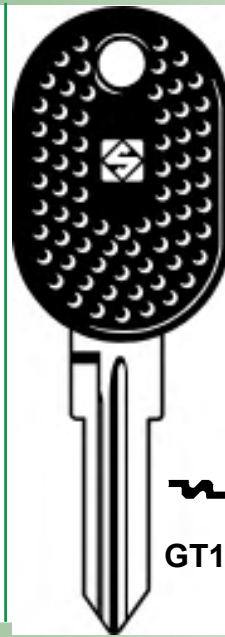

GT15RP-SI



GT15RDT5-SILCO
EZ



VEHICLE KEYS

PIAGGIO

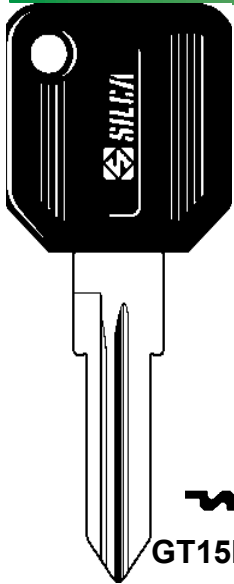

GT15RAP



ZD17RAP-SI

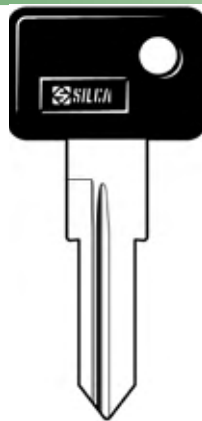

ZD16RP-SI

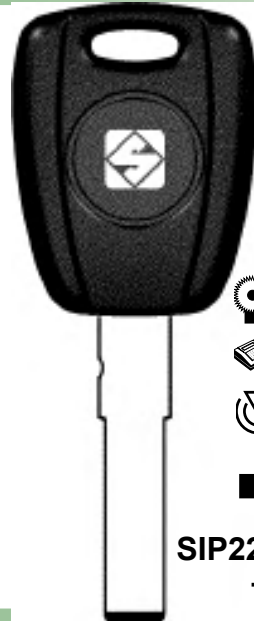

SIP22T5-SI

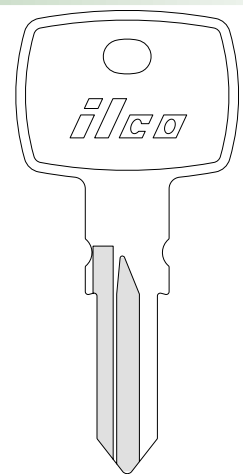

X270
TMC1

ILCO
EZ

PIPER AIRCRAFT PLYMOUTH

POLARIS

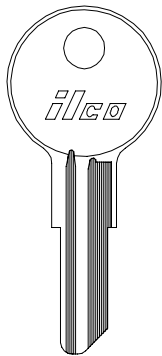

SEE
CHRYSLER

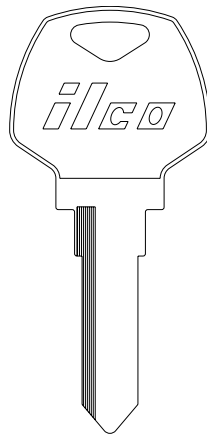

HD51

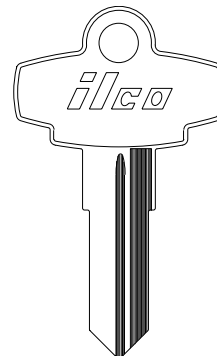

752

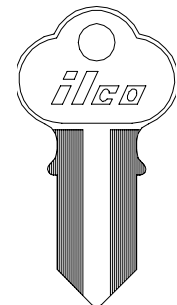

1041GB

ILCO
EZ

SEC
1
PG
168

O1122 Y11
O1122A Y12



POLARIS

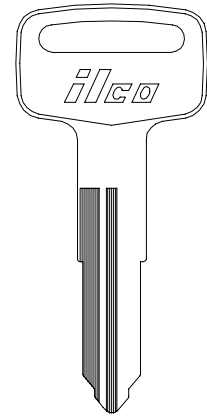
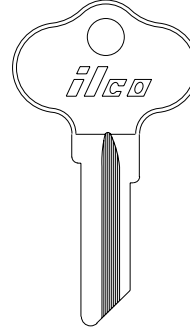
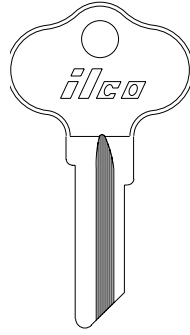
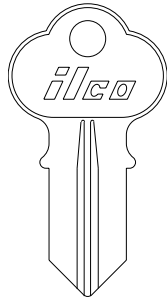
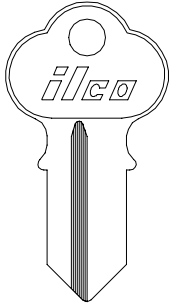

ILCO
EZ
1041GR
-

1041K
-

CH3
-

CH7
-

X117
YH48

POLARIS

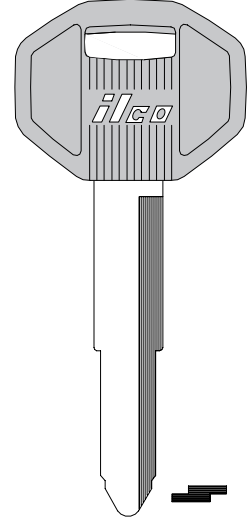
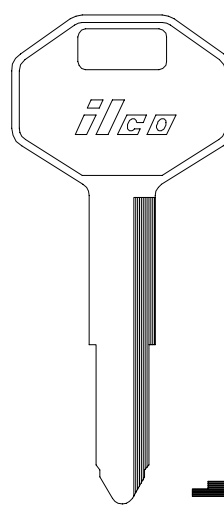
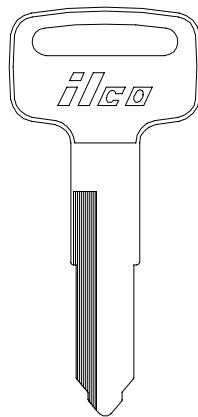
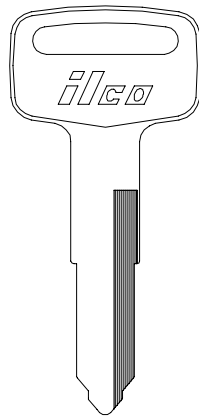
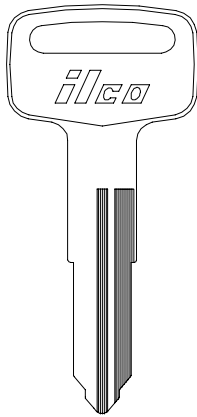

ILCO
EZ
X118
YH49

X119
YH47

X120
YH46

X121
DC3

DC3-P (-PC)
-

POLARIS

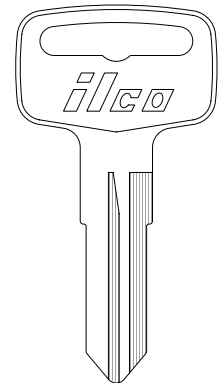
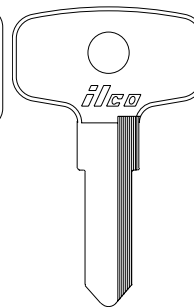
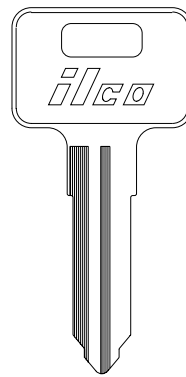
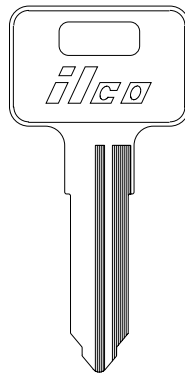
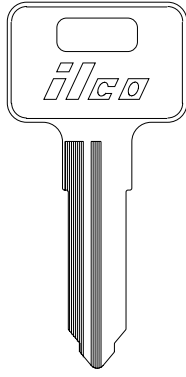
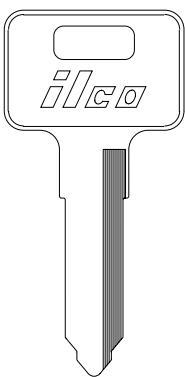

ILCO
EZ
X259
-

X260
-

X261
-

X262
-

YH26
-

YH33
-



POLARIS

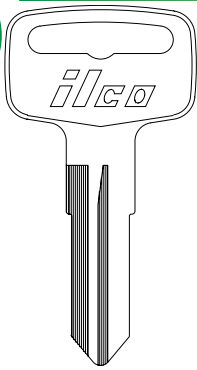

YH34
-

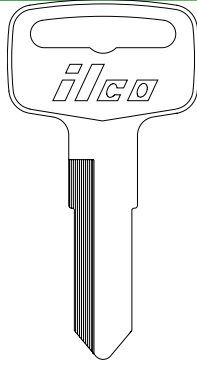

YH38
-

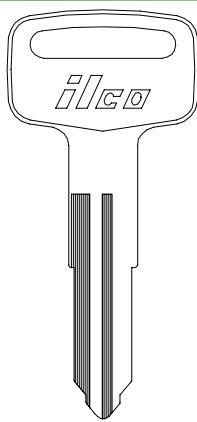

YH50
-

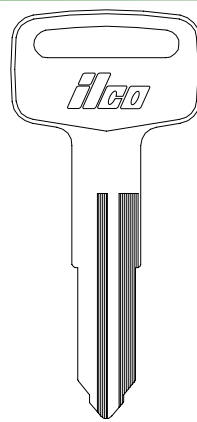

YH51
-

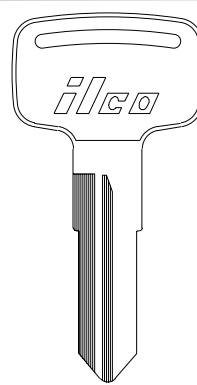

YM55
-

ILCO
EZ

VEHICLE KEYS

POLARIS

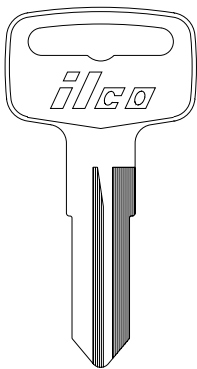

YM56
-

PONTIAC

**SEE
GENERAL
MOTORS**

PORSCHE

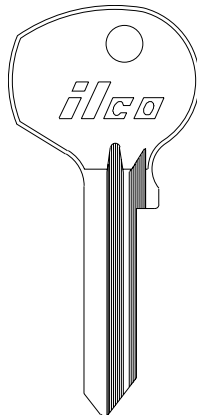

KP1
-

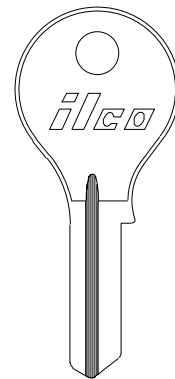

PO2
-

ILCO
EZ

PORSCHE

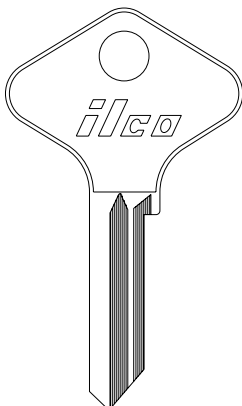

DM2
-

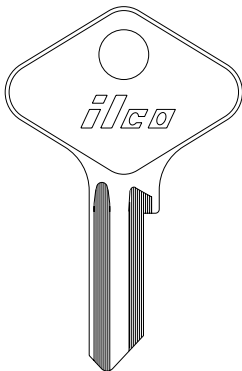

DM3
-

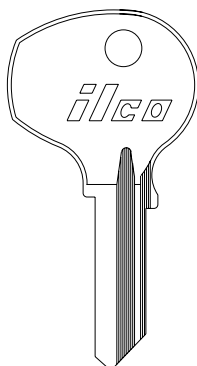

DM4
-

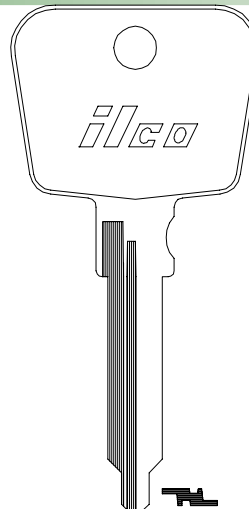

PO5
-

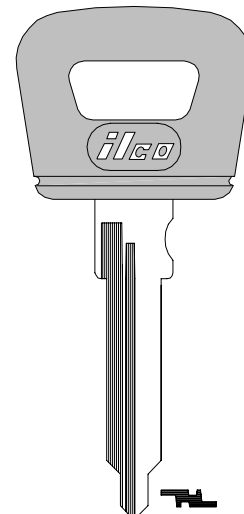

PO5-P
-

ILCO
EZ

PORSCHE

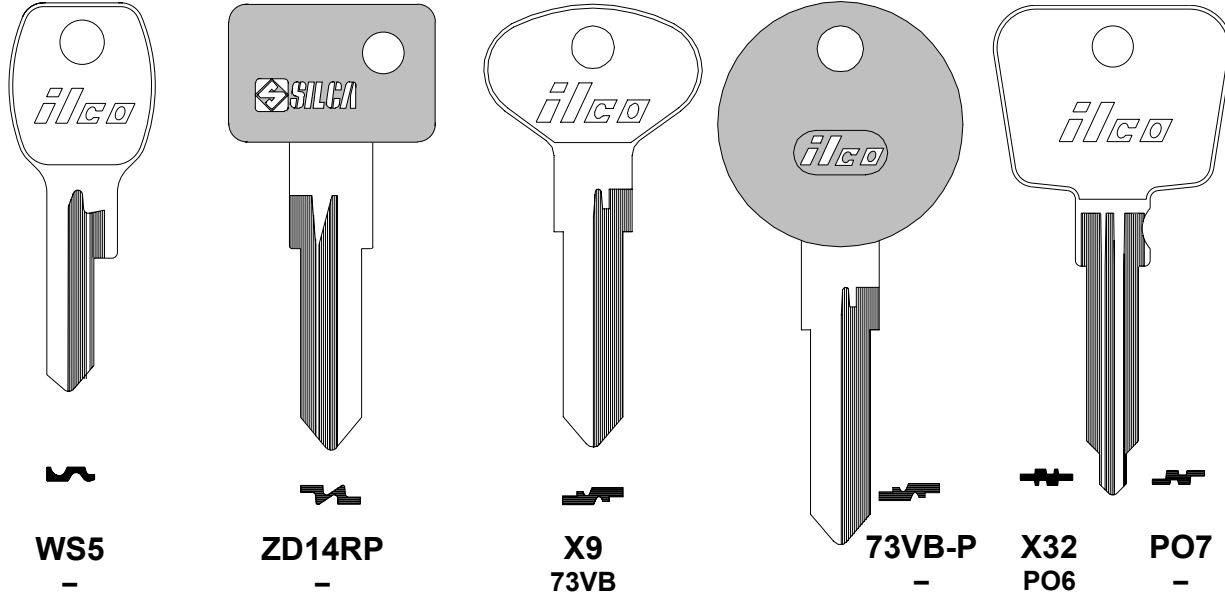

ILCO
EZ

WS5
-

ZD14RP
-

X9
73VB

73VB-P
-

X32
PO6

PO7
-

PORSCHE

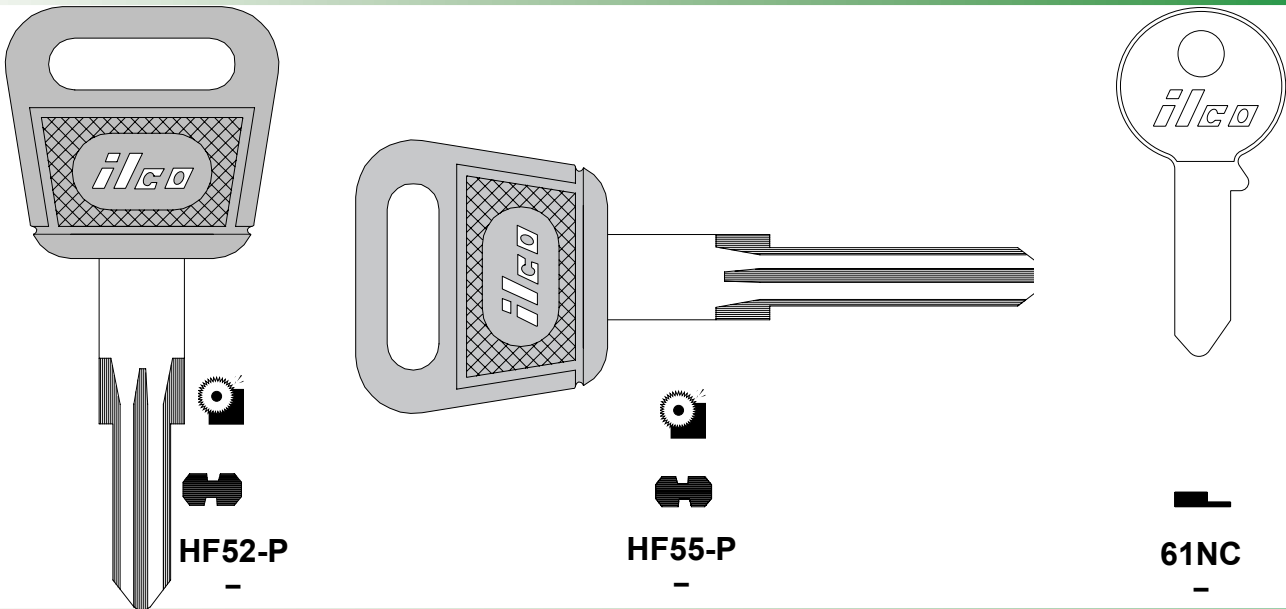

ILCO
EZ

HF52-P
-

HF55-P
-

61NC
-

PORSCHE

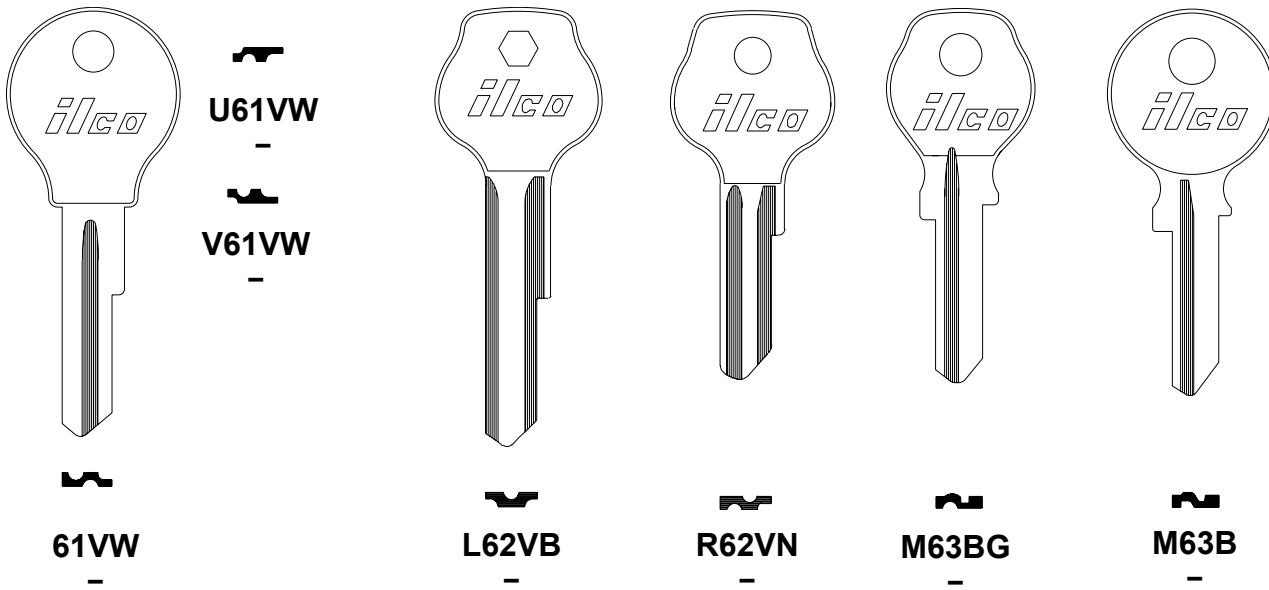

ILCO
EZ

61VW
-

U61VW
-
V61VW
-

L62VB
-

R62VN
-

M63BG
-

M63B
-



VEHICLE KEYS



PORSCHE

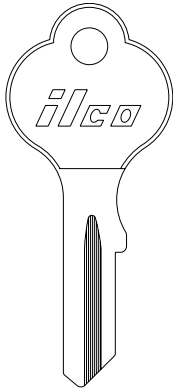

U63H

-

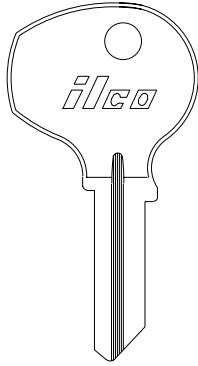

64K

-

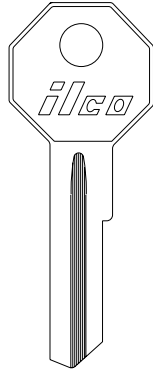

64KK

-

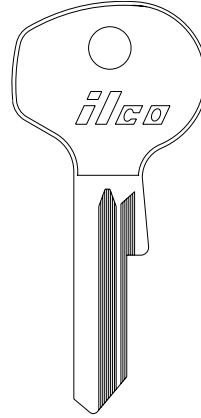

P79B

-

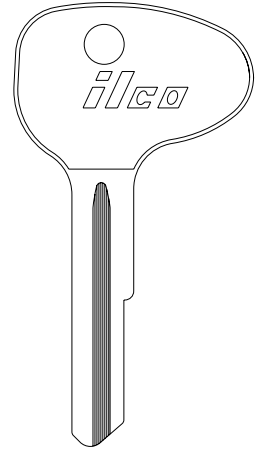

A81N

-

**ILCO
EZ**



VEHICLE KEYS

PORSCHE

POST OFFICE

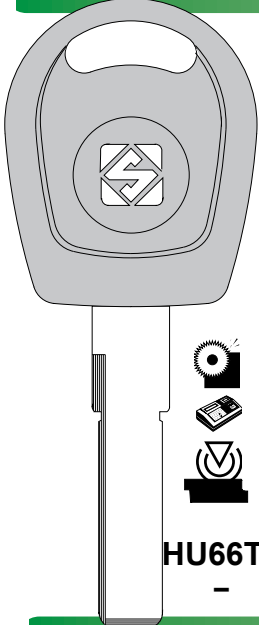

HU66T5

-

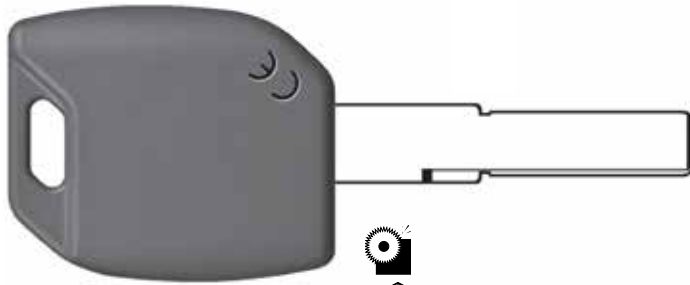

HU66MH

-

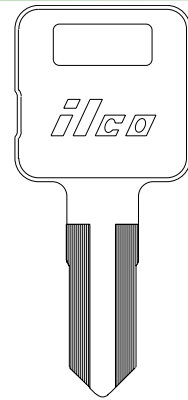

1524

-



**ILCO
EZ**

PRINCE

PUCH-SEARS

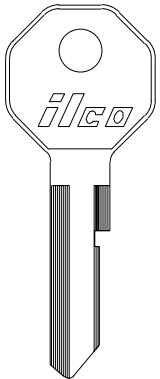

NL1

-

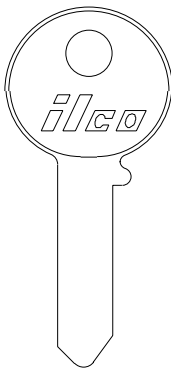

LA10

-

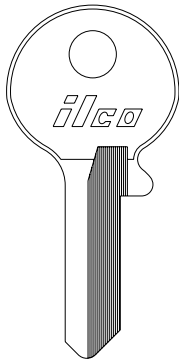

64AL

-

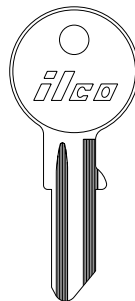

GE2

-



GE4

-

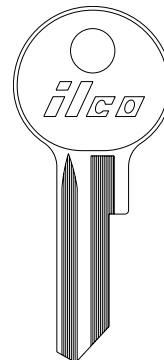

GE7

-

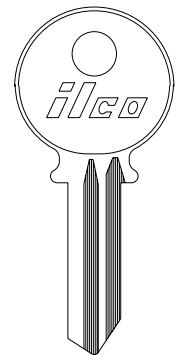

GE9

-

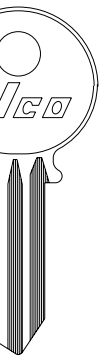

GE14

-



**ILCO
EZ**

SEC 1

PG 172



PUCH-SEARS

RALEIGH CYCLE

RENAULT

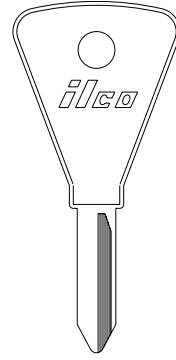
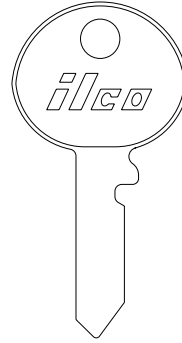
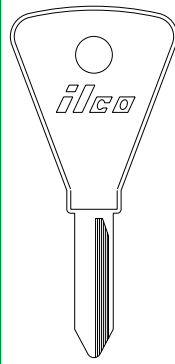
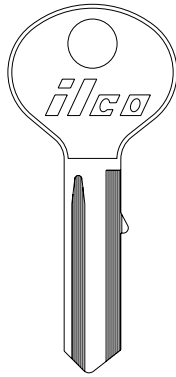
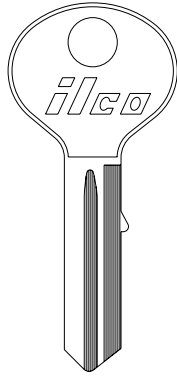
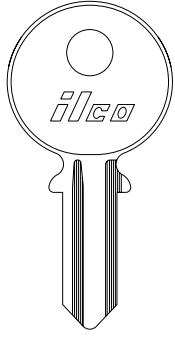

ILCO R62BZ
EZ -

64P
-

P66E
-

62DN
-

62DO
-

DP1
-

RENAULT

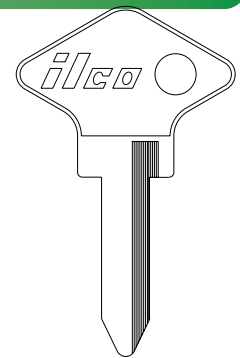
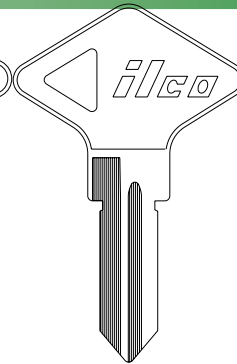
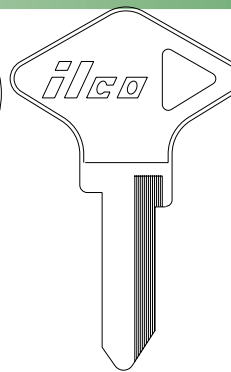
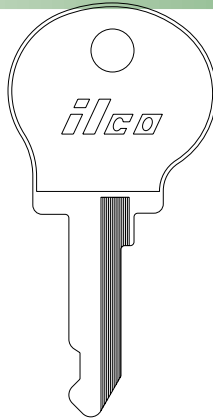
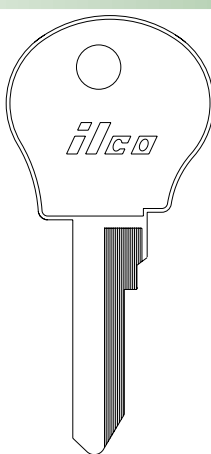
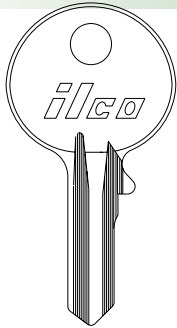

ILCO 7DC R7DC
EZ - -

X12 R61F

NE13
-

NE14
-

NE15
-

NE16
-

NE29
-

RENAULT

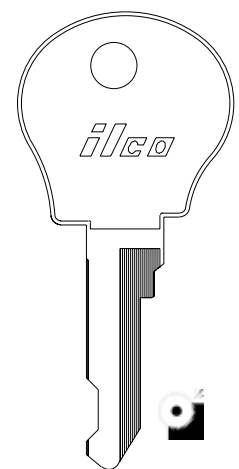
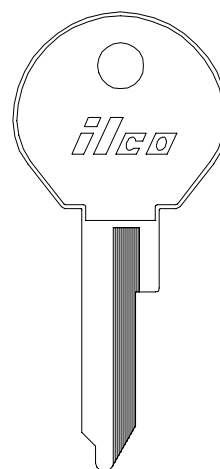
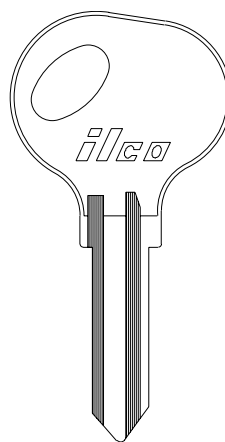
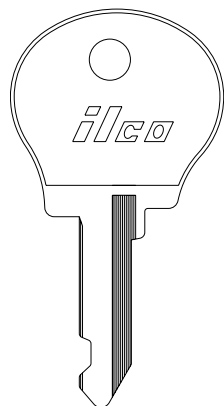
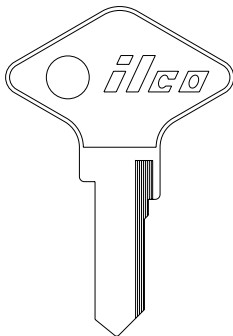

ILCO NE17
EZ -

NE18
-

RT19
-

NE20
-

NE22
-





RENAULT

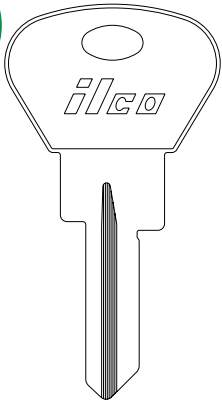

VC24
-

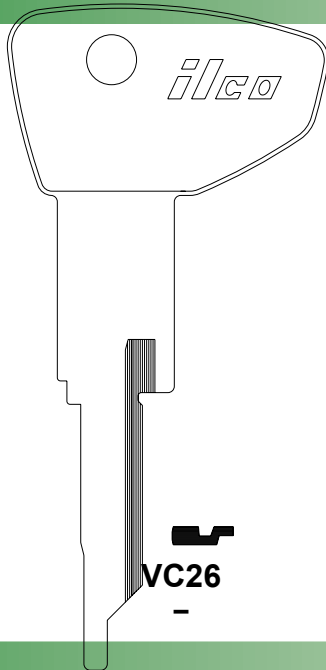

VC26
-

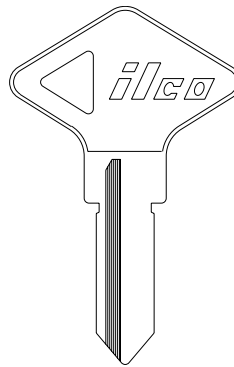

VC29
-

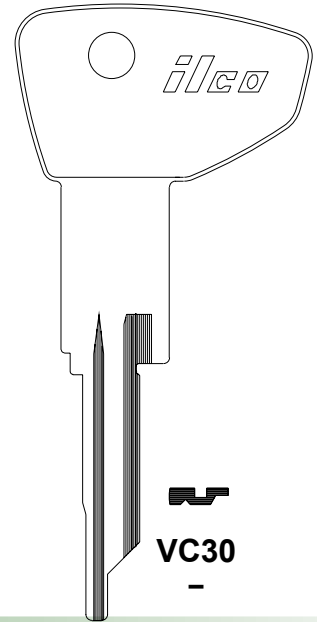

VC30
-

ILCO
EZ

RENAULT

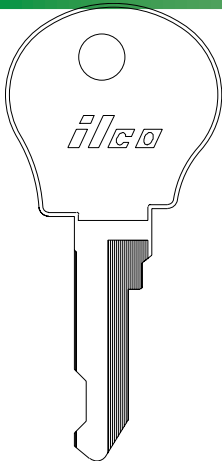

NE22
-

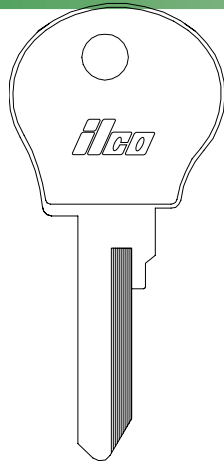

NE39
-

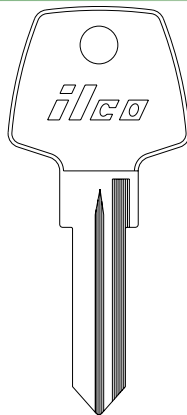

NE45
-



HV61
-

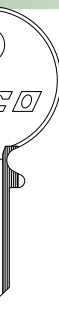

HVR61
-

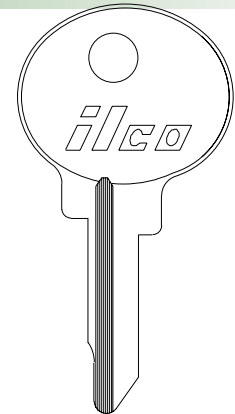

RE61N
-

ILCO
EZ

RENAULT

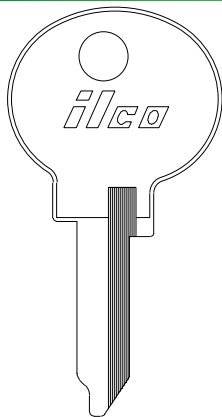

RE61XR
-

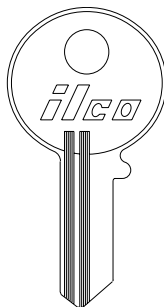

V61S
-



VR61S
-

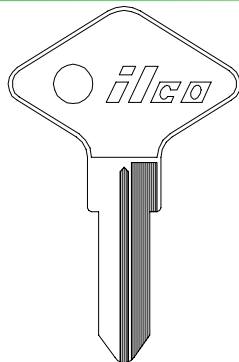

X61
NE40

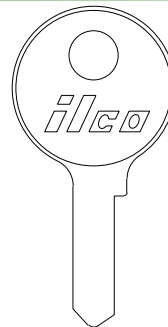

62VC
-



62Z
-



62U



62R
-



R62UC
-



R62Z
-

ILCO
EZ

VEHICLE KEYS

RENAULT

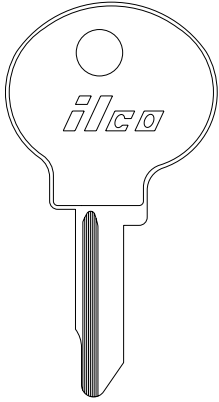

RK4
-
64X
-

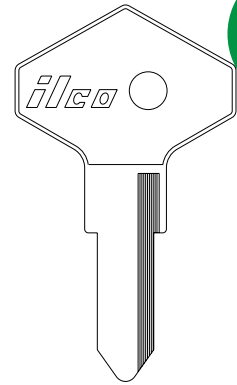
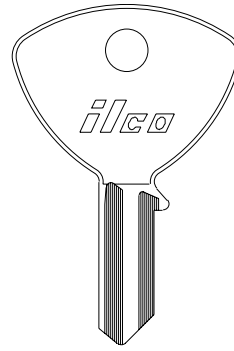
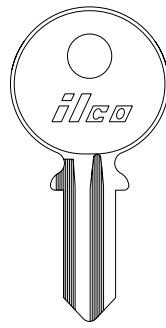

VEHICLE KEYS

ILCO 63M
EZ -

63Q
-

64R
-

P64K
-

R80B
-

X85
NE36

X92
RN25

RENAULT

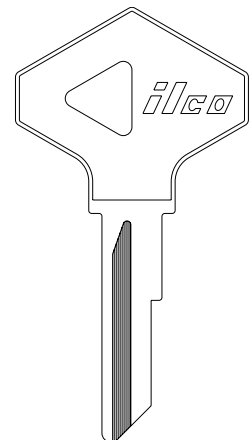
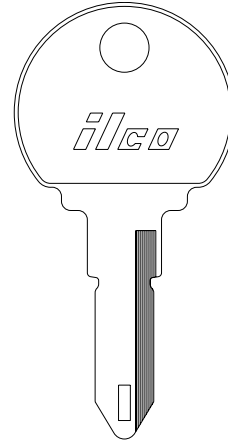
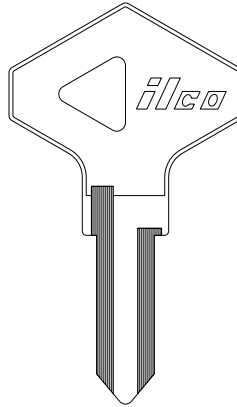
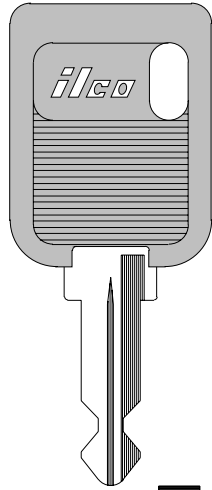
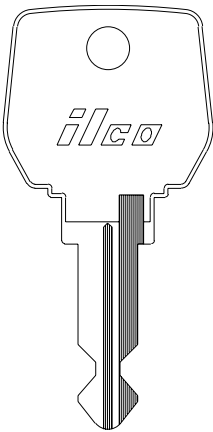

ILCO
EZ

X116
RN24

RN24-P
-

X122
RN29

X147
RN30

X150
RN27

RENAULT

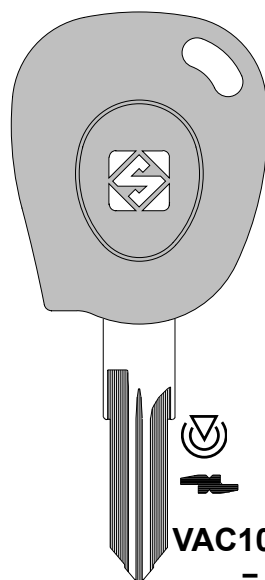
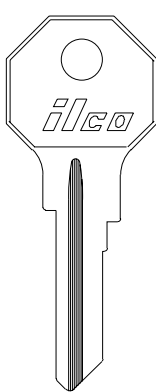
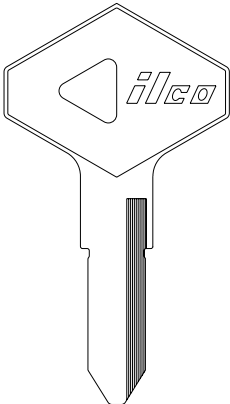

ILCO
EZ

X171
RN31

H199N
-

VAC102T1
-

VAC102-GTS
-





VEHICLE KEYS

RILEY

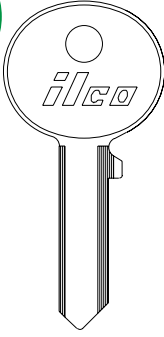

62DB
-

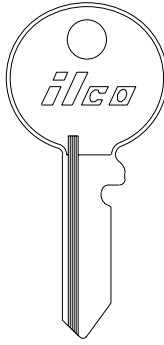

62DP
-

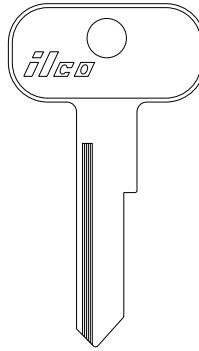

H62DP
-

RIZZATO

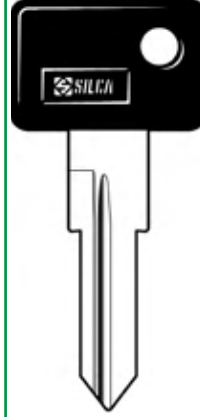

ZD16RP-SI
-

ROLLS ROYCE

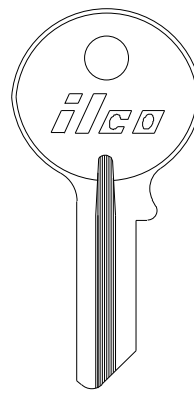

YL5
-

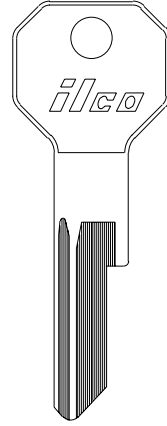

X28
62HE

ILCO
EZ

ROLLS ROYCE/BENTLEY

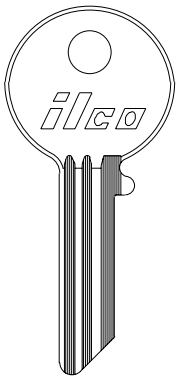

62HA
-

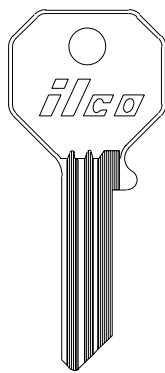

62HB
-

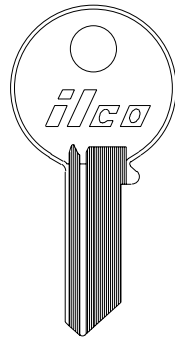

62HC
-

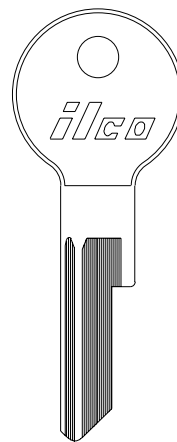

62HD
-

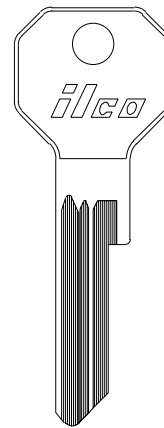

62HF
-

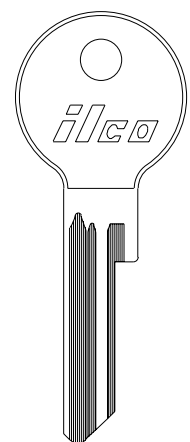

62HG
-

ILCO
EZ

ROLLS ROYCE

ROOTE GROUP

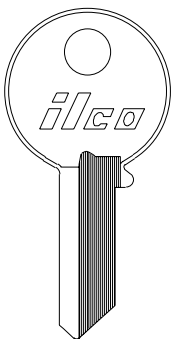

62JB
-

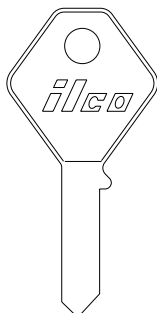

SR1
-

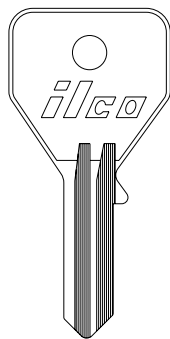

SR2
-

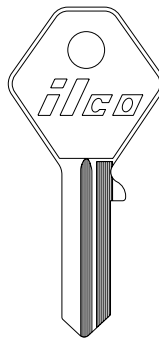

BR5
-

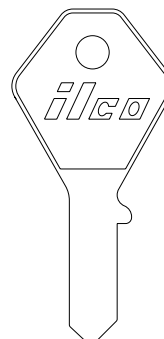

BR6
-

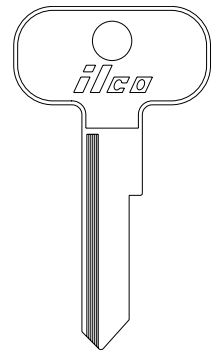

BR7
-

BR9
-

ILCO
EZ



ROOTE GROUP

ILCO	X16	X17	62DG	62DP			
EZ	P1771CR	S1771CR	-	-			
	62DC		62DH	M72F			
	-	-	-	-			
					B62DR	H62DG	HR62DG
					-	-	-

ROOTES GROUP ROVER

ILCO	X13	X29	X86	FC7-P	X157
EZ	LF4	VO73	FC7	-	LF17
	H62DP				
	-				

ROVER

ILCO	NE71R	NE75EHP	X170
EZ	-	-	NE48
	NE71RDP-SI		
	-		





ROVER

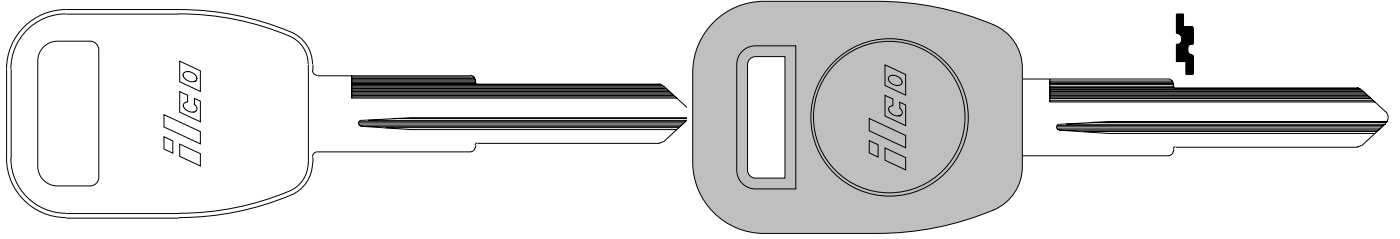



X239
RV4

RV4-P
-

ILCO
EZ

VEHICLE KEYS

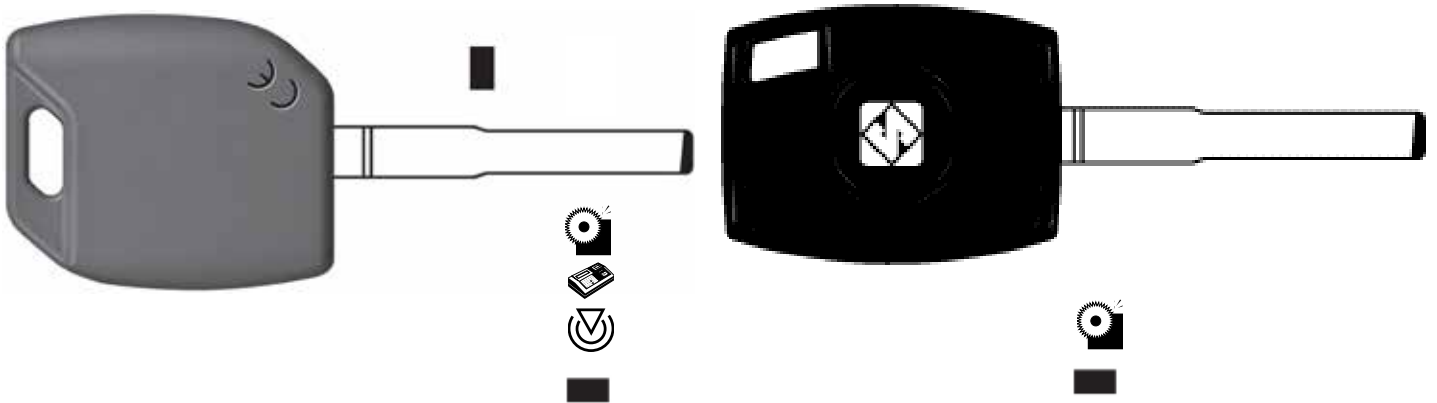
ROVER



HU101MH
-

HU101-GTS
-

ILCO
EZ

ROVER

SAAB

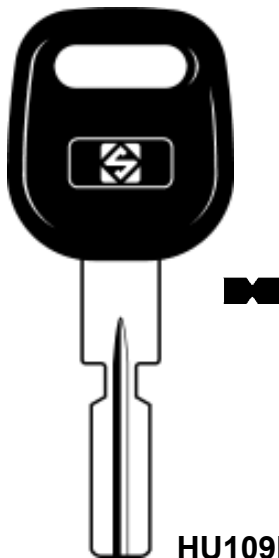

HU109FP
-

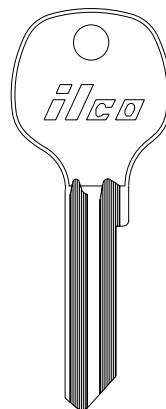



SB1
-

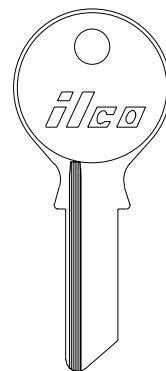

SB2
-

SB3
-

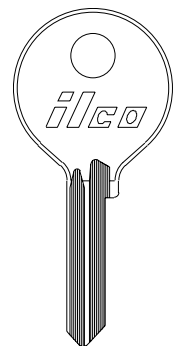



SB4
-



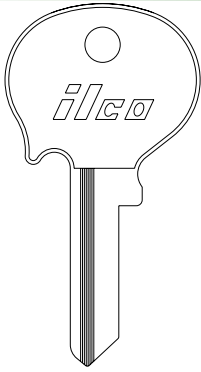

SB5
-

ILCO
EZ

SAAB

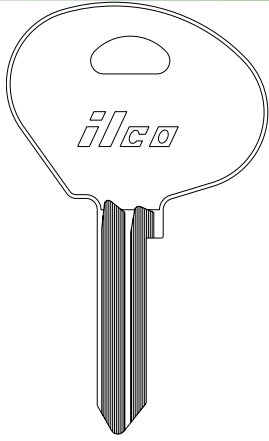

ILCO
EZ NE5
-



SB6
-

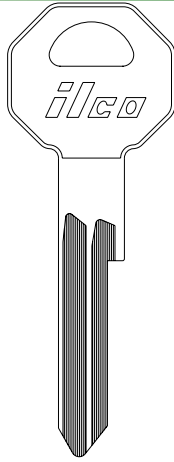

SB7
-

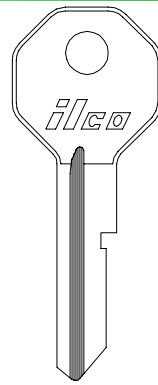

SB10
-

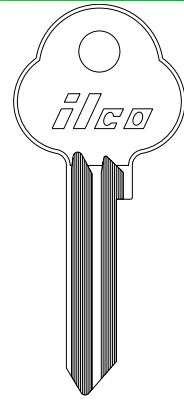

SB11
-

SAAB

VEHICLE KEYS

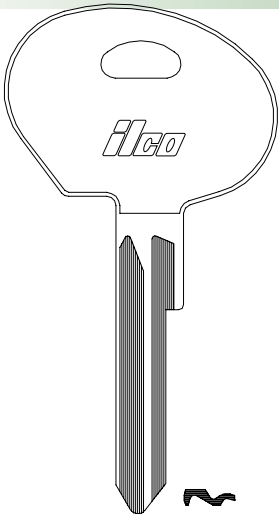

ILCO
EZ

X131
SB8

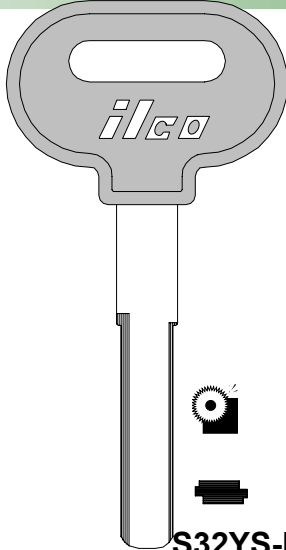

S32YS-P
-

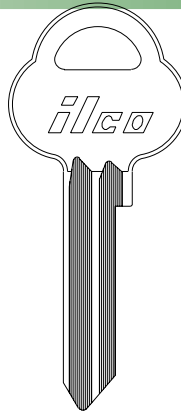

AS41
-

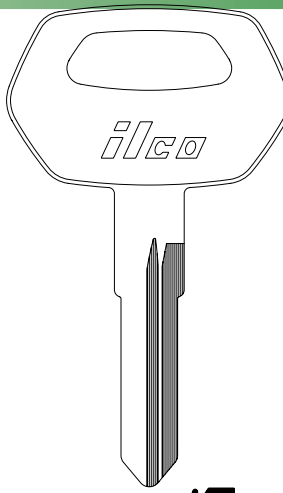

X52
SAA1

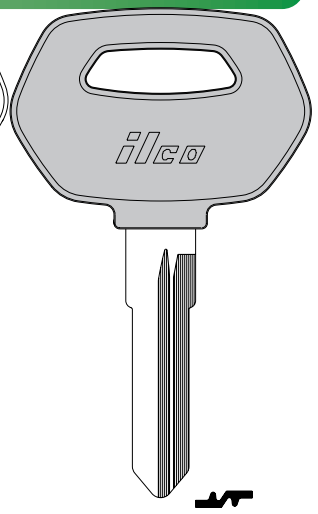

SAA1-P
-

SAAB

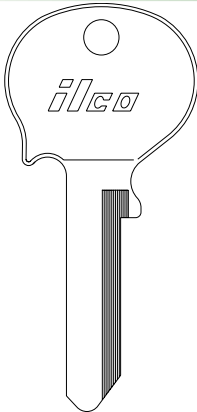

ILCO
EZ H61VR
-

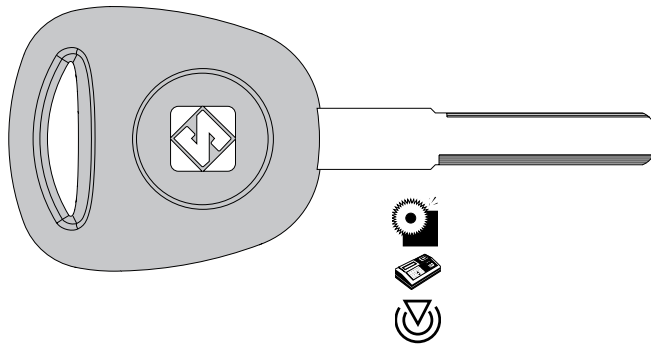

YM30T5
-

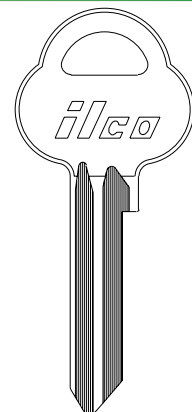

SR61W
-





SAAB



62DF
-

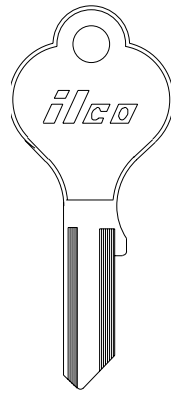

U62VA
-

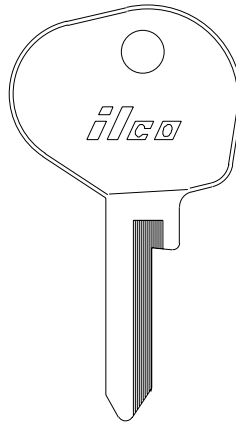

V80P
-

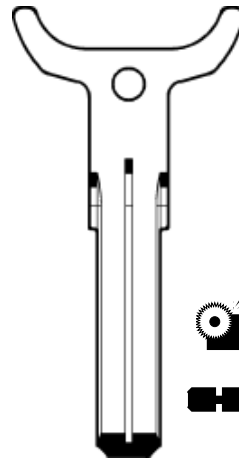

WT47T
-



62DC
-

ILCO
EZ

VEHICLE KEYS

SATURN

SCISSOR LIFT

SEAT

SEE
GENERAL
MOTORS

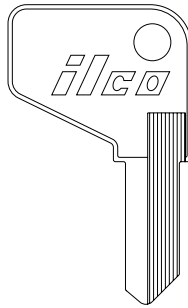

1627
-

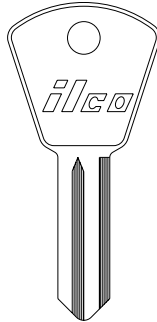

SE1B
-

SE2B
-
SE3B
-
SE4B
-

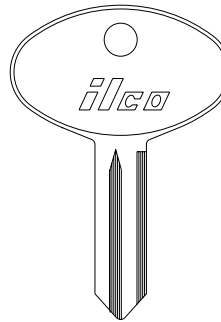

SE1C
-

SE2C
-
SE3C
-
SE4C
-

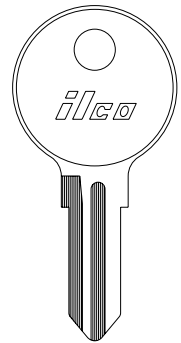

SE5F
-

ILCO
EZ

SEAT

SIMCA/TALBOT/MATRA

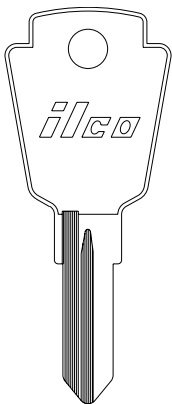

SMS8
-

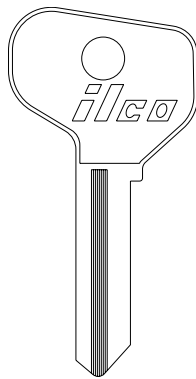

F54
-

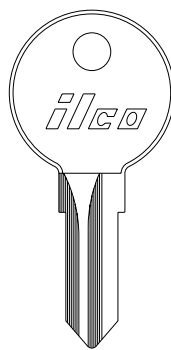

KM2
-

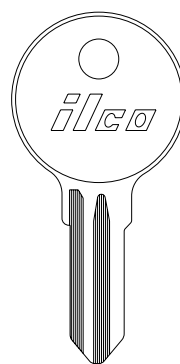

KM3
-

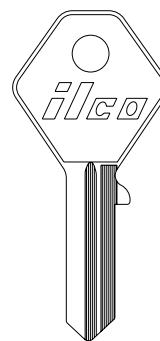

SM4
-

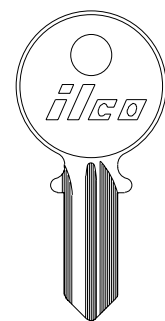

BR6
-

SM6
-

SM7
-

ILCO
EZ

SIMCA/TALBOT/MATRA

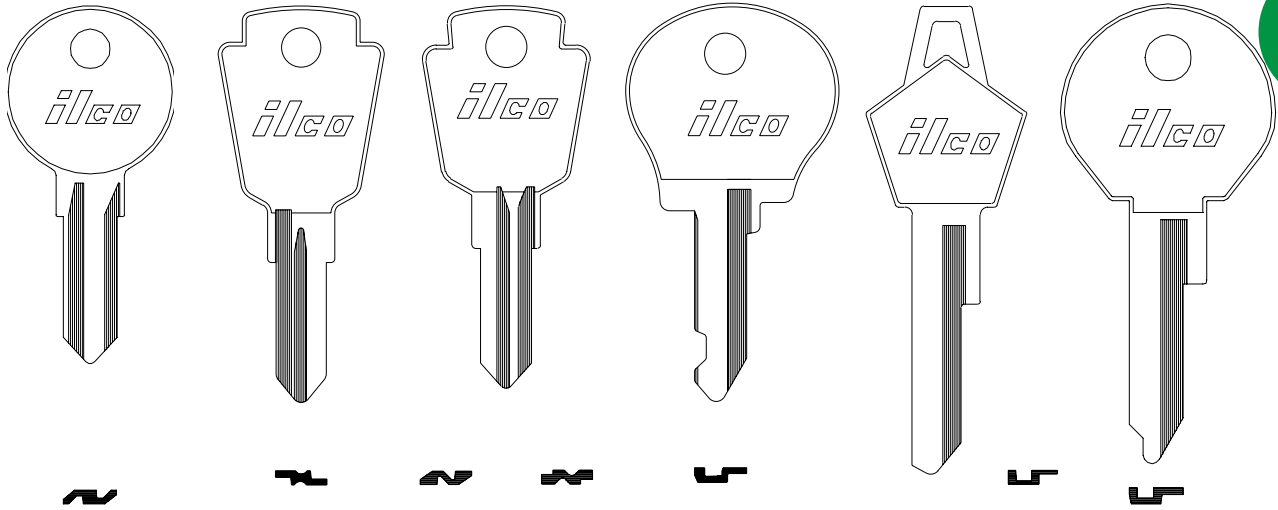

ILCO EZ	KM8	SMS8	SM9C	S91W	NE18	NE19	NE20
-	-	-	-	-	-	-	-

SIMCA/TALBOT/MATRA

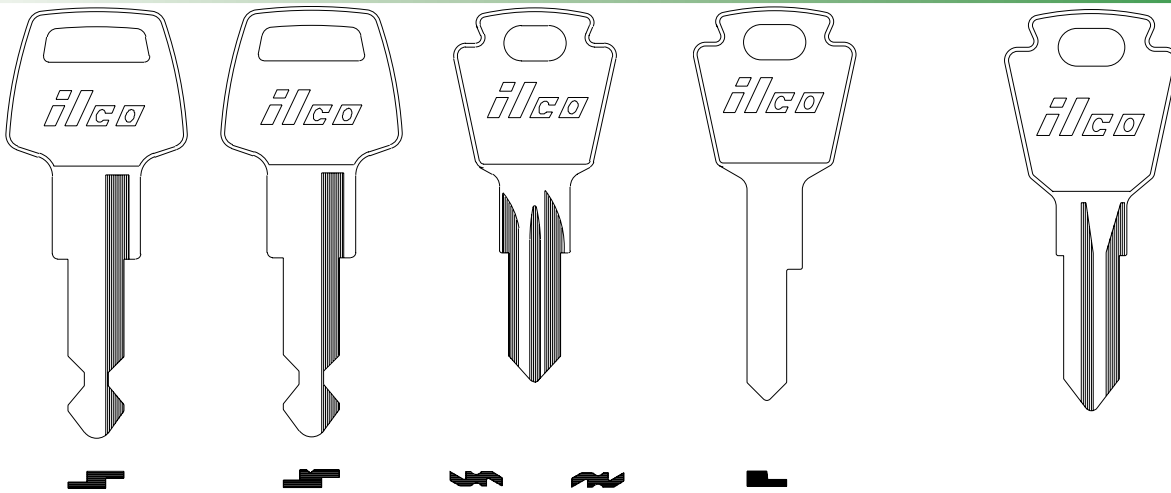

ILCO EZ	NE26	NE34	61P	R61P	61PC	61PE	61PS
-	-	-	-	-	-	-	-

SIMCA/TALBOT/MATRA



ILCO EZ	H61P	HR61P	HV61	HVR61	RE61XR	62R	62Z
-	-	-	-	-	-	-	-



SIMCA/TALBOT/MATRA

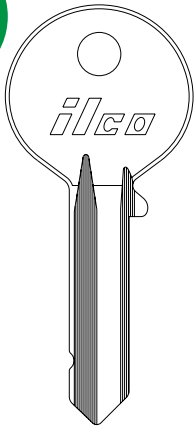

62RS
-

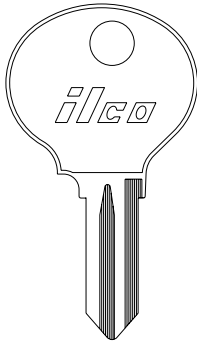

63G
-

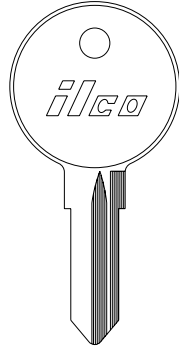

R63G
-

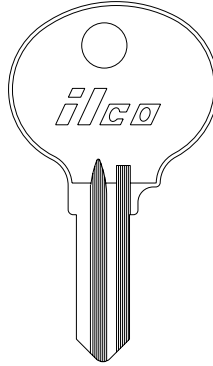

63H
-

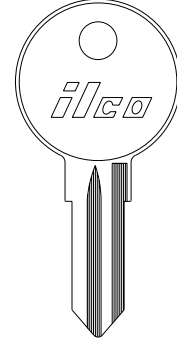

R63H
-

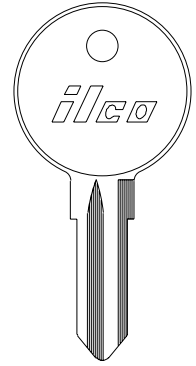

H63G
-

L63G LR63G
-

N63G
-

**ILCO
EZ**

VEHICLE KEYS

SIMPLES

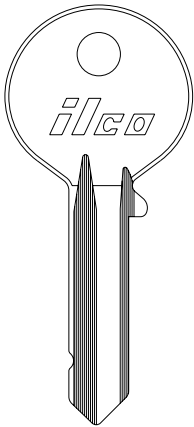

62RS
-

SKODA

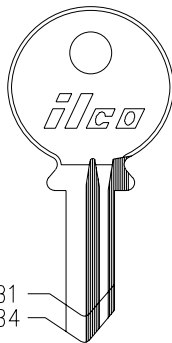

FB1
FB4

FB1 FB4
-

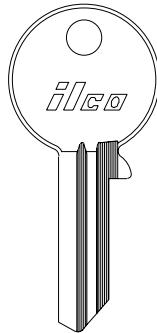

FB5
-

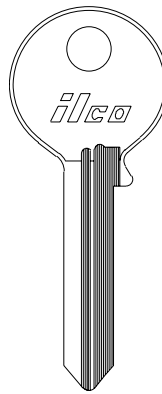

FB6
-

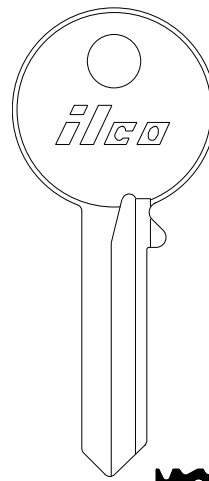

65CA
-

65CD
-

65CE
-

65CF
-

65CB
-

**ILCO
EZ**

SKODA

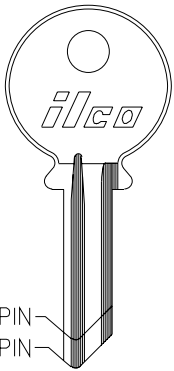

4 PIN
5 PIN

4 PIN 5 PIN
F65 F65A
-

4 PIN 5 PIN
FR65 FR65A
-

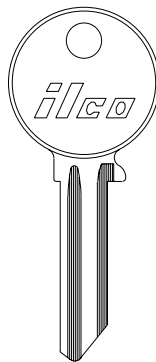

F65L
-



FR65S
-

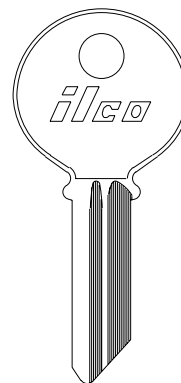

S65CA
-

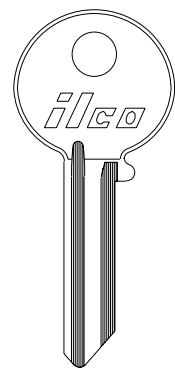

UF65A
-

**ILCO
EZ**

SKODA

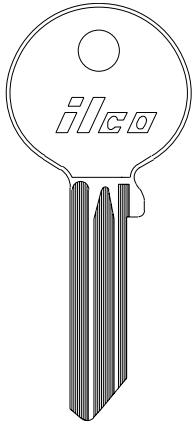

ILCO SK91E SK91H
EZ - -

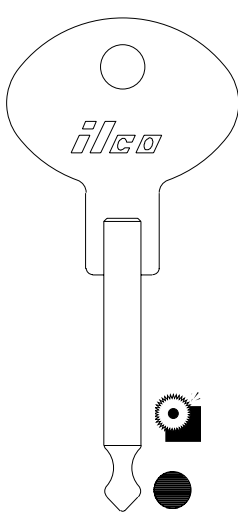

138
-

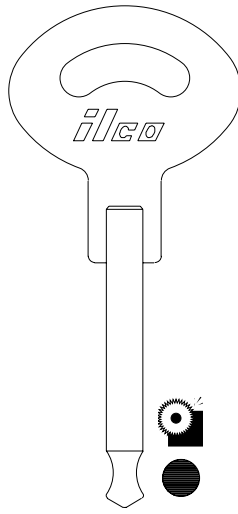

139
-

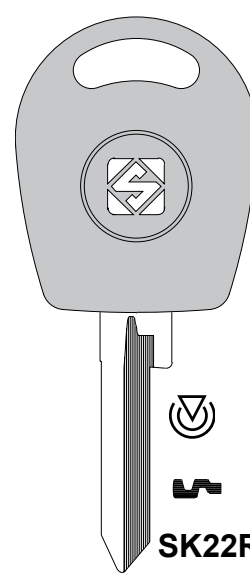

SK22RT1
-

SKODA MOTORBIKE SMART

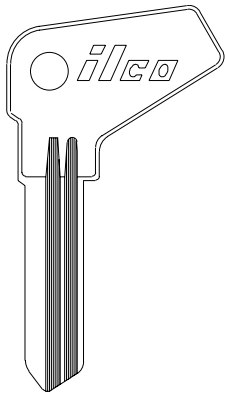

ILCO FB7
EZ -



VA6MH
-



VA2-GTS
-



VA2FB
-

STERLING TRUCK

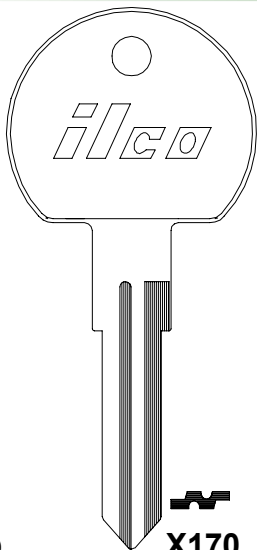

ILCO X170 NE48
EZ -

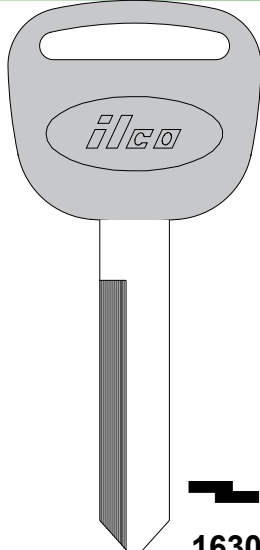

1630-P
-



Y160-GTK
(Complete Key)

GTH
(Head Only)

EB3-A-Y160
(Blade Only)





STUDEBAKER

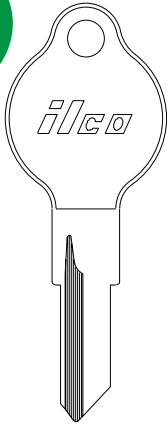

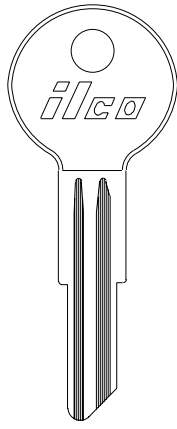

64SS
-



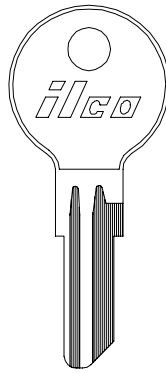

L1122A
Y101

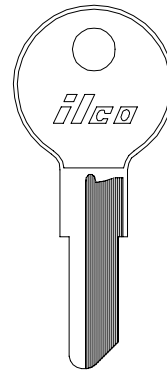



L1122AR
-

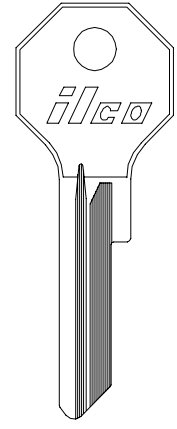

O1122A
Y12

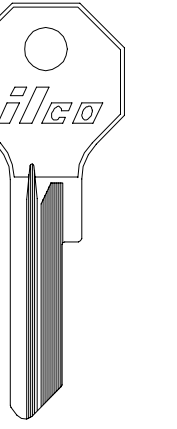

O1122AR
Y14





X1199AR
Y133

ILCO
EZ

VEHICLE KEYS

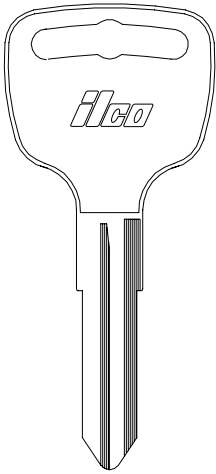
SUBARU



SJ1
-

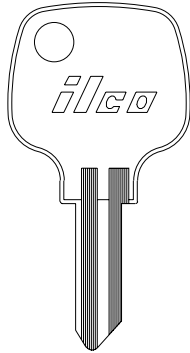

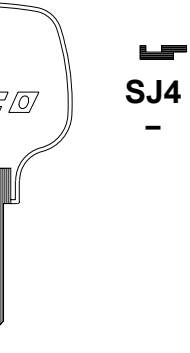

SJ2
-



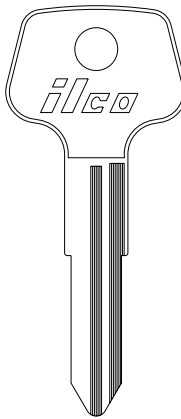

SJ3
-

SJ4
-



SJ5
-

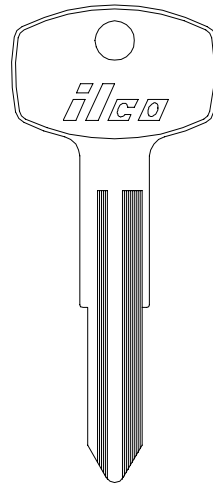

SJ6
-



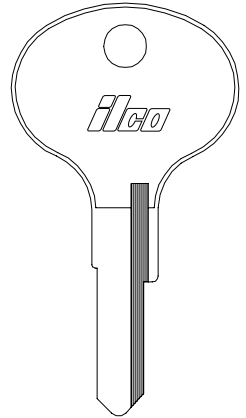

X6
62DT



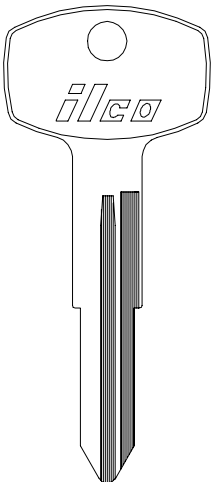

X108
SR6

ILCO
EZ

SUBARU



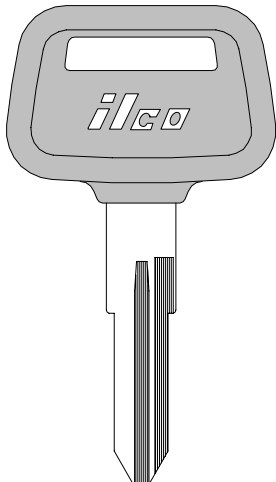

X115
DA23



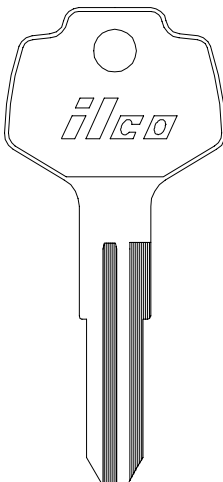

DA23-P
-

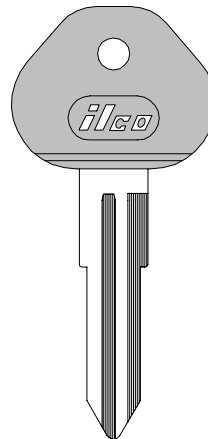

X123
DA25



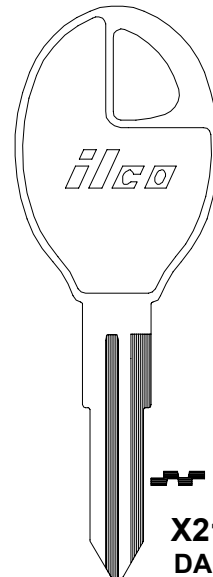

DA25-P (-PC)
-



X210
DA31

ILCO
EZ

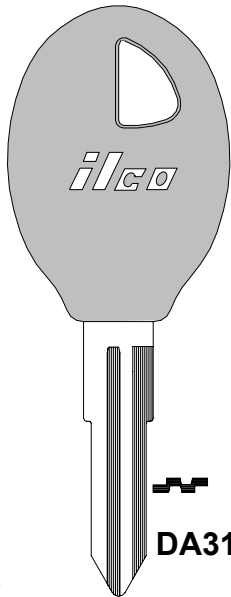
SUBARU



ILCO
EZ

DA31-P (-PC)
-

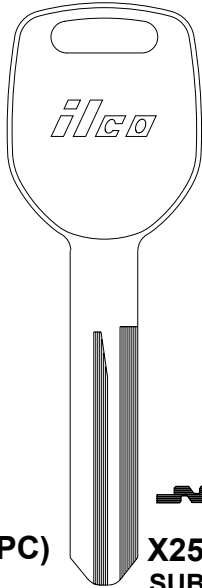

X251
SUB1

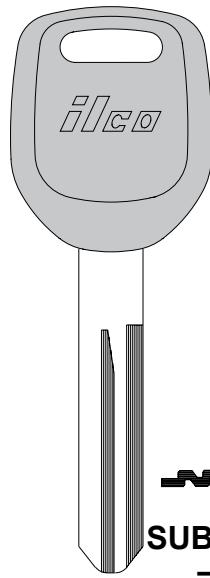

SUB1-P
-

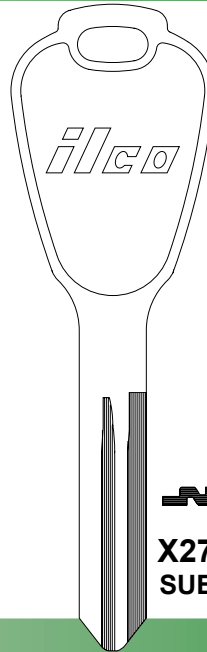

X271
SUB2

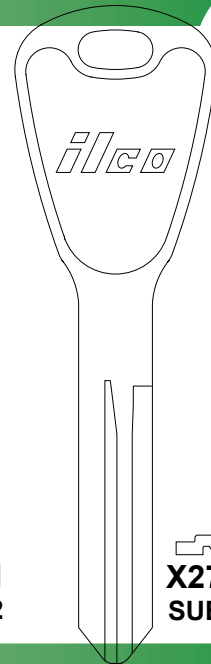

X272
SUB3

SUBARU

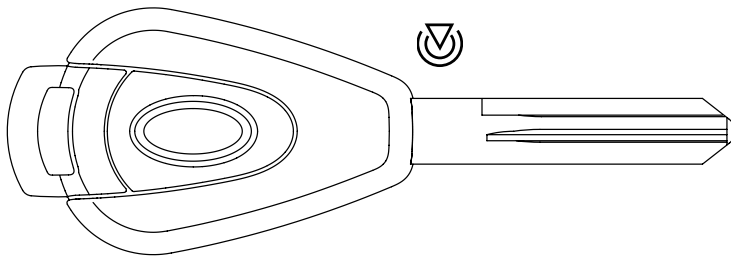

ILCO
EZ

SUB4-PT
-



GTH
(Head Only)

EB3-P-SUB4
(Blade Only)



SUB4-GTK
(Complete Key)

SUBARU

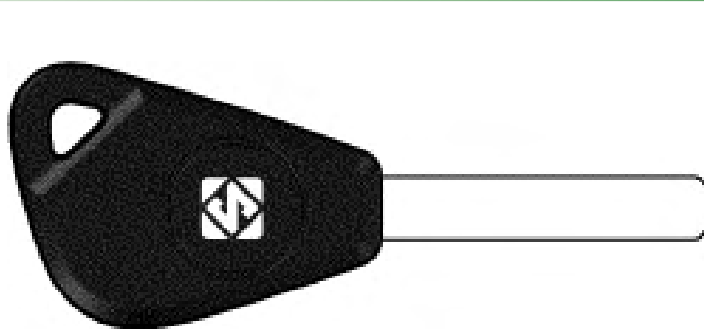

ILCO
EZ

SUB4FB
-



DAT17T13
-



DAT17-GTS
-

VEHICLE KEYS



SUBARU

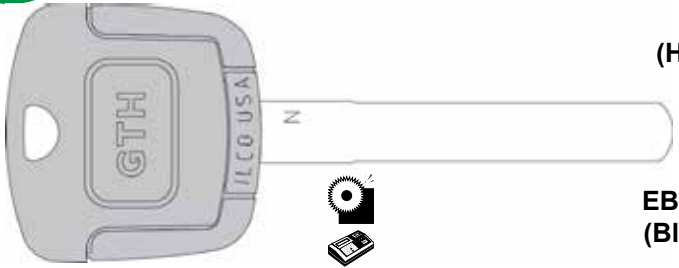

GTH
(Head Only)

EB3-N-SUB1
(Blade Only)

SUB1-GTK
(Complete Key)

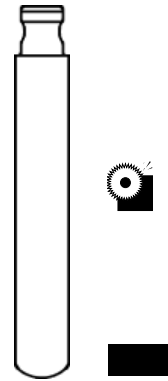

SUB1FB
-

ILCO
EZ

VEHICLE KEYS

SUBARU

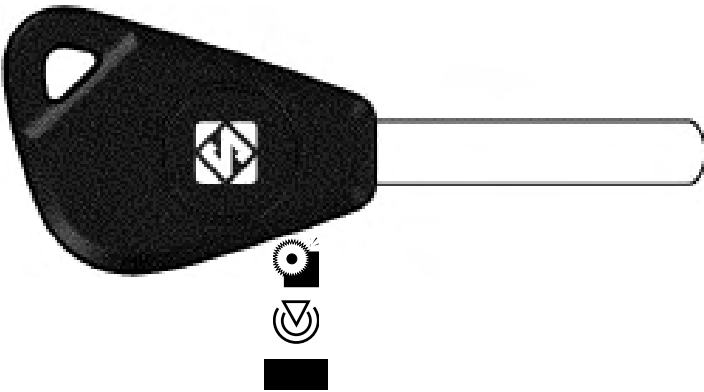

DAT17T42
-

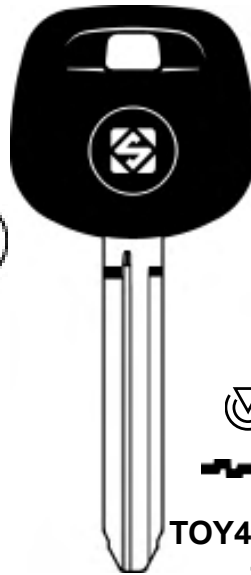

TOY43RT45
-

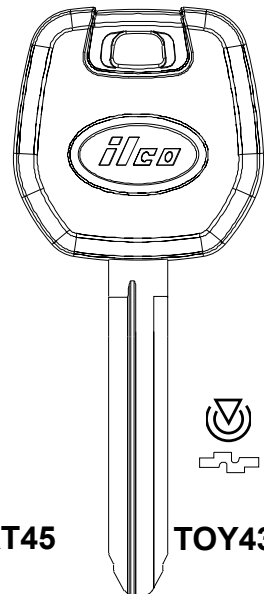

TOY43RH-PT ILCO
- **EZ**

SUBARU

SUNBEAM (See Roote Group also)



SUB1-3B
-



SUB4-3B

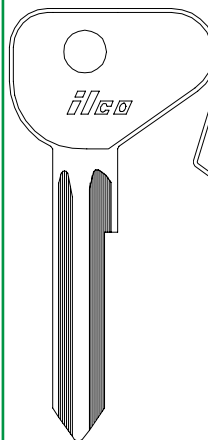

X1
MZ12

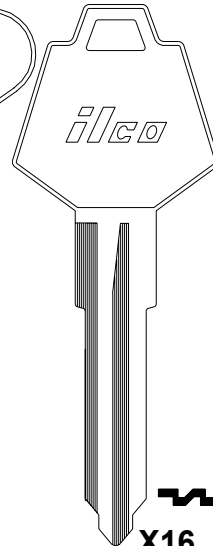

X16
P1771CR

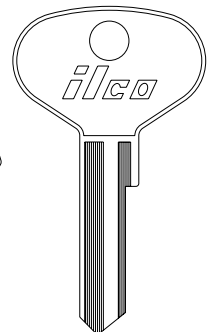

HR62DG ILCO
- **EZ**

SUZUKI AUTOMOBILES

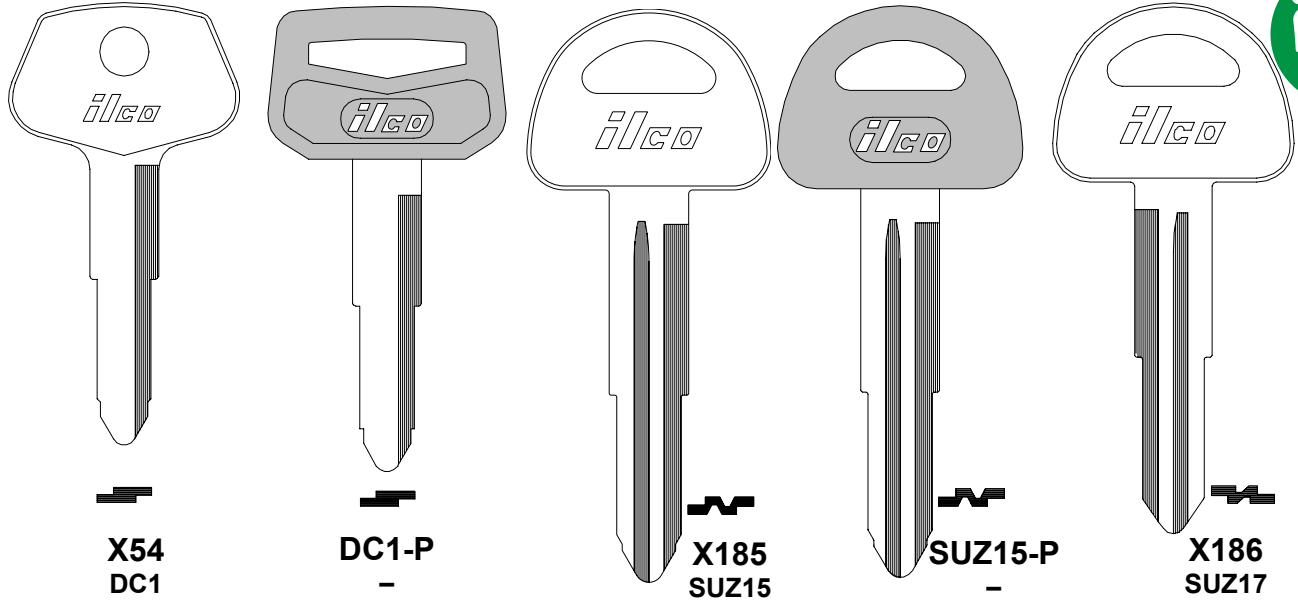

ILCO
EZ

X54
DC1

DC1-P
-

X185
SUZ15

SUZ15-P
-

X186
SUZ17

SUZUKI AUTOMOBILES

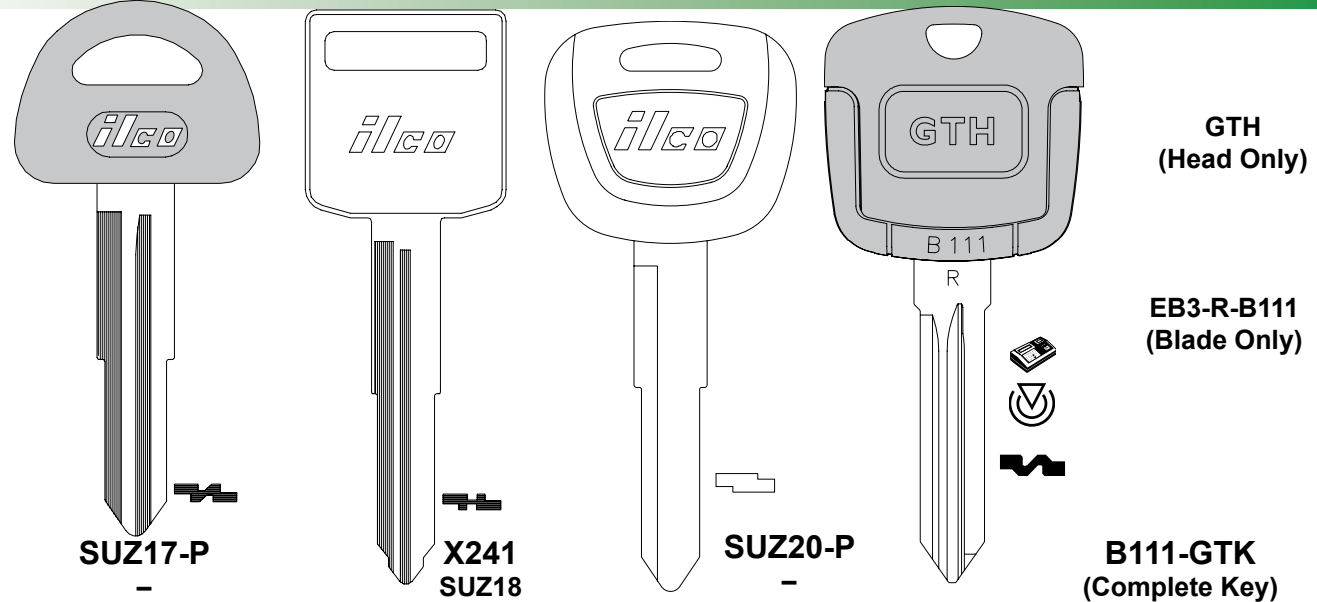

ILCO
EZ

SUZ17-P
-

X241
SUZ18

SUZ20-P
-

B111-GTK
(Complete Key)

GTH
(Head Only)

EB3-R-B111
(Blade Only)

SUZUKI AUTOMOBILES

SUZUKI MOTORCYCLES

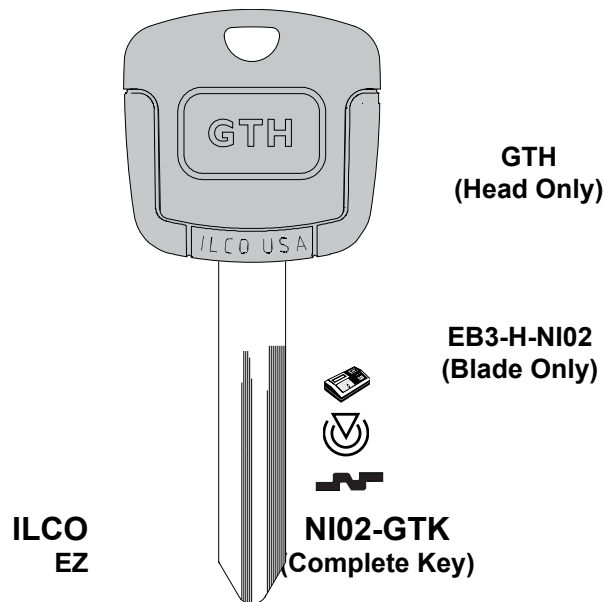

GTH
(Head Only)

EB3-H-NI02
(Blade Only)

ILCO
EZ

NI02-GTK
(Complete Key)

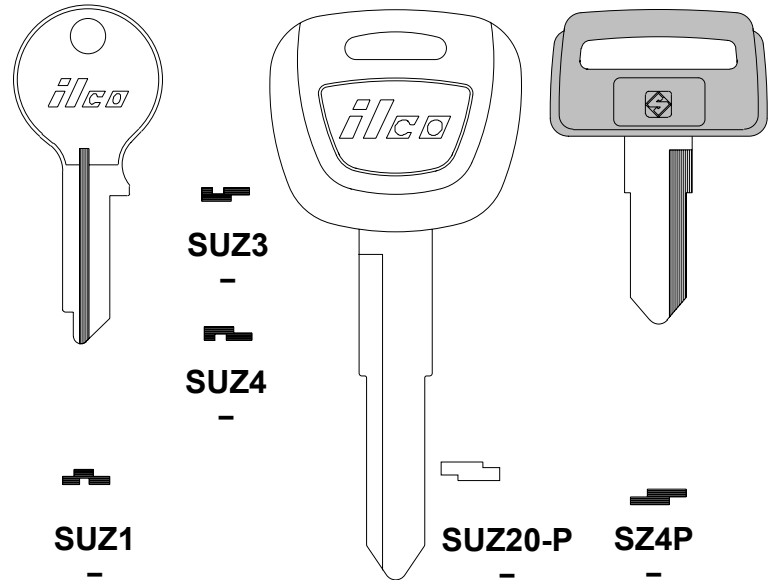

SUZ3
-

SUZ4
-

SUZ1
-

SUZ20-P
-

SZ4P
-





SUZUKI MOTORCYCLES

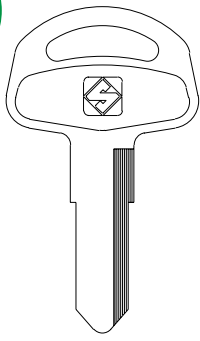

SUZ4R

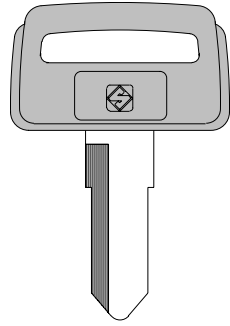

SUZ4RP

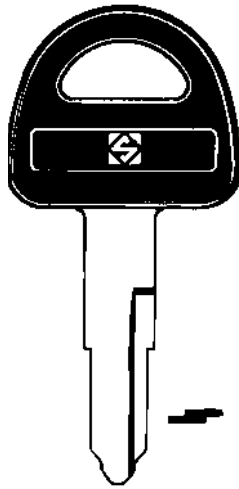

SUZ5P

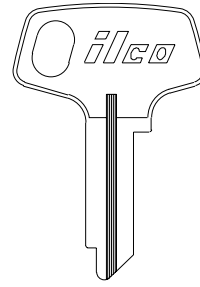

SUZ6

SUZ8

SUZ9



SUZ7

ILCO
EZ

SUZUKI MOTORCYCLES

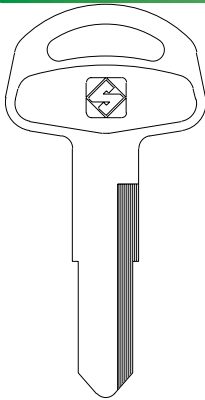

SZ9

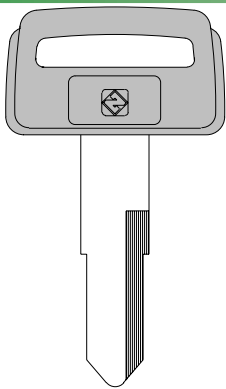

SZ9P

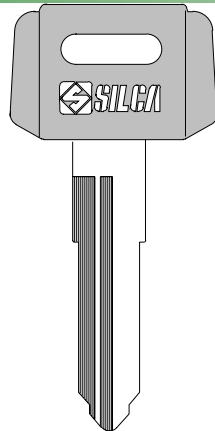

SZ10RP

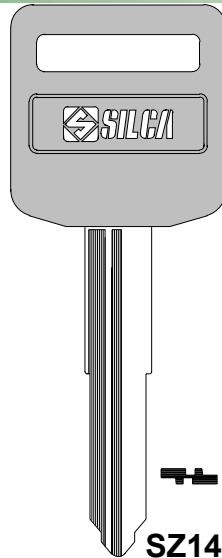

SZ14RAP

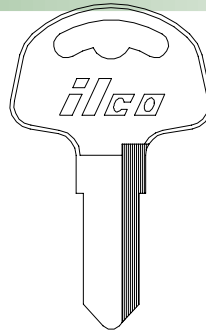

SUZ10

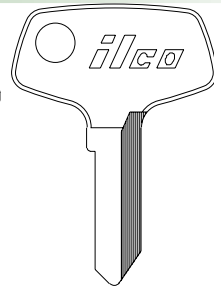

X11
SUZ5

ILCO
EZ

SUZUKI MOTORCYCLES

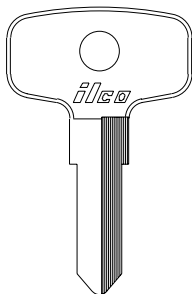

X25

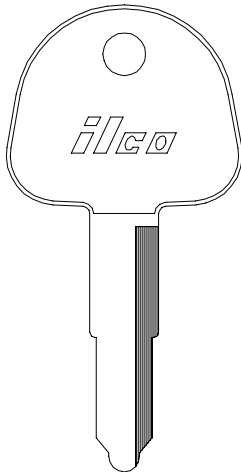

X87
SUZ11

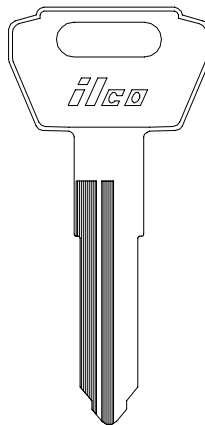

X179
SUZ12

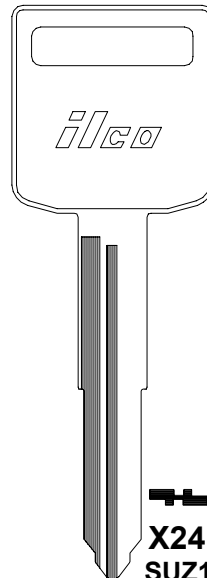

X241
SUZ18

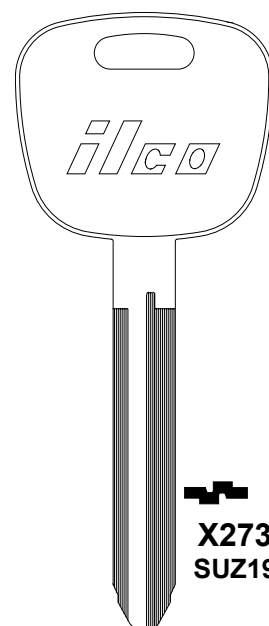

X273
SUZ19

ILCO
EZ



SUZUKI MOTORCYCLES

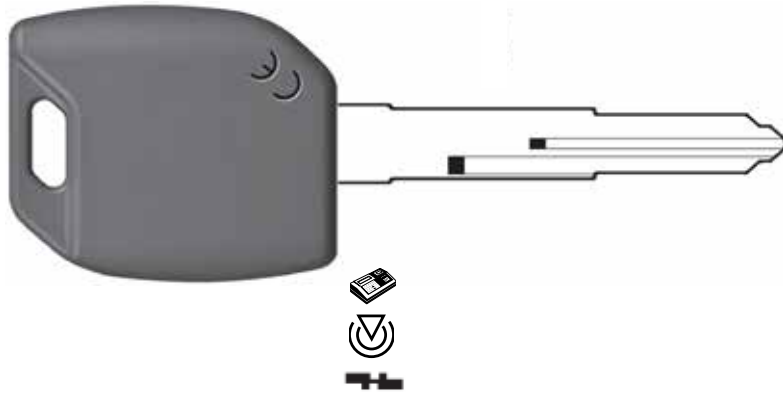

ILCO
EZ



SZ17RMH
-

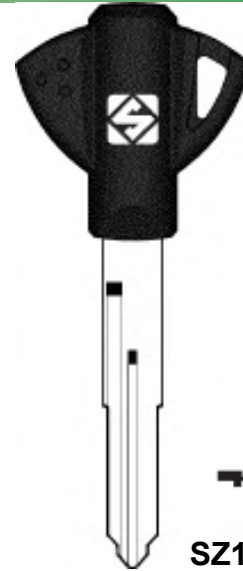

SZ17-GTS
-

SUZUKI MOTORCYCLES



ILCO
EZ

N2M
SR61N

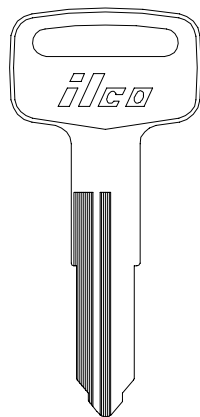

X117
YH48

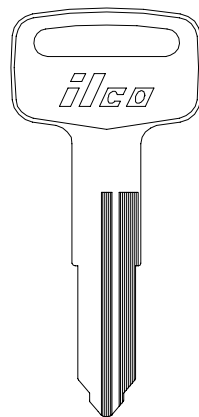

X118
YH49

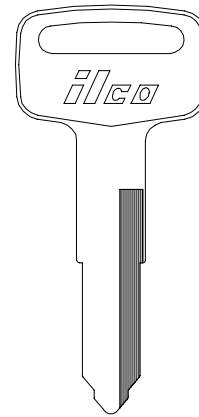

X119
YH47

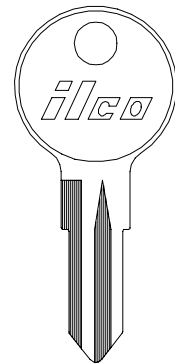

X226
HYD12

SUZUKI MOTORCYCLES

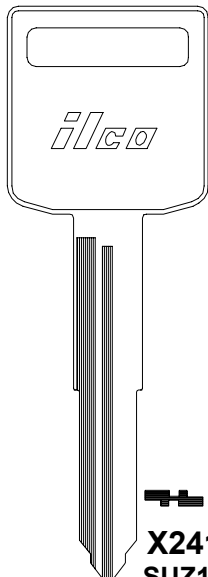

ILCO
EZ

X241
SUZ18

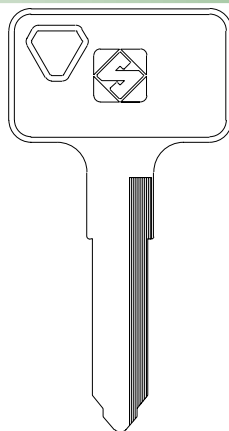

X259
KW14

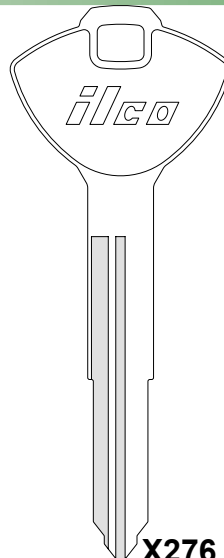

X276
SUZ16

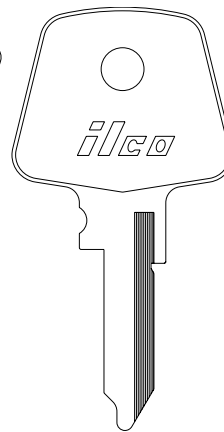

Y16
-

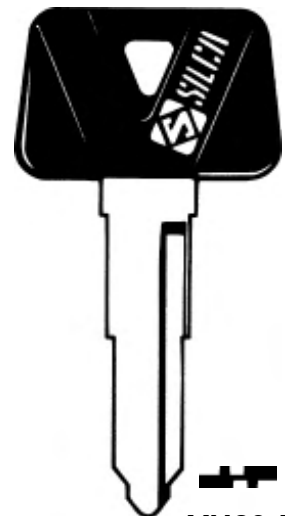

YH29-P
-



SUZUKI MOTORCYCLES



YH29RP-SI

-

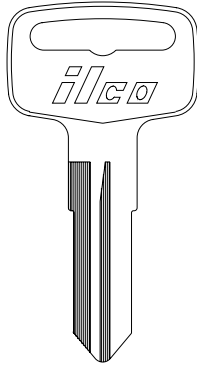

YH34

-



YH35

-

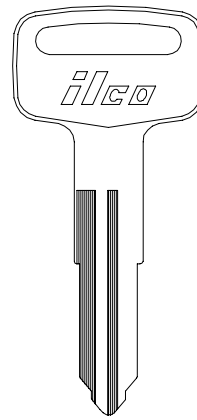

YH50

-

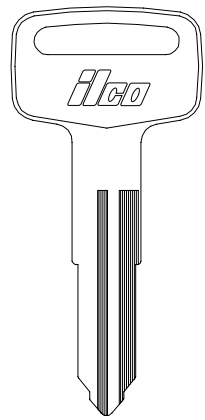

YH51
Y14

ILCO
EZ

VEHICLE KEYS

SUZUKI MOTORCYCLES

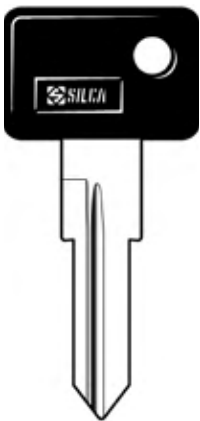

ZD16RP-SI

-



ZD24RDP-SI

-

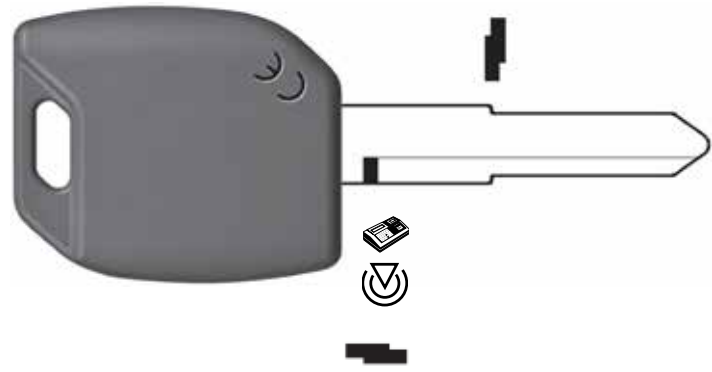

HU133RMH

-

ILCO
EZ

SUZUKI MOTORCYCLES

SWEDISH CAMP CAR

TAUNUA

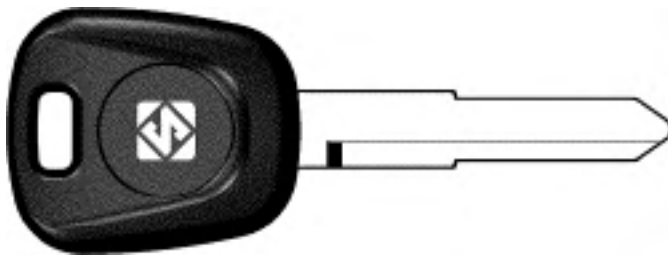

HU133R-GTS

-

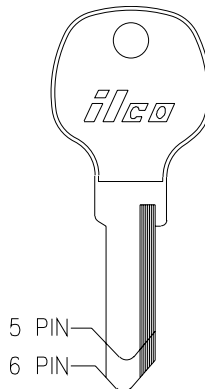

5 PIN
GH3

-

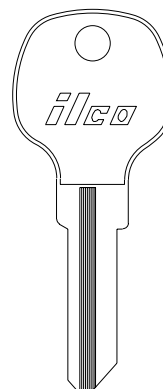

6 PIN
GH1

GH2

SEE
FORD
INTERNAT'L

ILCO
EZ

TEMPO

TITAN



VEHICLE KEYS

SEC 1
PG 191

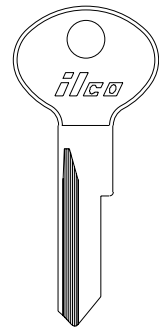
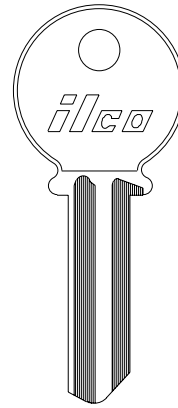
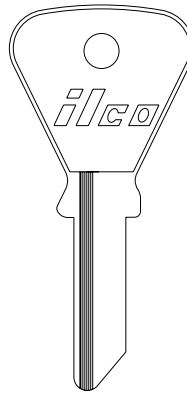
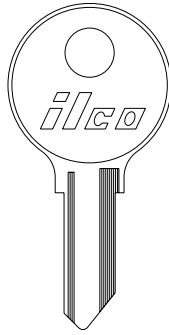
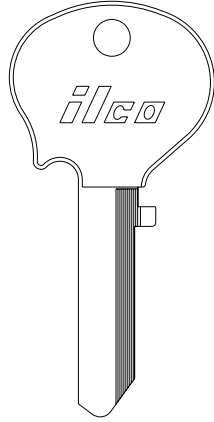
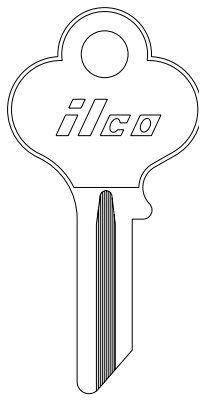

ILCO
EZ

FV1
-

NE7
-

62VA
-

62VH
-

62L
-

TT1
-

TITAN

TOOL BOX

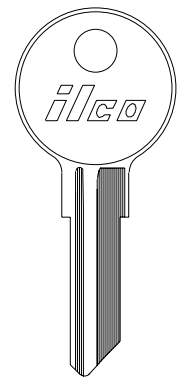
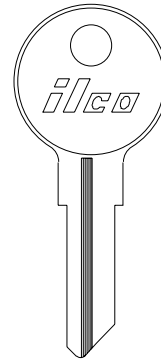
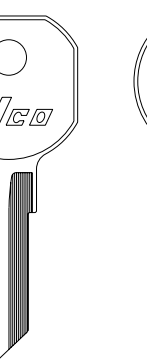
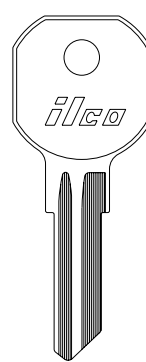
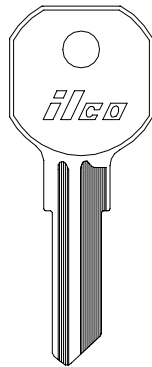
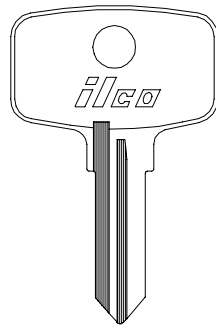
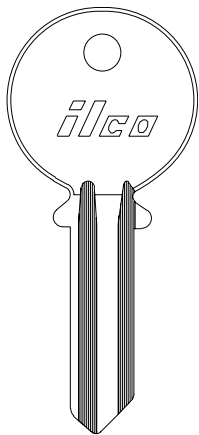

ILCO
EZ

TT91
-

1527
-

1529
-

1536
-

1536R
-

1557
-

1565
-

TOOL BOX

TOYOTA

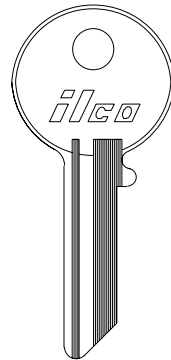
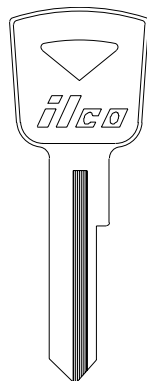
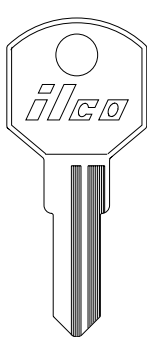
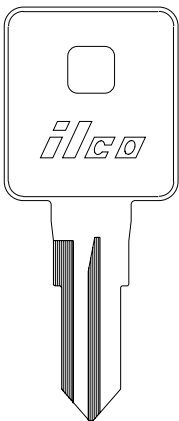

TP2

TP3

-

-



TP5

TP6

-

-



ILCO
EZ

1605
-

1620
-

TA1
-

TA14
-

TP1
-

TP4
-





TOYOTA

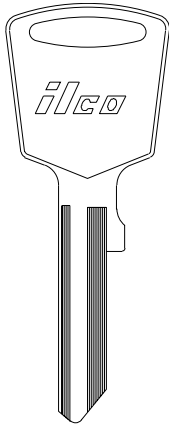

TA2 TA12
- -

TA4
-
TA11
-

TA5
-
TA16
-

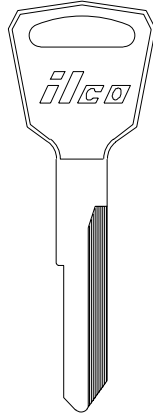

TA6 TA8
- -

TR18
TA7

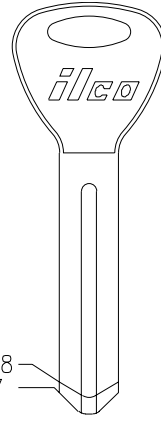

TA7 TR18
- -

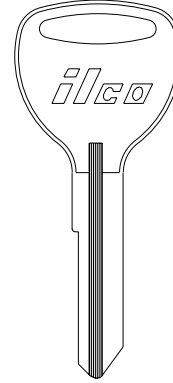

TA9
-

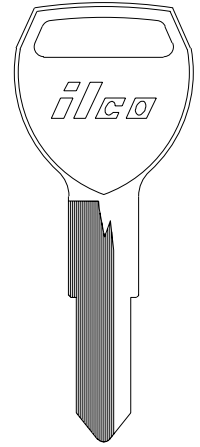

TA15 ILCO
- EZ

VEHICLE KEYS

TOYOTA

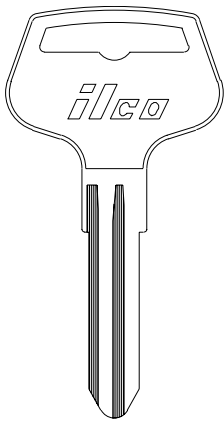

TA19
-

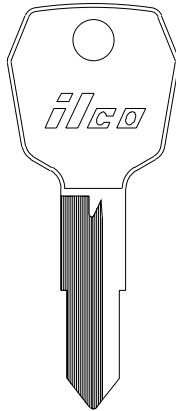

TA23
-

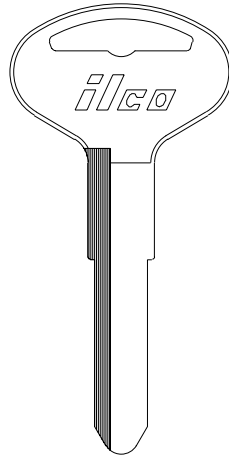

TA24
-

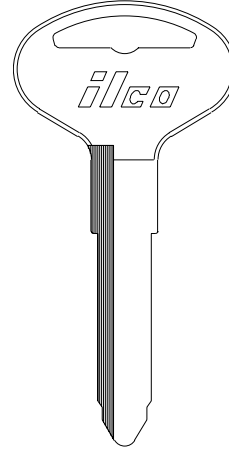

TA25
-

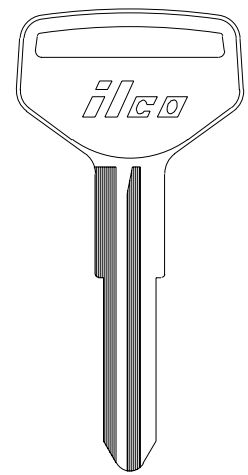

TR25 ILCO
- EZ

TOYOTA

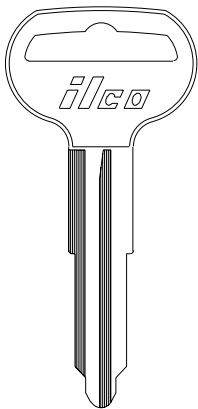

TA26
-

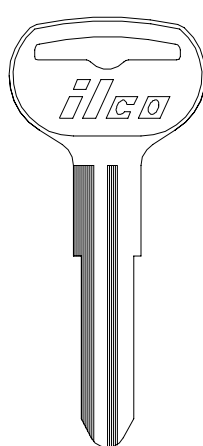

TR26
-

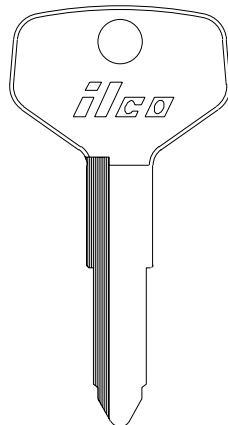

TA28
-

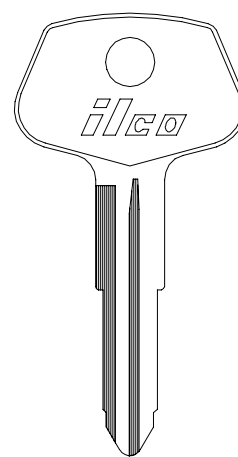

X37
TR28

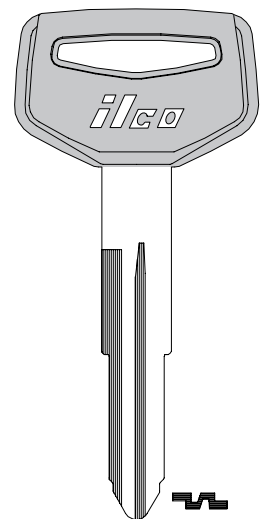

TR28-P ILCO
- EZ

TOYOTA

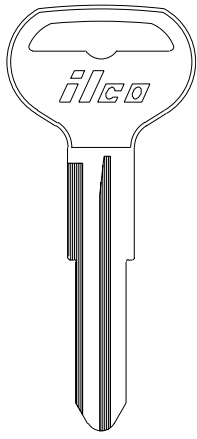

ILCO
EZ

X46
TA27

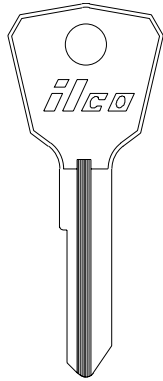

T61A T61B
- -

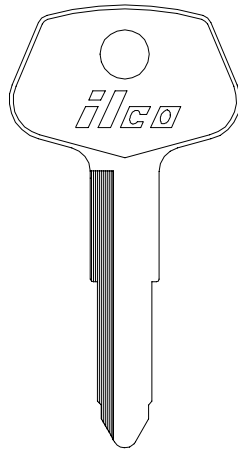

T61C
-

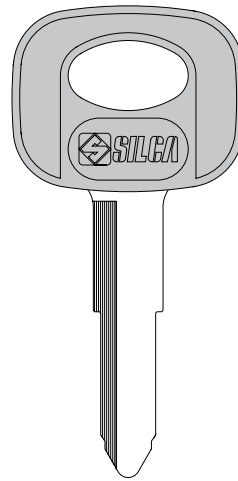

T61C-P
-

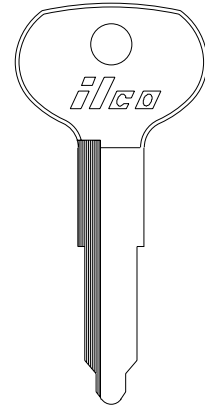

T61D X45
- TA21

TOYOTA

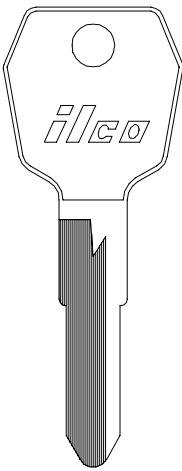

ILCO
EZ

T61F
-

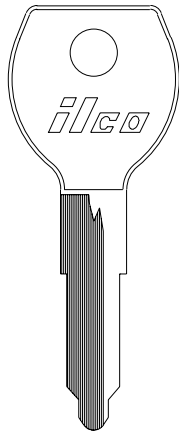

T61E
-

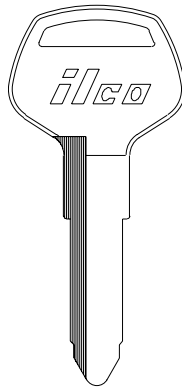

T61G
-

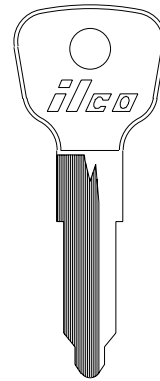

T80J
-

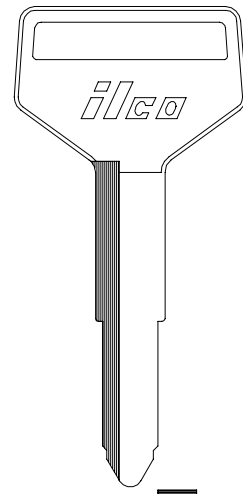

ILCO
EZ

X137
TR33

TOYOTA

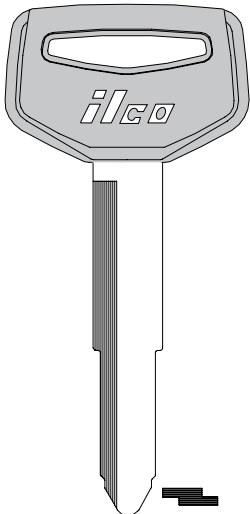

ILCO TR33-P (-PC)
EZ -

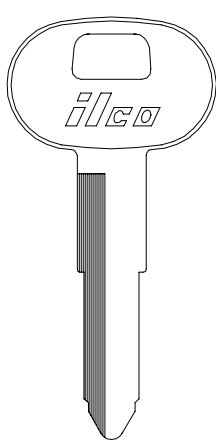

X146
B56

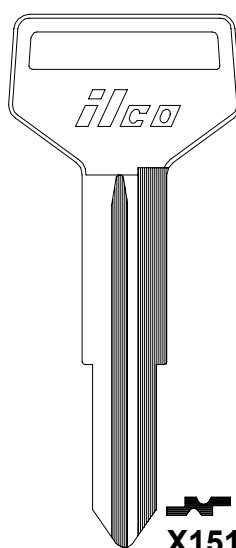

X151
TR39

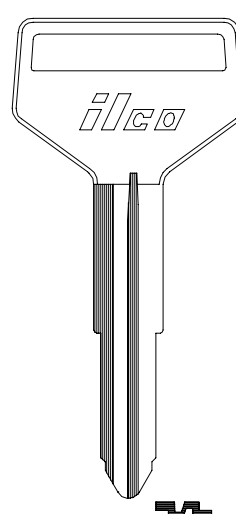

X159
TR37

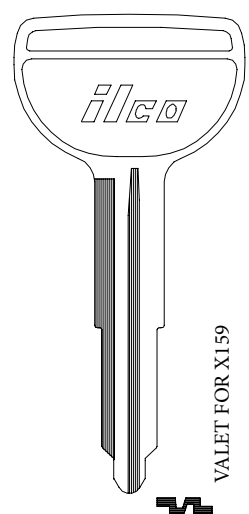

X218
TR49

VALET FOR X159





TOYOTA

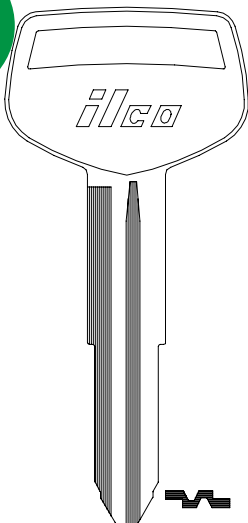

X174
TR40

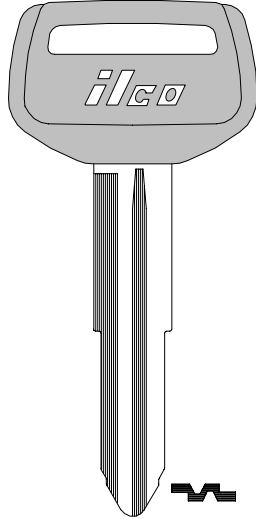

TR40-P (-PC)

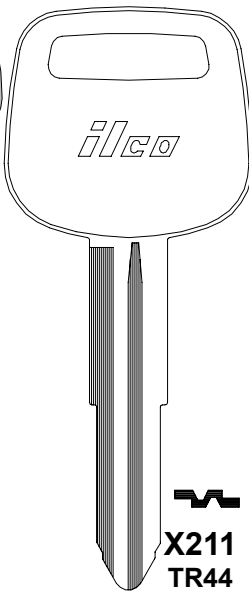

X211
TR44

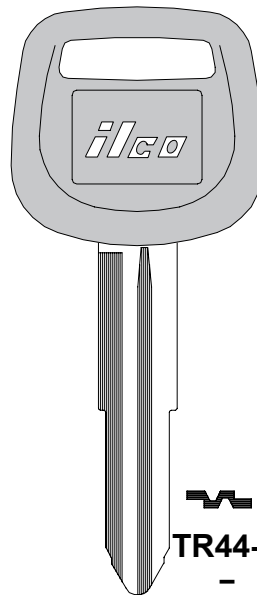

TR44-P

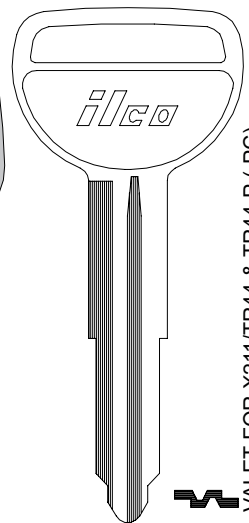

X219
TR48

VALET FOR X211/TR44 & TR44-P (-PC)

ILCO
EZ

VEHICLE KEYS

TOYOTA

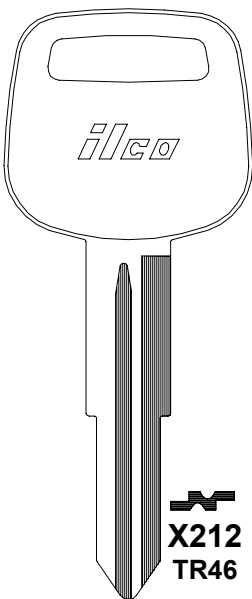

X212
TR46

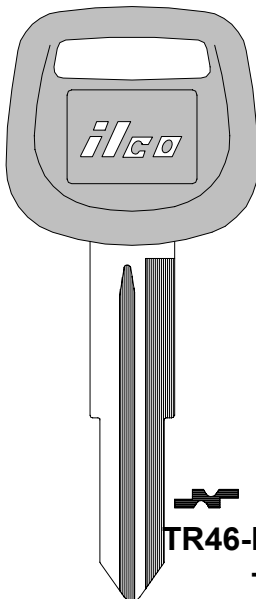

TR46-P (-PC)

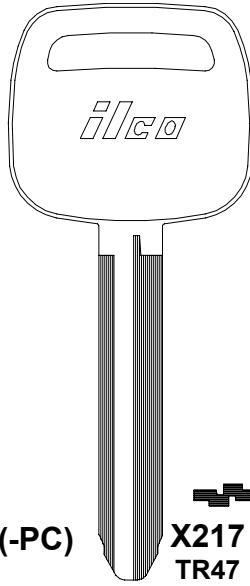

X217
TR47

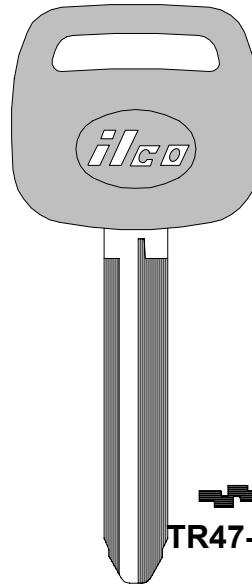

TR47-P (-PC)

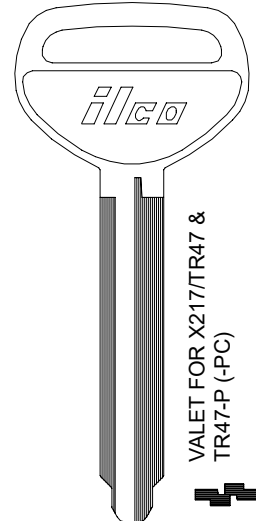

X220
TR50

VALET FOR X217/TR47 & TR47-P (-PC)

ILCO
EZ

TOYOTA

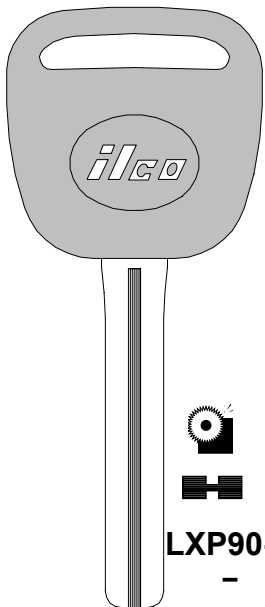

LXP90-P

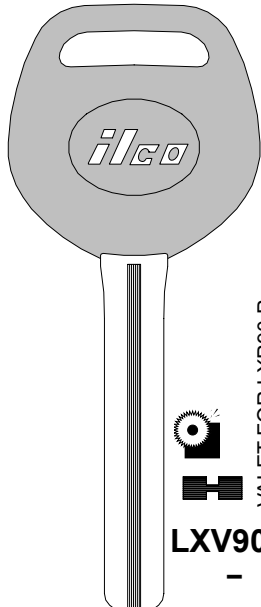

LXV90-P

VALET FOR LXP90-P

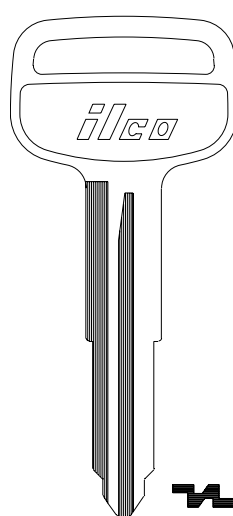

X223
TR53

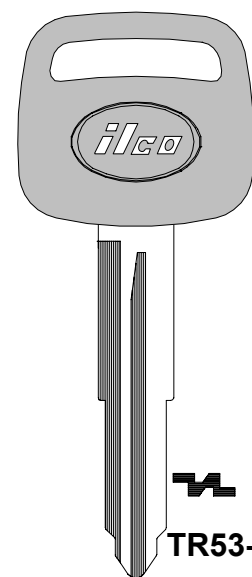

TR53-P

ILCO
EZ

TOYOTA

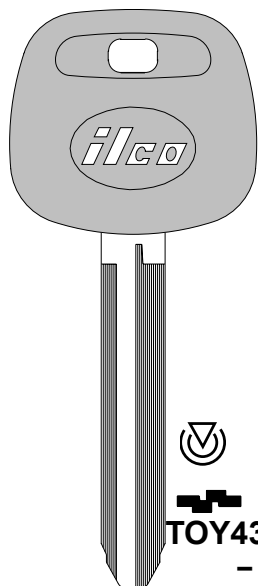

ILCO
EZ

TOY43AT4
-



GTH
(Head Only)

EB3-E-TOY43
(Blade Only)



TOY43-GTK
(Complete Key)

TOYOTA

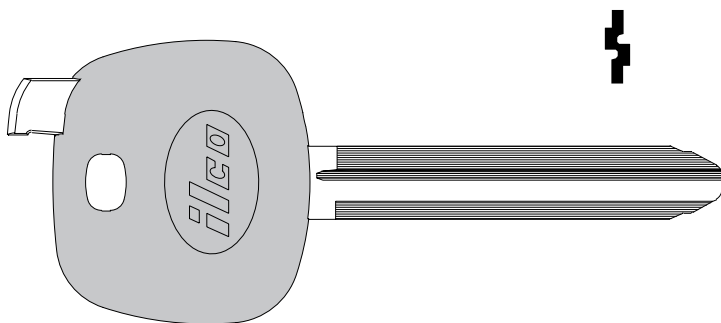

ILCO
EZ

TOY43-GTS
-

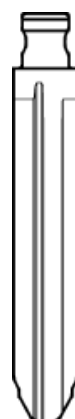

TOY43FB
-

TOYOTA

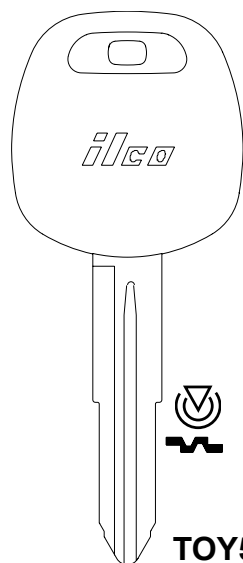

ILCO
EZ

TOY57-PT
-

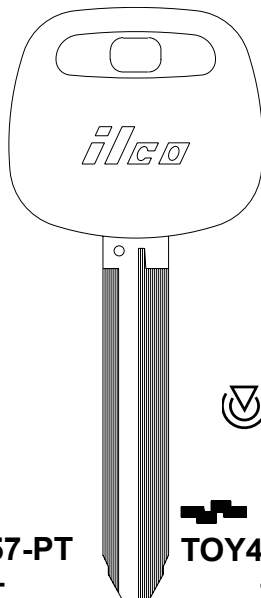

TOY44D-PT
-

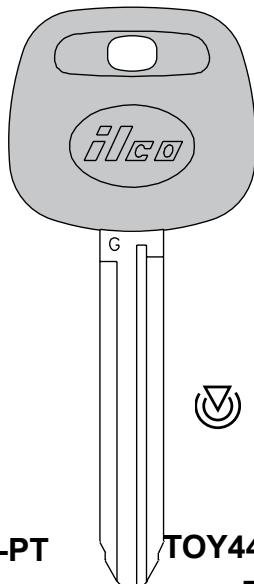

TOY44G-PT
-

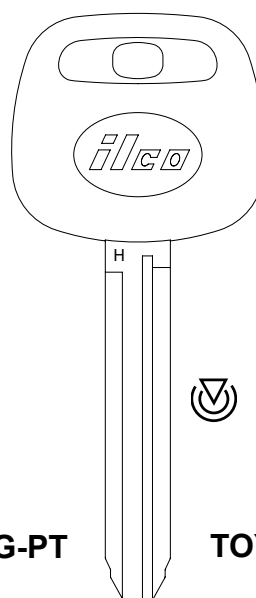

TOY44H-PT
-





TOYOTA

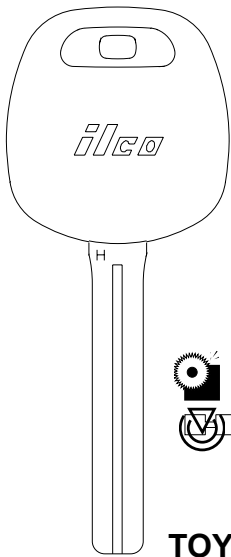

TOY48H-PT
-



TOY40-GTK
(Complete Key)

GTH
(Head Only)

EB3-G-TOY40
(Blade Only)

ILCO
EZ

VEHICLE KEYS

TOYOTA



TOY40-GTS
-



TOY48-GTK
-

GTH
(Head Only)

EB3-F-TOY48
(Blade Only)

ILCO
EZ

TOYOTA



TOY48-GTS
-



TOY48 EMER. THIN
-

ILCO
EZ

TOYOTA

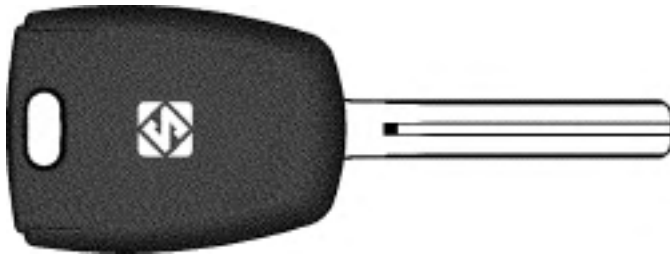

ILCO
EZ

TOY49TE-GTS
-

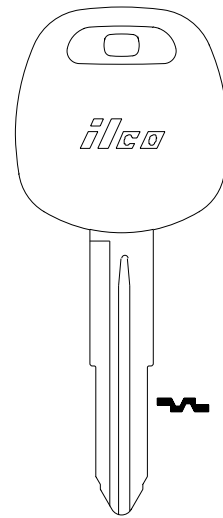

TOY51-P
-

TOYOTA



ILCO
EZ

TOY-3B
-



TOY-4B
-



TOY-4B2
-

TRABANT

TRIUMPH

TRIUMPH MOTORCYCLE

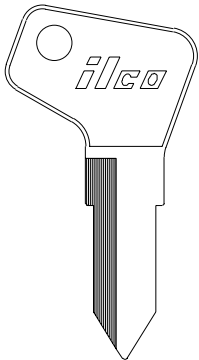

**SEE
BRITISH
LEYLAND**

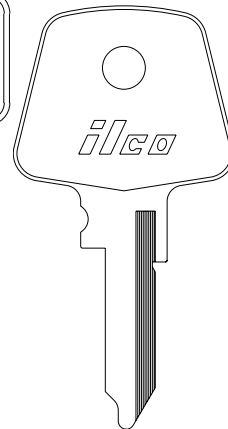
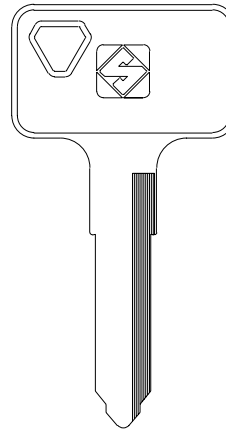
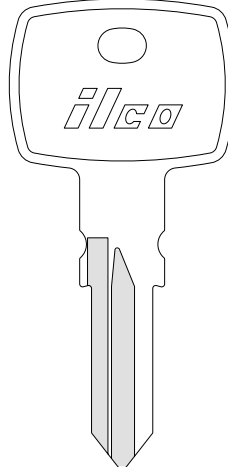

ILCO DB1
EZ -

DB2
-

X270
TMC1

X259
KW14

Y16
-





TRIUMPH MOTORCYCLE

VAN GUARD

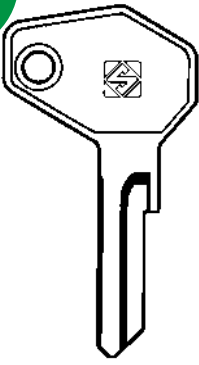

ZD7-SI
-



ZD24RDP-SI
-

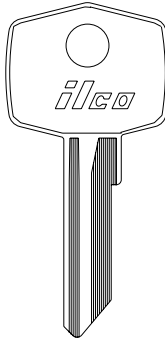

62FS
-



R62DM
-

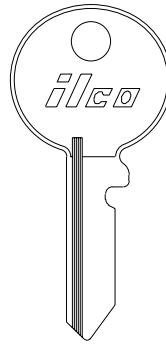

62DP
-

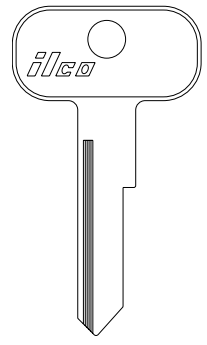

H62DP H62DR
ILCO EZ

VEHICLE KEYS

VAUXHALL

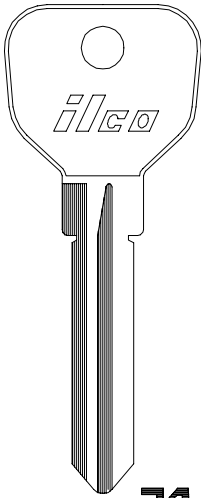

MG1
-

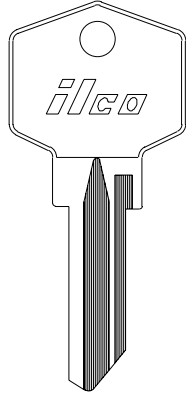

UN1
-

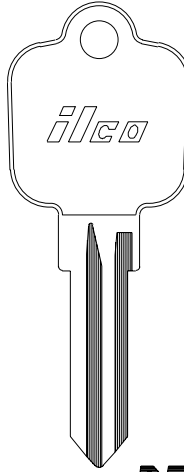

CE2
-

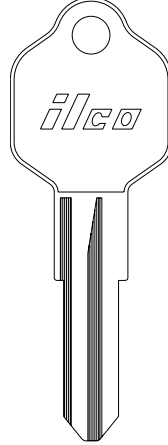

CE3
-

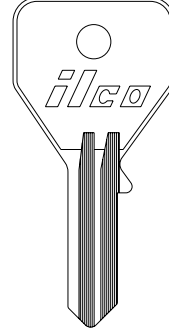

BR5
-

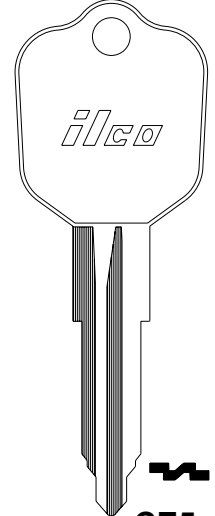

CE5 ILCO
EZ

VAUXHALL

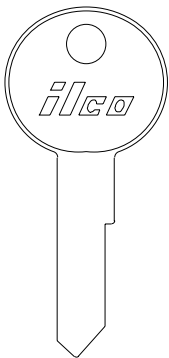

LF5
-

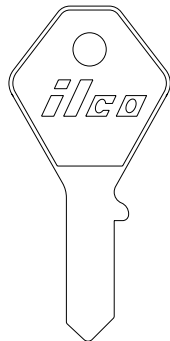

BR7
-

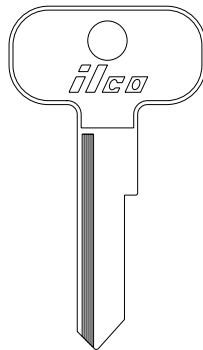

BR9
-

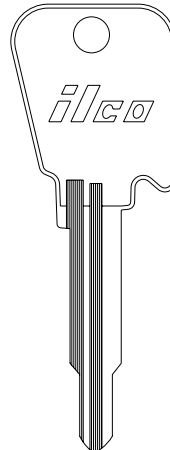

X13
LF4

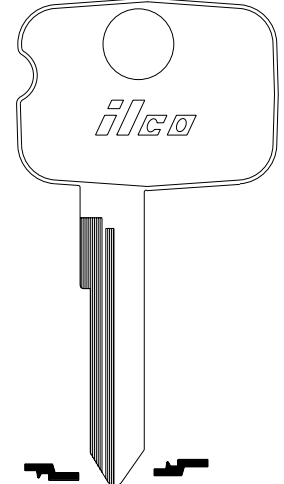

YM29 YM30
-

ILCO
EZ





VAUXHALL

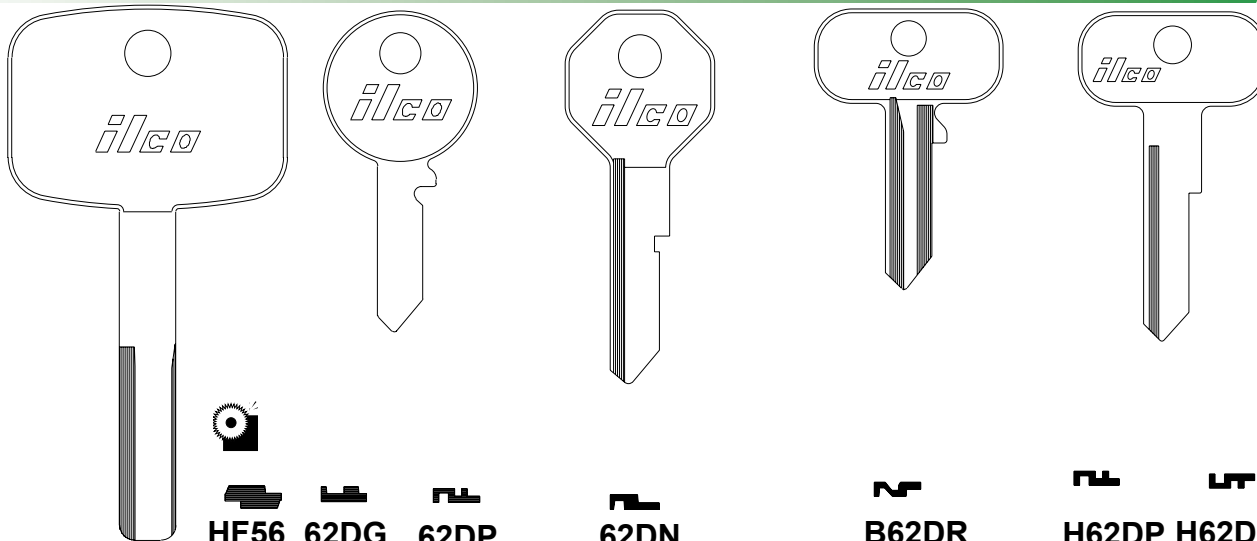

ILCO
EZ



HF56



62DG



62DP



62DN



B62DR



H62DP



H62DR

VAUXHALL

VESPER

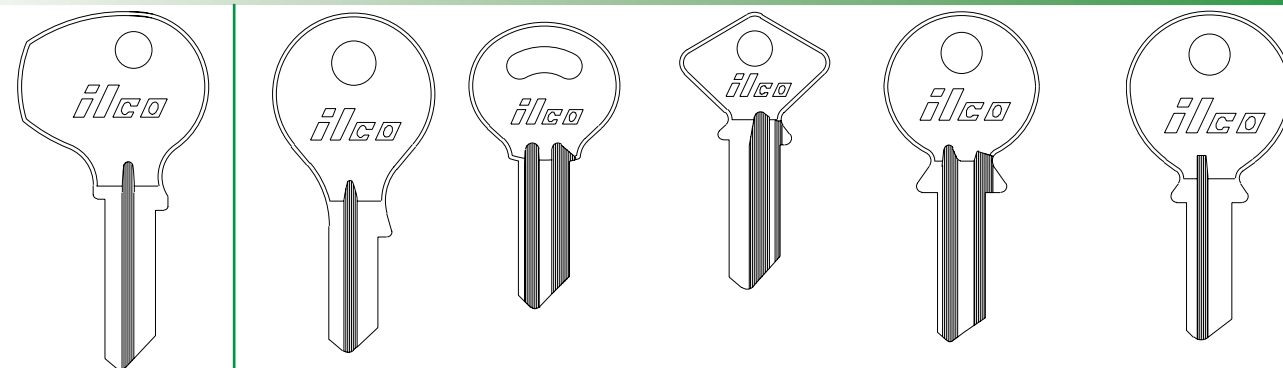

ILCO
EZ



64K



DO1S



VS1



VS3



VE4



VE5



VE6

VESPER

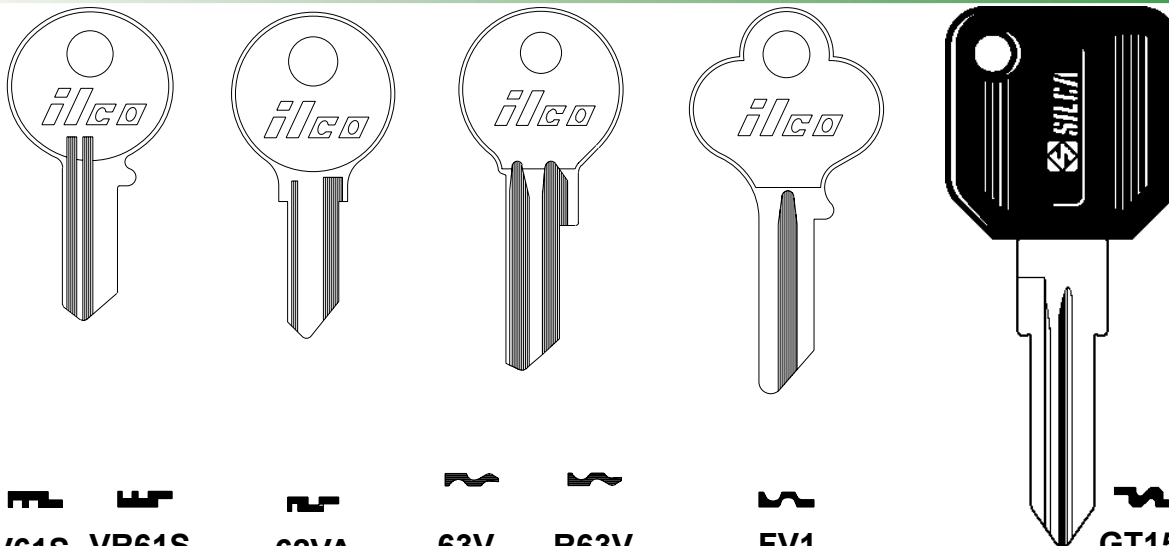

ILCO V61S VR61S
EZ - -

62VA

63V

R63V

FV1

GT15RAP-SI





VESPER

VICTORY

VIKING



GT15RDT5-SI

-

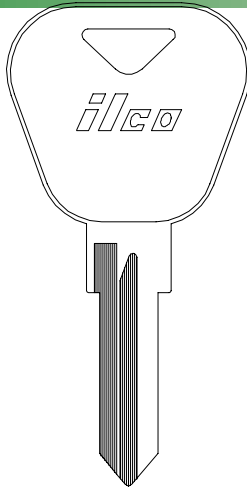

X167
YU2

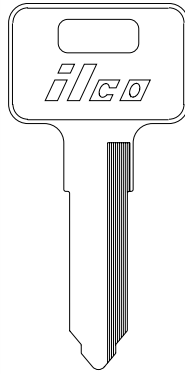

X259
KW14

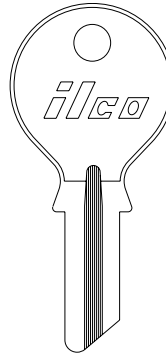

63

-

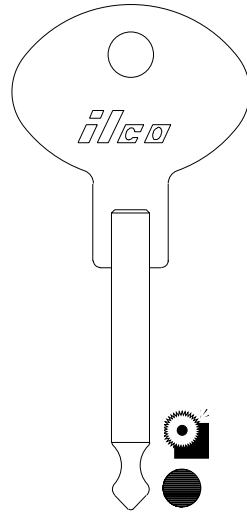

138

-



ILCO
EZ

VEHICLE KEYS

VOLKSWAGEN

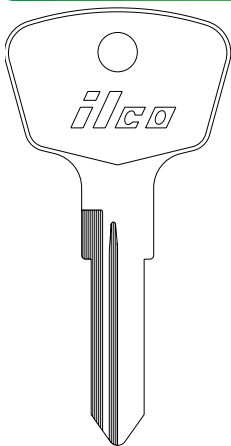

AD1

-

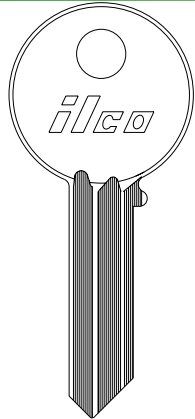

BKZ1

-

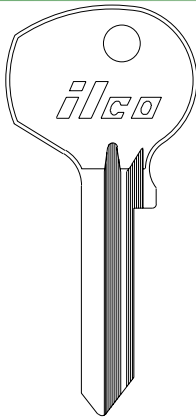

KP1

-

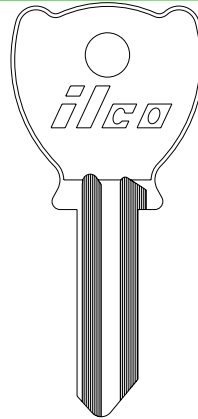

BT2

-

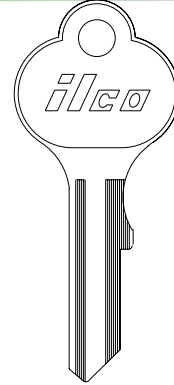

VW1

-

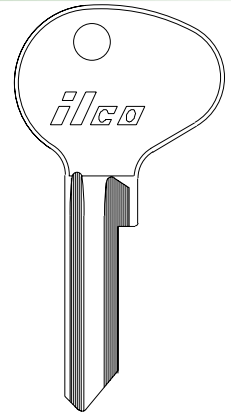

VW1CZ

-



ILCO
EZ

VOLKSWAGEN

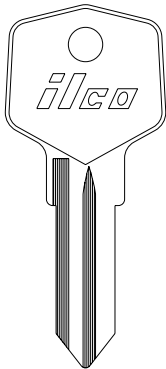

CA2

-

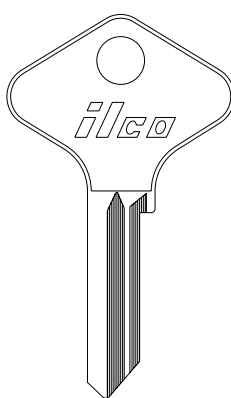

DM2

-

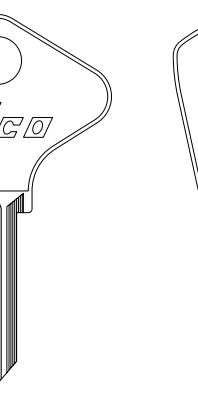

DM3

-

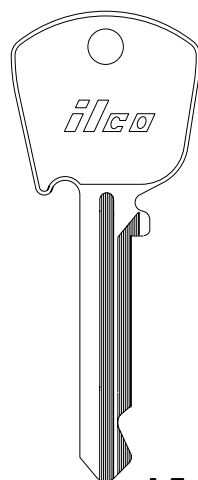

FT3

-

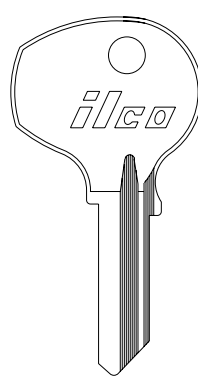

DM4

-

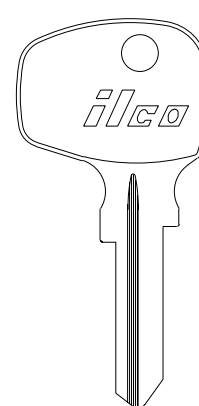

MB5

-

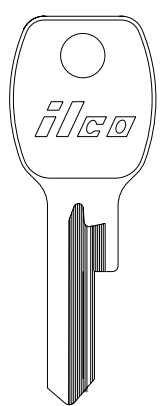

WS5

-



ILCO
EZ

SEC 1

PG 200



VOLKSWAGEN

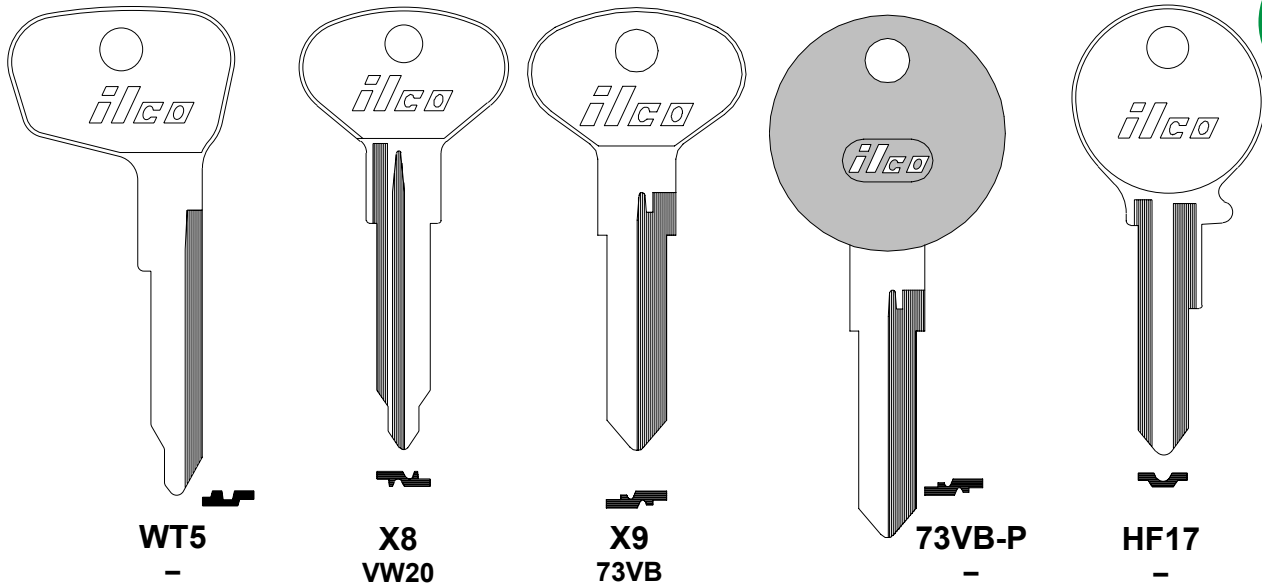

ILCO EZ	WT5 -	X8 VW20	X9 73VB	73VB-P -	HF17 -
------------	----------	------------	------------	-------------	-----------

VOLKSWAGEN

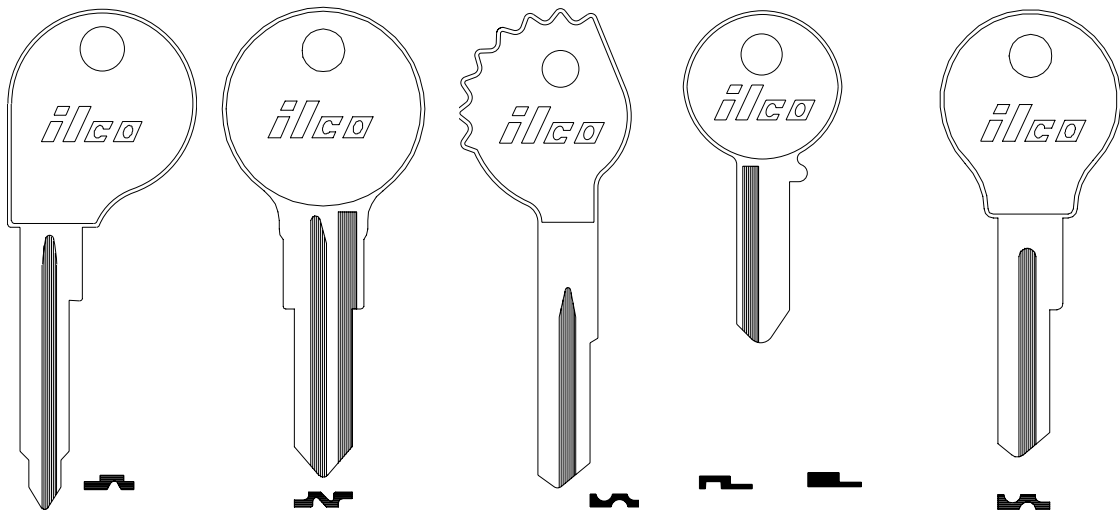

ILCO EZ	HF35 -	X53 V32	OP60C -	61N -	61NC -	61VW -	U61VW -	V61VW -
------------	-----------	------------	------------	----------	-----------	-----------	------------	------------

VOLKSWAGEN

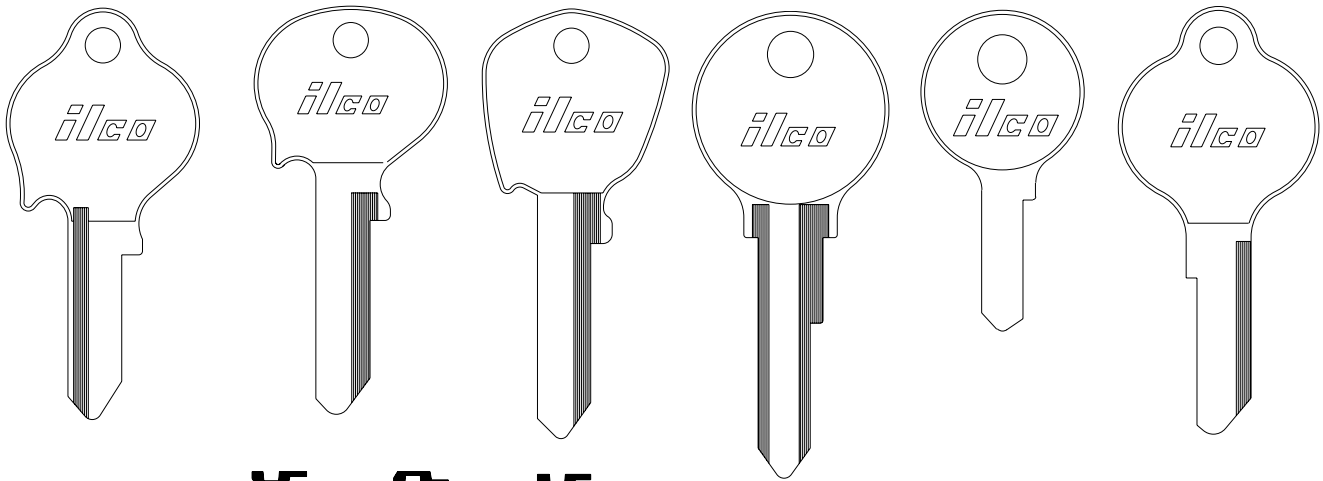

ILCO EZ	H61VM -	H61VR -	FT12R -	T61VR -	62DW -	62VC -	62VE -
------------	------------	------------	------------	------------	-----------	-----------	-----------

VEHICLE KEYS





VOLKSWAGEN

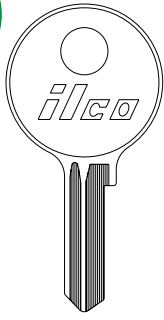

62VG

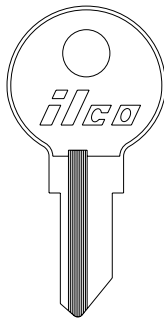

62VO

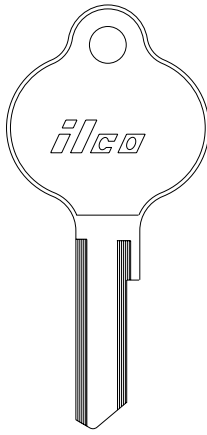

62VW

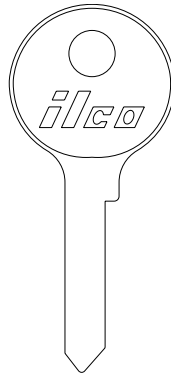

A62VC

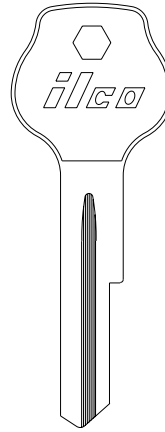

A62VN

L62VB HR62VK

**ILCO
EZ**

VEHICLE KEYS

VOLKSWAGEN

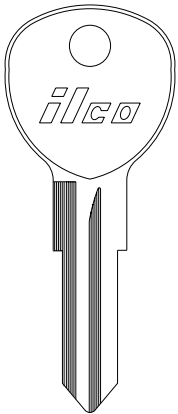

H62FD



HR62FD

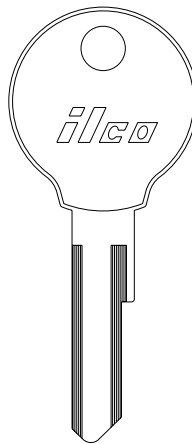

S62DW

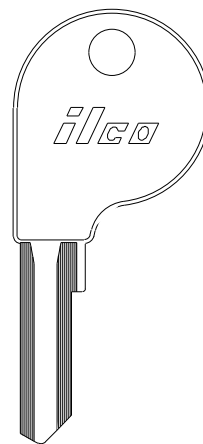

U62VB

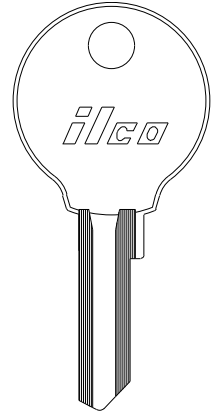

W62VB

**ILCO
EZ**

VOLKSWAGEN

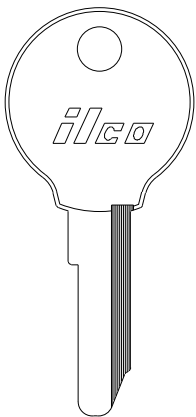

W62VE

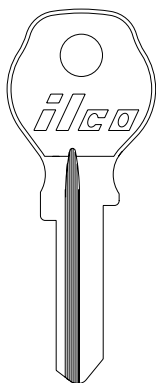

M63BG

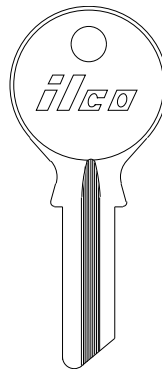

63L

A63L

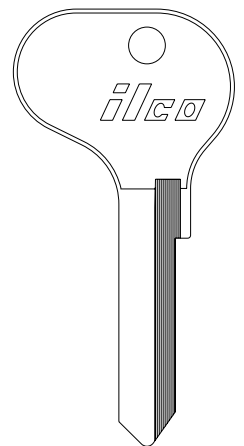

63VR

**ILCO
EZ**

VOLKSWAGEN

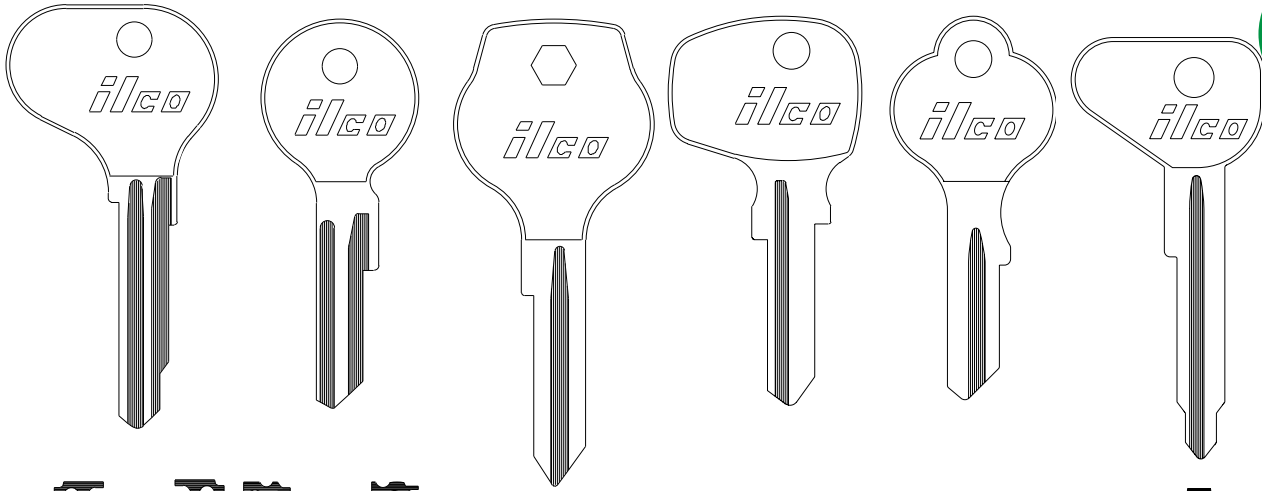

ILCO EZ	63VS	R63VS	63WG	R63WG	H63VO	S63B	U63H	V27 V78JK
-	-	-	-	-	-	-	-	-

VOLKSWAGEN



ILCO EZ	VW63	VW64	VW63A	64K	VW64T	VW67
-	-	V72N	-	-	-	-

VOLKSWAGEN

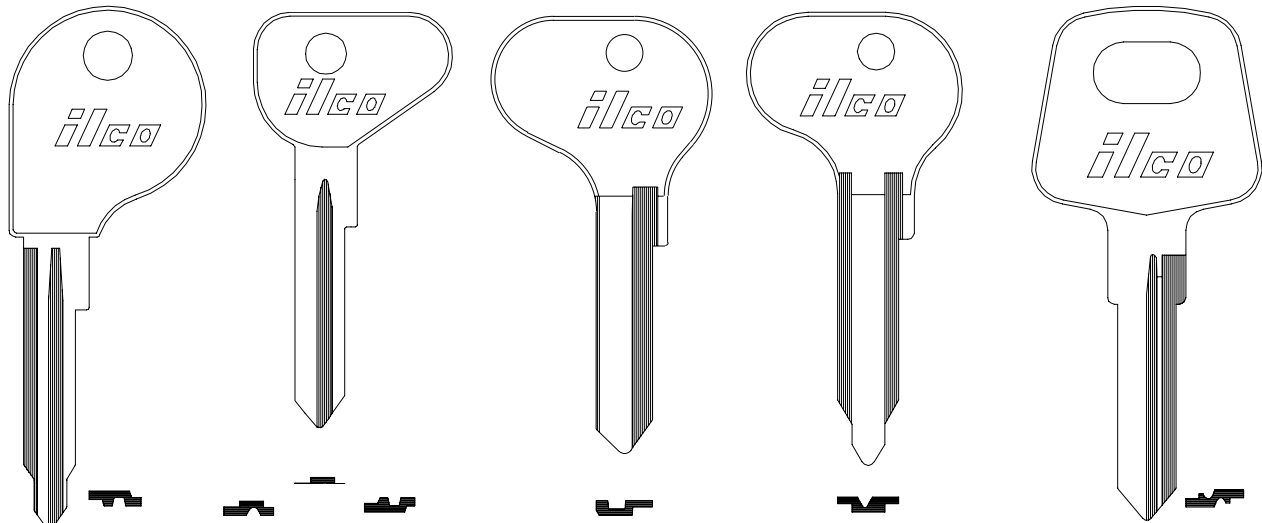

ILCO EZ	VW67S	VW71	VW71A	V72E	VW77	X88 PA8
-	-	-	-	-	-	-



VOLKSWAGEN

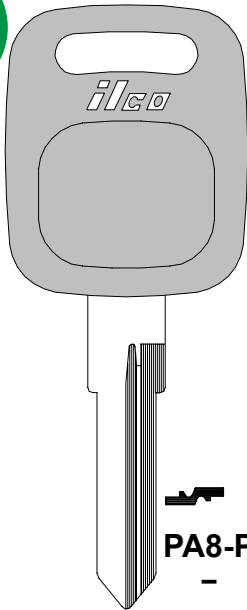

PA8-P
-

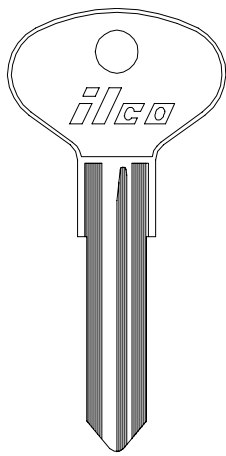

X110
V33

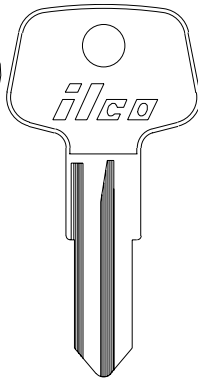

X132
-

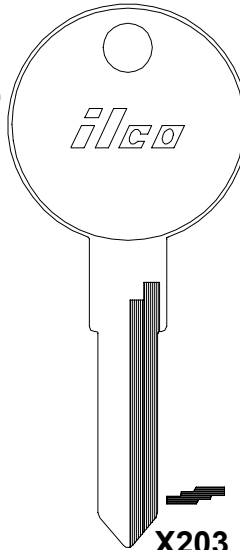

X203
V37

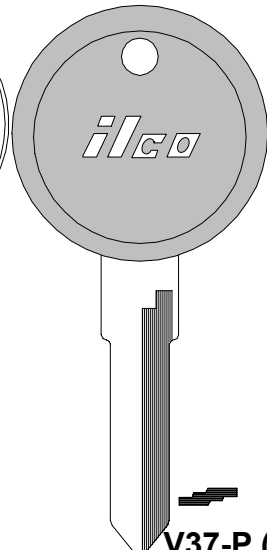

V37-P (-PC)ILCO
- EZ

VEHICLE KEYS

VOLKSWAGEN

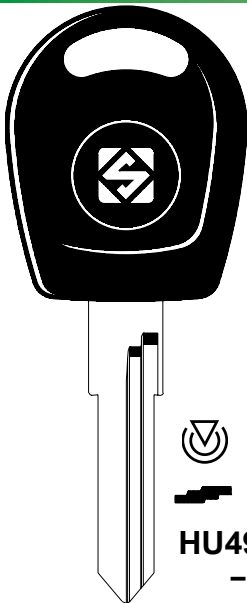

HU49T1
-

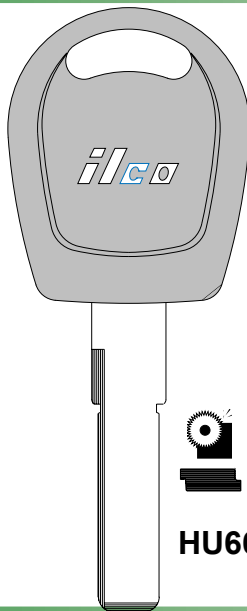

HU66-P
-

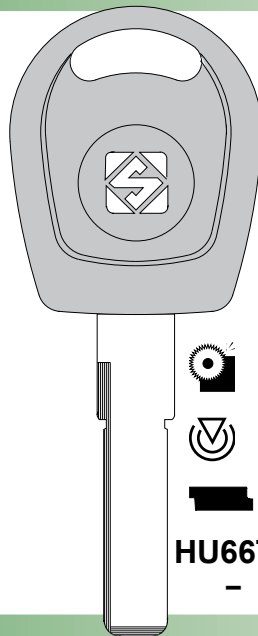

HU66T1
-

HU66T5
-
HU66T6
-
HU66T24
-
HU66T28
-
HU66T88
-

ILCO
EZ

VOLKSWAGEN



HU66-GTS
-

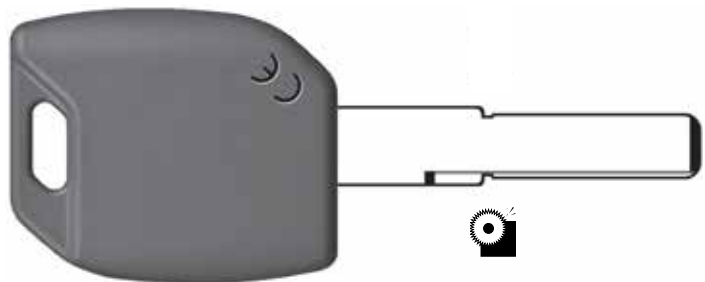

HU66MH
-

ILCO
EZ

SEC 1
PG 204



VOLKSWAGEN



HU66FB

ILCO
EZ

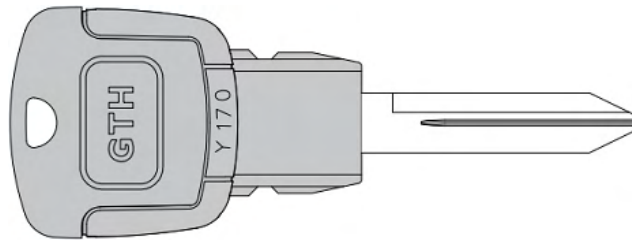

Y170-GTK

VOLKSWAGEN

VOLVO

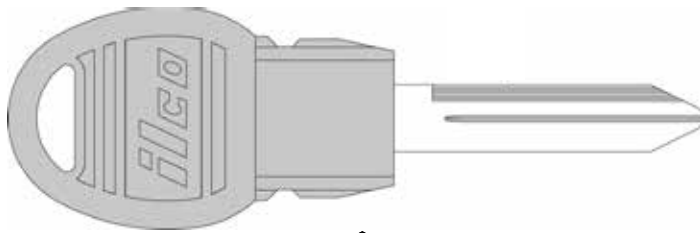

Y170-PT

ILCO
EZ

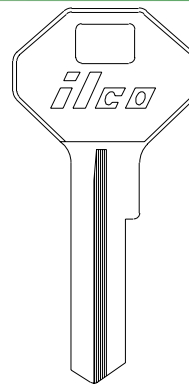

VL1

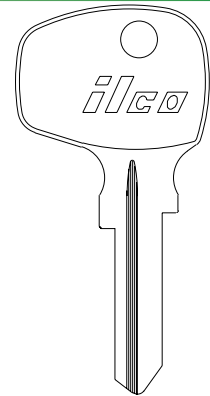

MB5

VOLVO

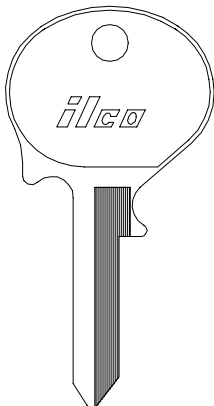

VO6
V77

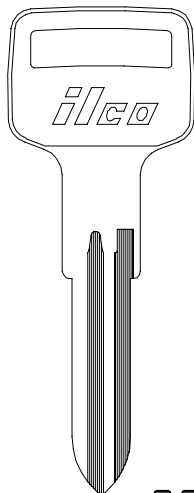

X29
V073

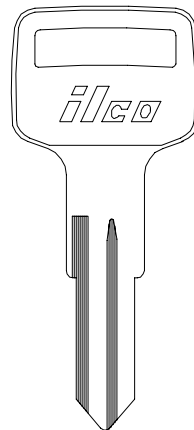

X30
V073S

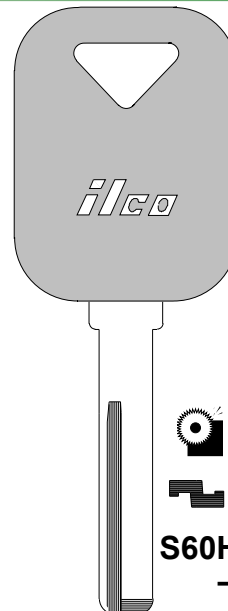

S60HF-P

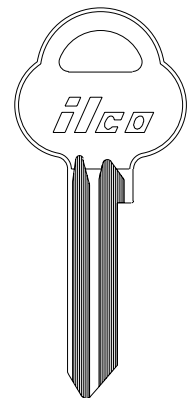

SR61W

ILCO
EZ





VOLVO

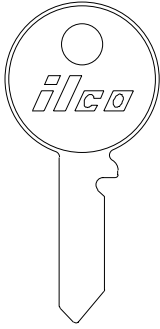

62DG
-

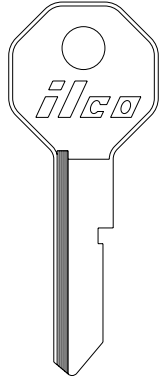

62DP
-

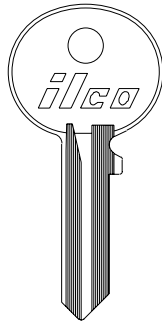

62DN
-

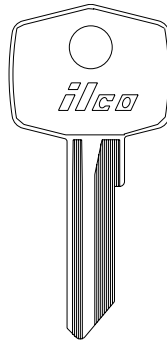

62DS
-

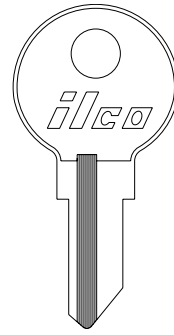

62FS
-

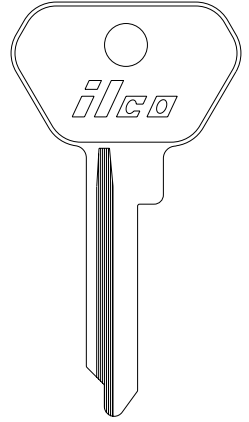

62VO
-

VO62
-

ILCO
EZ

VOLVO

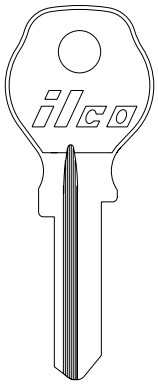

M63BG
-

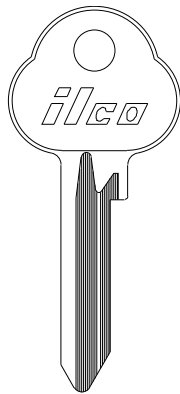

V61A
-

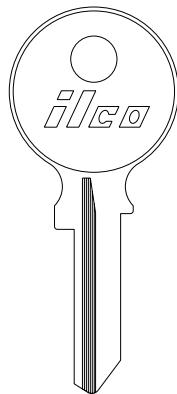

M63B
-

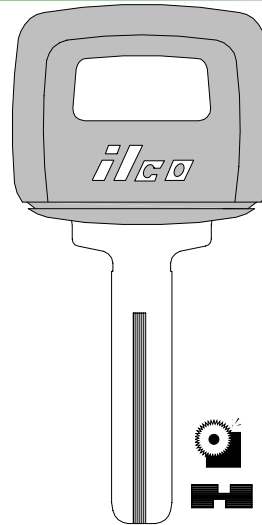

S66NN-P
-

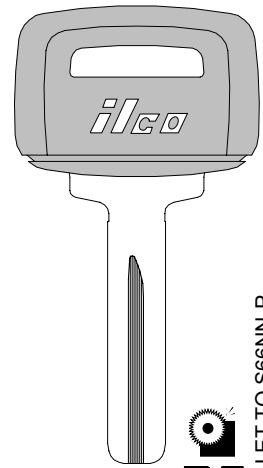

S67NN-P
-

ILCO
EZ

VOLVO

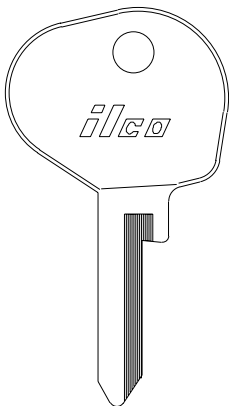

V80P
-

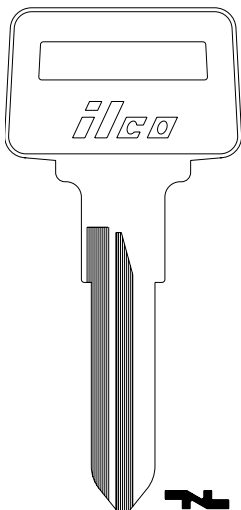

X80
VL6

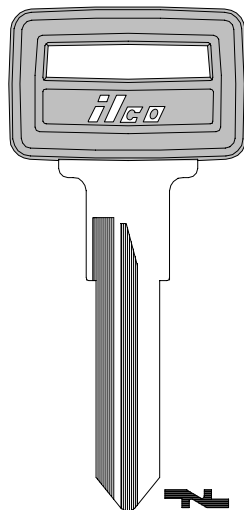

VL6-P
-

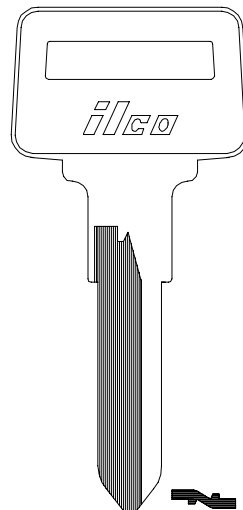

X140
VL8

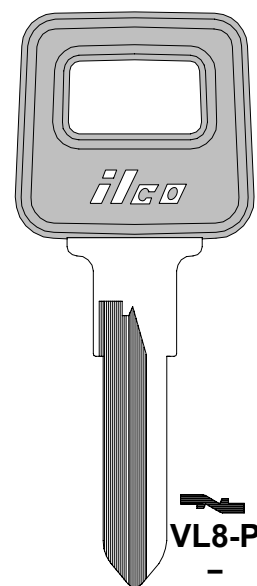

VL8-P
-

ILCO
EZ

VEHICLE KEYS

VOLVO

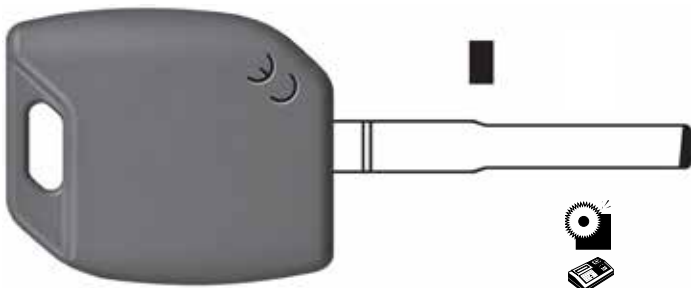

ILCO
EZ



HU101MH

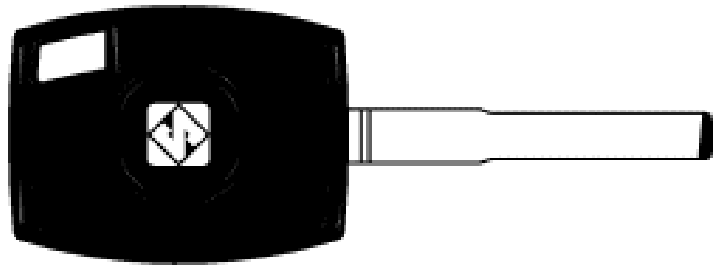

HU101-GTS

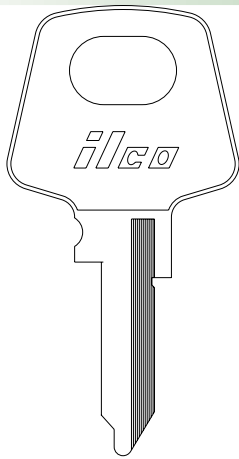

ILCO
EZ

X163
BL11



HU137MHK

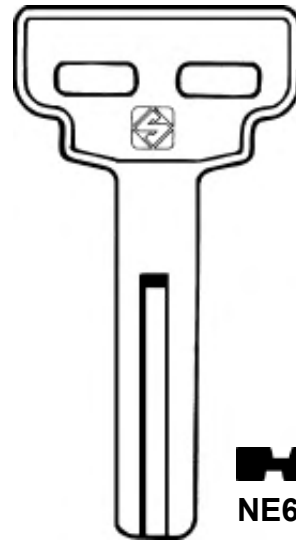
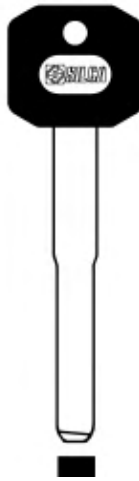

NE66-GTS

WARTBURG

WOLSLEY

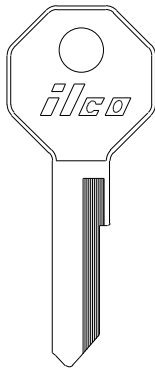

ILCO
EZ



WAR3



WAR4

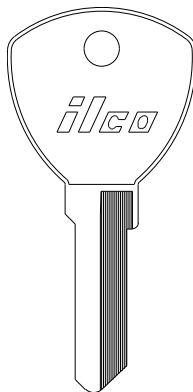

WAR1 WAR2



WA3

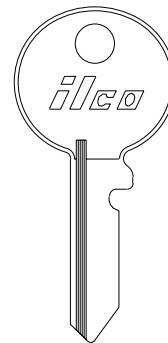

62DB

62DP





WOLSLEY

YAMAHA

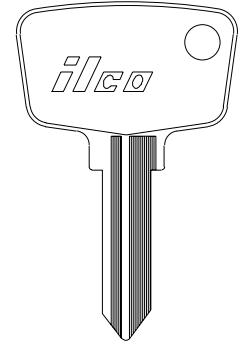
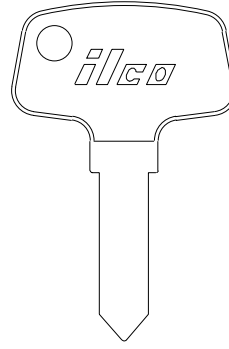
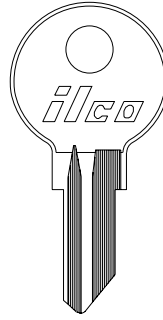
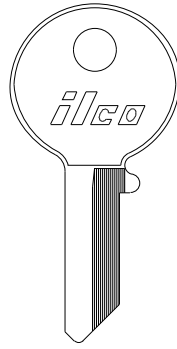
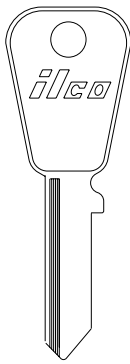
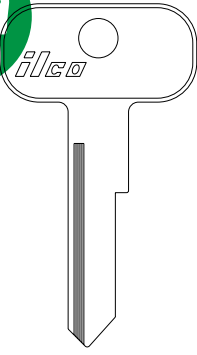

H62DP
-

S62DP
-

YH1
-

YH2
-

YH3
-

YH4
-

YH5
-

ILCO
EZ

YAMAHA

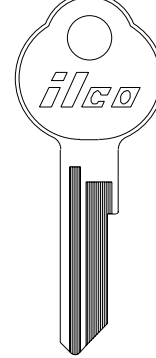
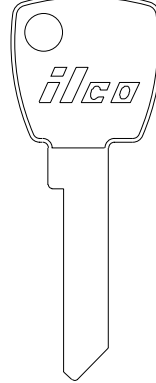
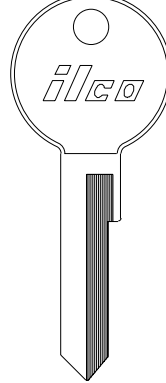
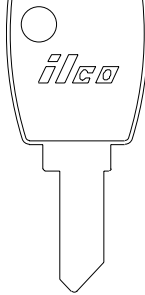
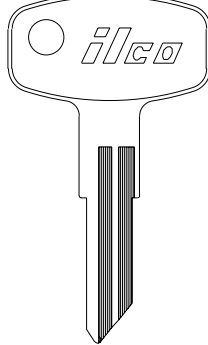
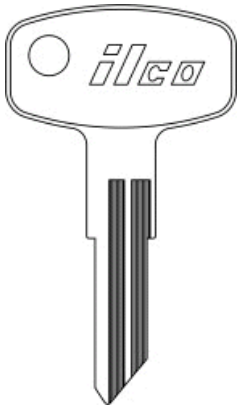

YH12
-

Y71H
-

YH6-SI
-

YH15
-

YH7
-

YH8
-

YH9
-

YH16
-

YH10
-

ILCO
EZ

YAMAHA

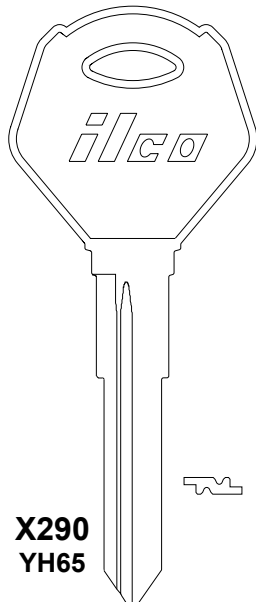

X290
YH65

ILCO
EZ

VEHICLE KEYS

SEC 1
PG 208



YAMAHA

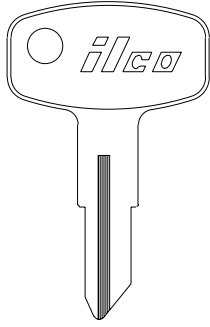
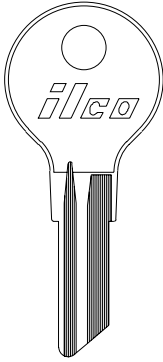

YH14

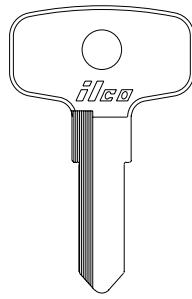

YH17

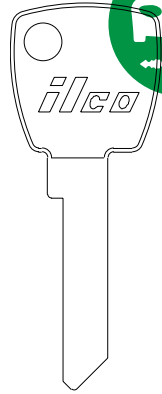
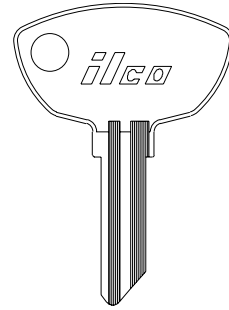

YH11
-



YH13
-



X18
YH21



X39
YH19



YH18
-



YH20
-

ILCO
EZ

YAMAHA

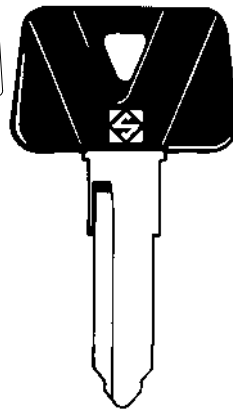
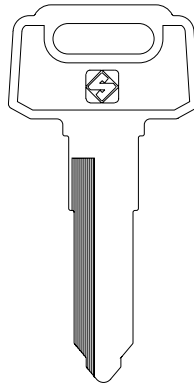
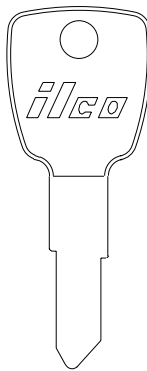
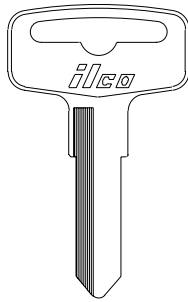
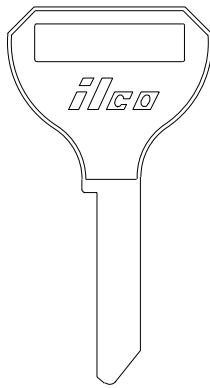

YH22 YH23
- -



YH24 YH29
- -



YH31
-



YH31R
-



YH31RAP
-



YH31RBP
-

ILCO
EZ

YAMAHA

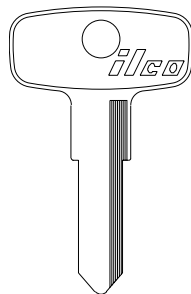
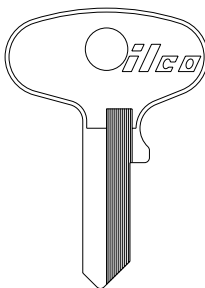
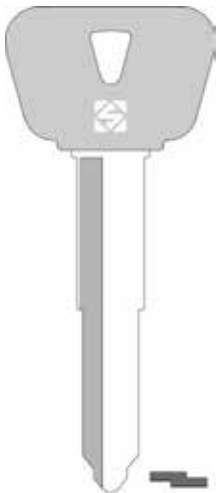

YH40



-

YH43



-

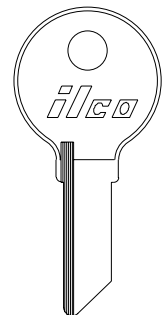
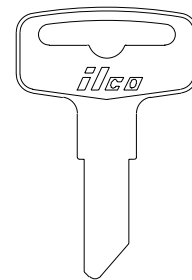

YH35RBP
-



X33
-



X48
-



YH39
-



YH41
-



YH42
-



X49
-

ILCO
EZ

VEHICLE KEYS



YAMAHA

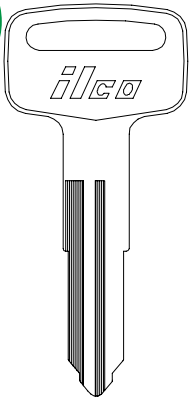

YH50 YH51

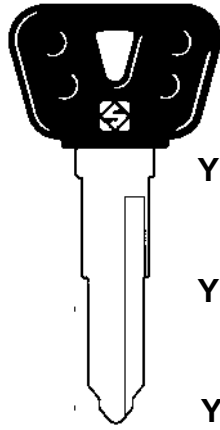

YH28BP YH28RBP
YH29BP YH29RBP
YH30BP YH30RBP

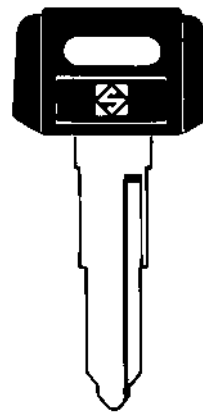

YH28P YH28RP
YH29P YH29RP
YH30P YH30RP

ILCO
EZ

VEHICLE KEYS

YAMAHA

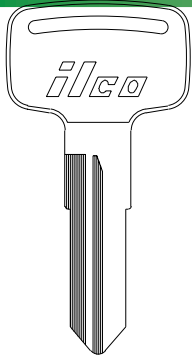

X69
YH37

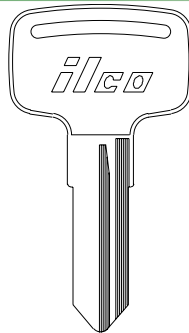

X72
YH36

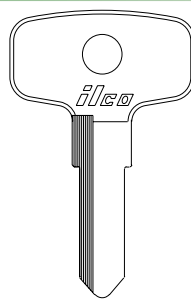

X75
YH33

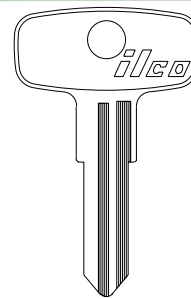

X74
YH34

X62 YH44 X107 YH45

X63 YH32 X76 YH30 X65 YH25 X66 YH26

X67 YH28 X68 YH27

ILCO
EZ

YAMAHA



YH35RMH

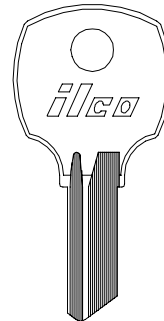

M1069L

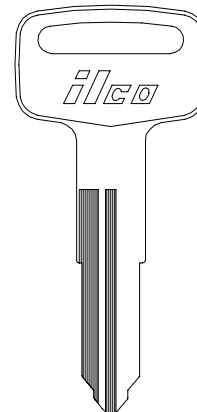

X117
YH48

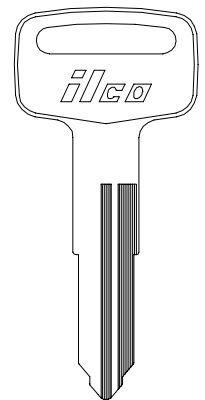

X118 YH49 ILCO
EZ



YAMAHA

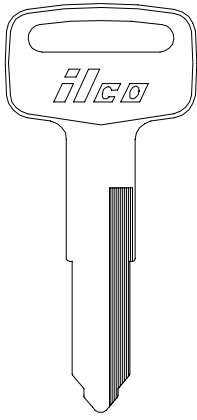

ILCO
EZ X119
YH47

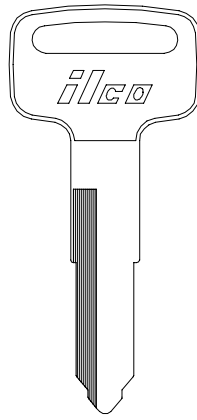

ILCO
EZ X120
YH46

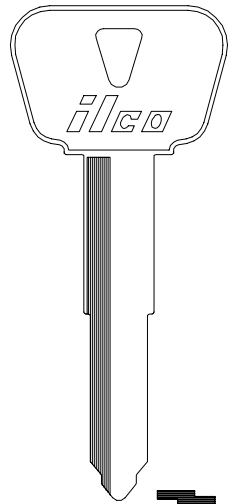

ILCO
EZ X248
YM63

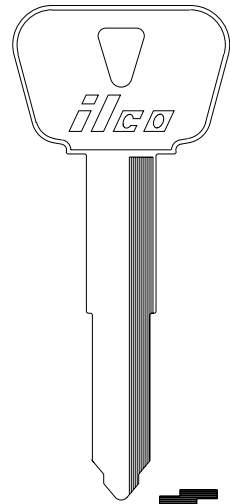

ILCO
EZ X277
YM64

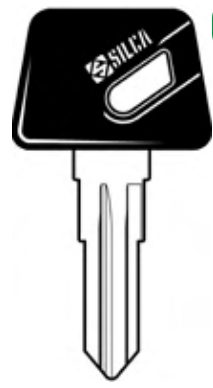

ILCO
EZ YH34P-SI
-



VEHICLE KEYS

SEC 1
PG 211

YAMAHA

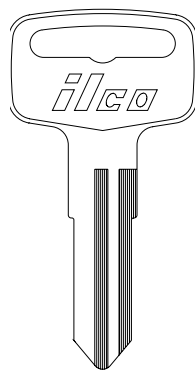

ILCO
EZ YH35
-



ILCO
EZ YH35RPB-SI
-

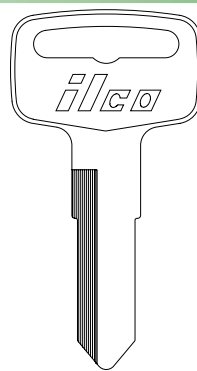

ILCO
EZ X77
YH38



ILCO
EZ X111
YM55



ILCO
EZ X112
YM56

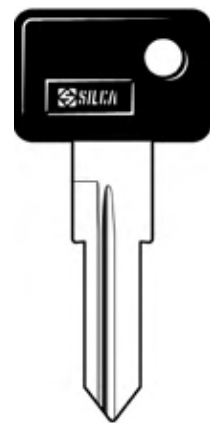

ILCO
EZ ZD16RP-SI
-

YAMAHA

YAMAHA OUTBOARD



ILCO
EZ ZD24RAT22-SI
-



ILCO
EZ ZD24RDP-SI
-



ILCO
EZ ZD24RT5-SI
-



ILCO
EZ YH52
-

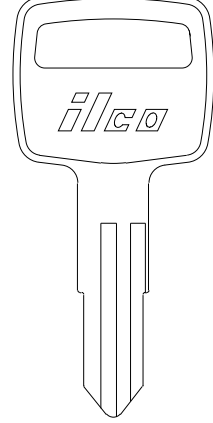

ILCO
EZ YH52R
-





YARD TRACTOR

YALE

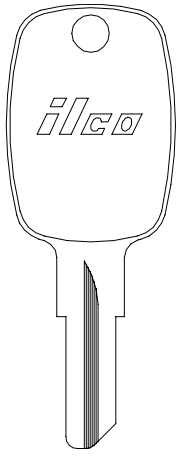

1098JD
-

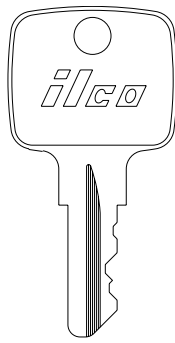

C1098JD
-

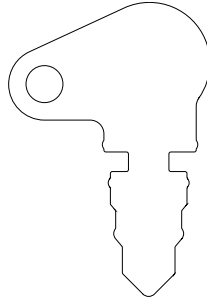

1147
-

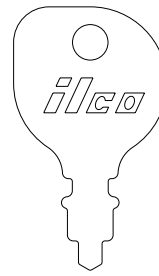

1148
-

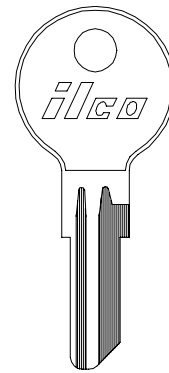

O1122A
Y12

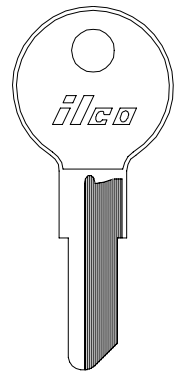

O1122ARILCC
Y14 EZ

YUGO

ZEPHYR



FT37 FT38
-

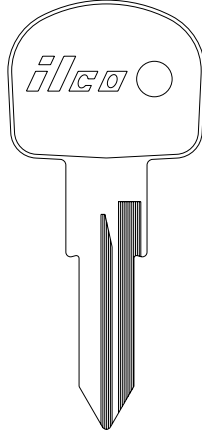

X152
FT46

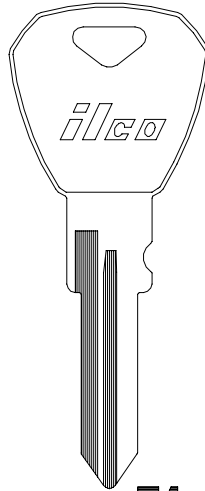

X153
YU1

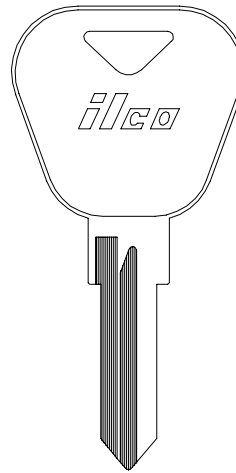

X167
YU2

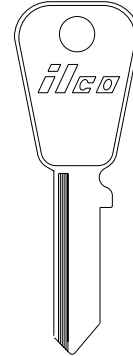

S62DP
-

ILCC
EZ

ZUNDAPP

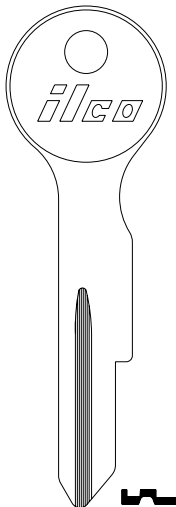

Z1
-

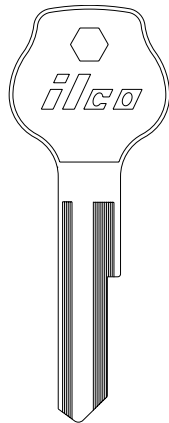

LR62VA
-

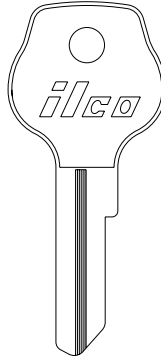

R62VA
-

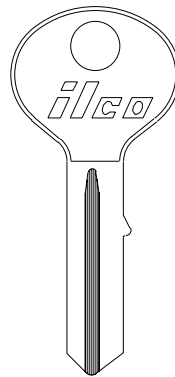

63J
-

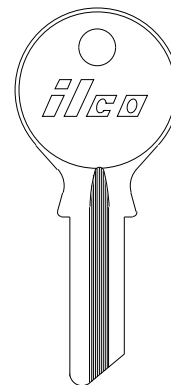

63L
-

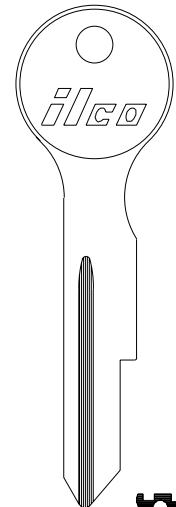

65J
ILCC
EZ

VEHICLE KEYS



SECTION 2 NORTH AMERICAN CYLINDER

Key Blanks designed for locks used primarily in the North American Market. The lock manufacturers are listed in alphabetical order where possible.

There are several symbols and suffixes used in this section. Below is a legend of their use.



Special Key Machine Required

-PC

Color Plastic Head Key

ACE

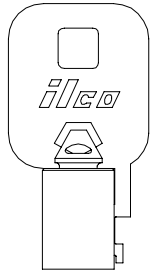

OD .377" - 0.6mm
ID .312" - 7.9MM
(BRASS)

ILCO
EZ

1137B
-

ACORN



A54B
-

ADAMS RITE



999
Y1



Y1-PC
-

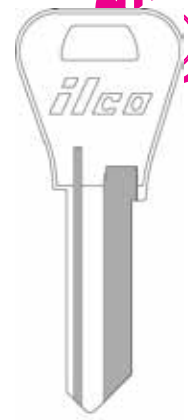

1054WB
WR3

ADAMS RITE



ILCO
EZ

D1054K
DE6



DE6-P
-



L1054B
IN8

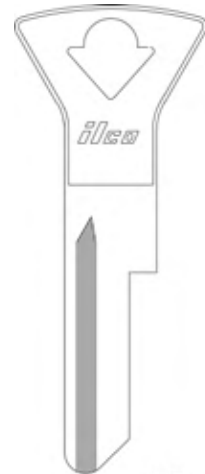

K1145
-

ALMET



1145A
SC4

ALMET



ILCO
EZ

1177N
NH1

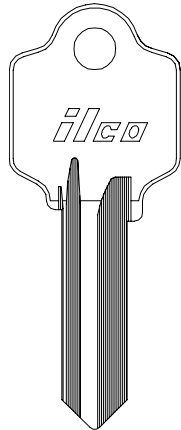

1179
AR1

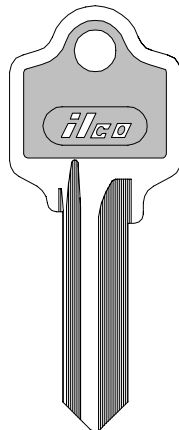

AR1-PC
-

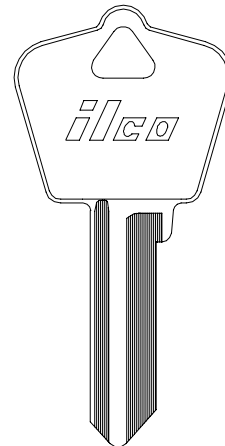

N1179
-

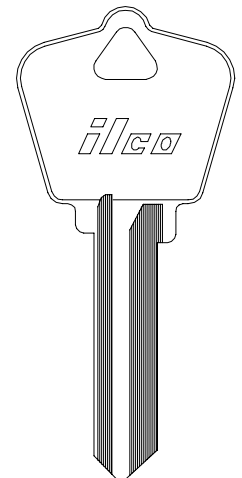

1179A
AR4



NORTH AMERICAN CYLINDER



AMERICAN LOCK

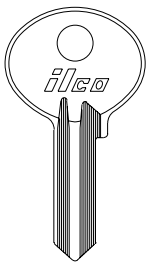

1041B
-

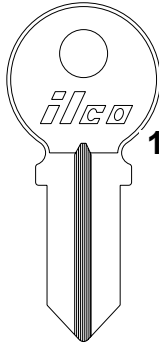

1041CK
-

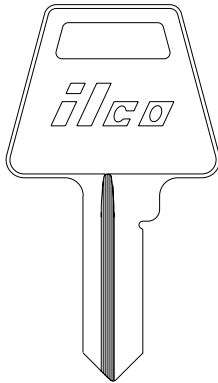

5 PIN
1045
AM3

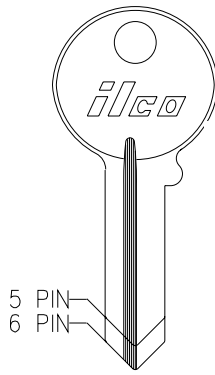

5 PIN
6 PIN

6 PIN
1046U

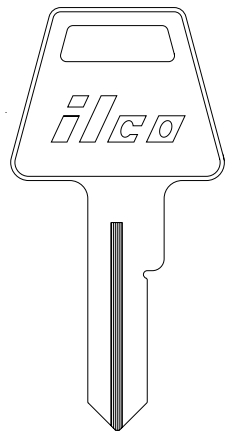

1045L
AM3L

ILCO
EZ

AMERICAN LOCK

AMEROCK

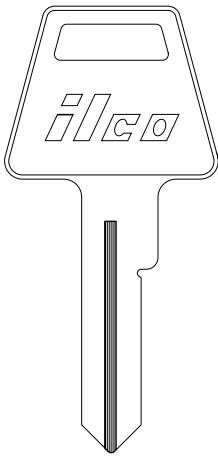

A1045L
-

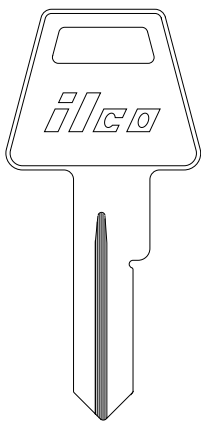

1653
AM4

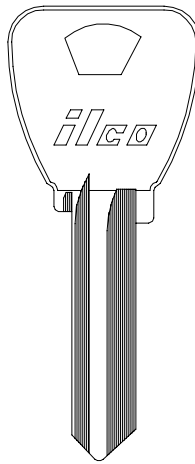

AK22W
-

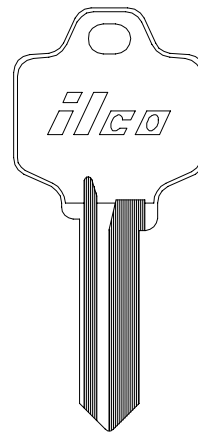

R1064E
NA25

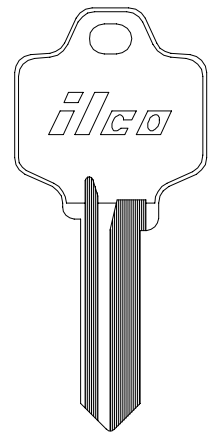

NA25-PC
-

ILCO
EZ

ARCO

ARFE

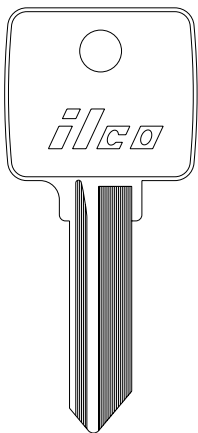

1130
-

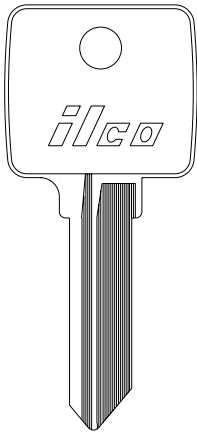

1130R
-

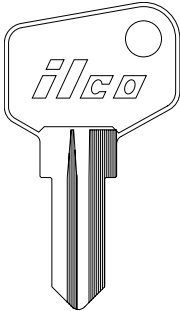

1635J
-

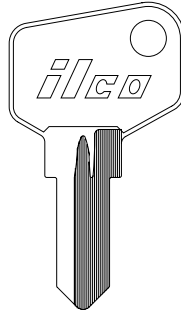

1635K
-

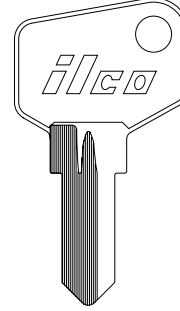

1635L
-

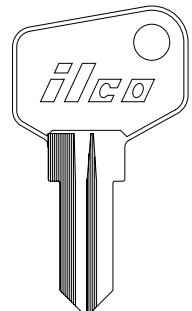

1635V
-

ILCO
EZ

NORTH AMERICAN CYLINDER



ARMSTRONG

ARROW

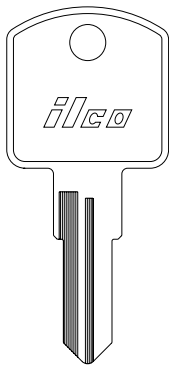

ILCO 1675
EZ -

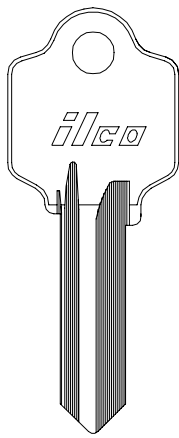

1179
AR1

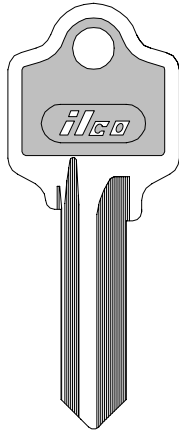

AR1-PC
-

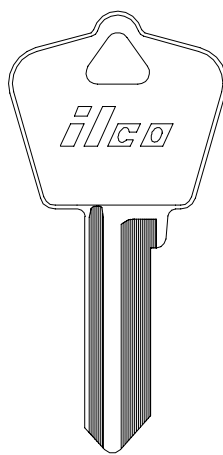

N1179
-

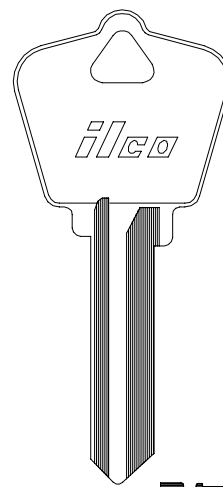

1179A
AR4

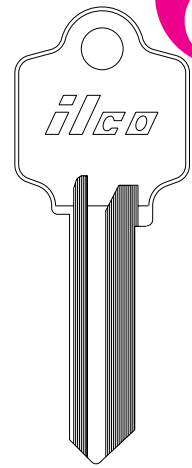

N1179A
-

ARROW

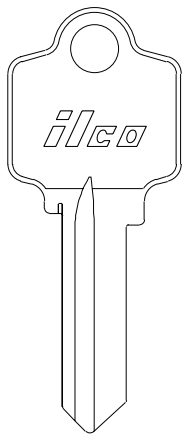

ILCO 1179SC
EZ AR1SC

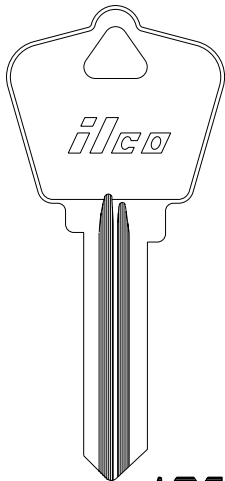

A1179E
-



A1179F
-



A1179K
-



A1179R
-



A1179V
-



A1179G
-



A1179L
-



A1179S
-



A1179H
-



A1179N
-



A1179T
-



A1179J
-



A1179P
-



A1179U
-

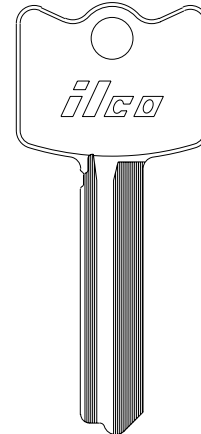

B1179-1C
-

ARROW

AUTH FLORENCE BALDWIN

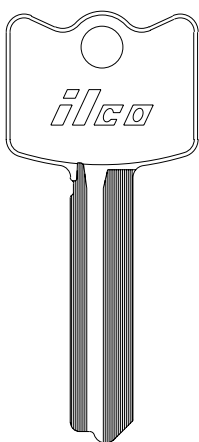

ILCO B1179-1D
EZ SC4

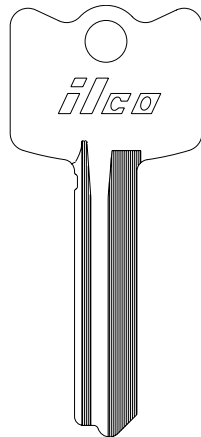

CH1C
-

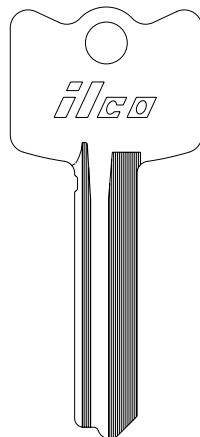

CH1D
-

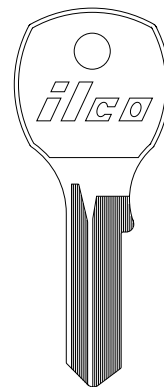

1652
AF1

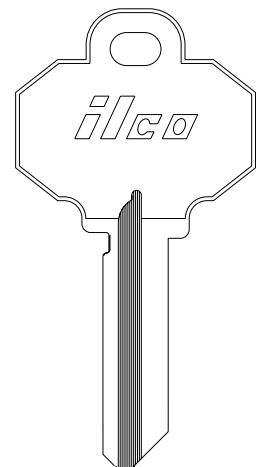

5 PIN
1510
BW2

6 PIN
1511
-

NORTH AMERICAN CYLINDER





NORTH AMERICAN CYLINDER

BARGMAN

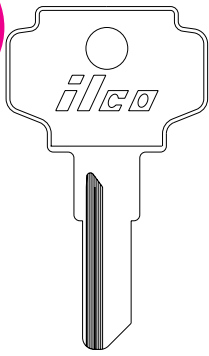

L1054M
-



K1054B
IN24

K1122B
-

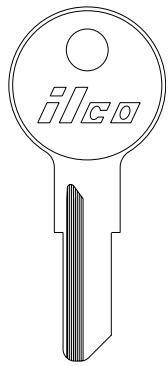

K1122C
-

K1122N
-

BARROWS

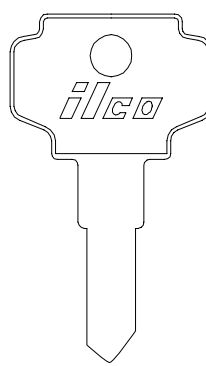

L1098M
-



K1122D
BN1

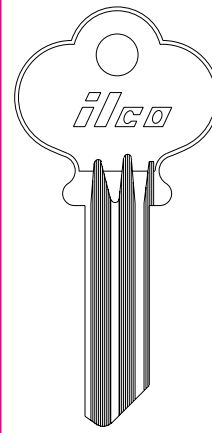

1021B
-

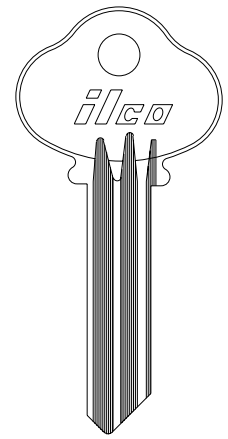

1021BA
-

ILCO
EZ

BARROWS

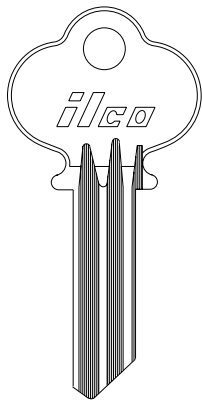

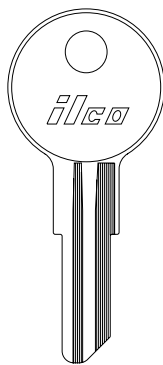

1021N
-

BAUER



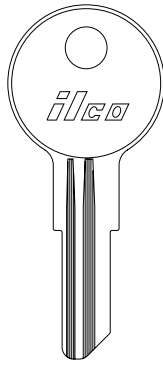

1618
BAU1

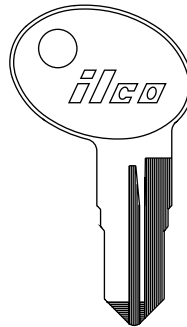

1618R
BAU1R



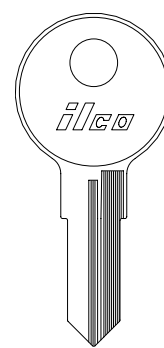

1648
BAU2

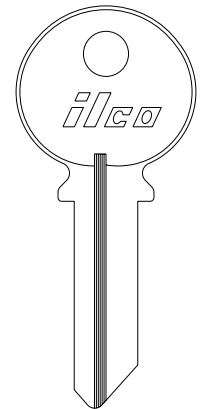

1676
BAU3

BELLEVILLE





1036
-

ILCO
EZ

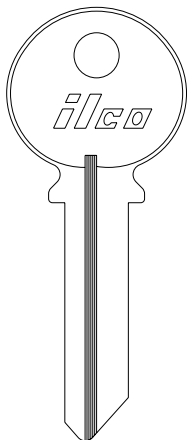
BELLEVILLE



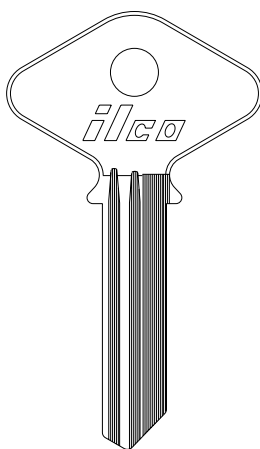

1036A
-



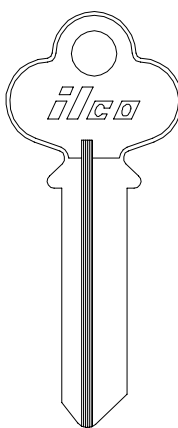

1036G
-

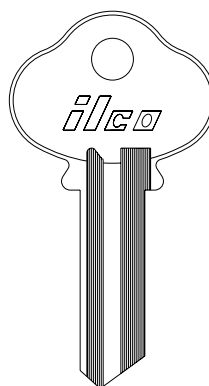



1036S
-

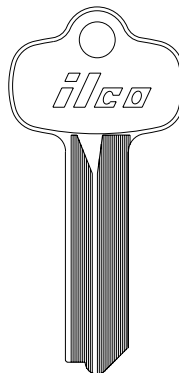



1036U
-

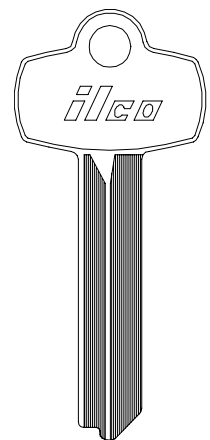



1114
-



A1114A
BE2 **ILCO**
EZ

BEST

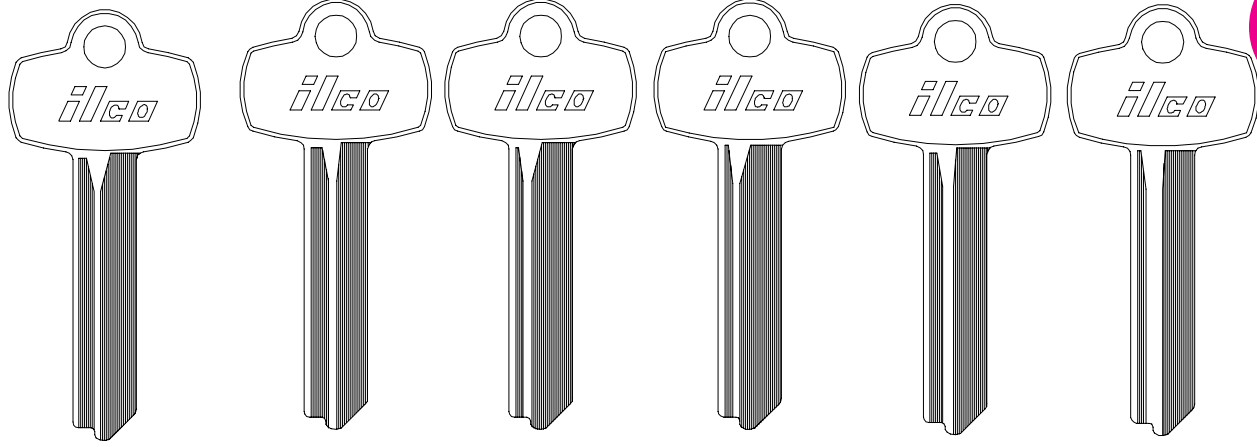
BEST



ILCO	A1114B	A1114C	A1114D	A1114DD	A1114E	A1114F
EZ	-	-	-	-	-	-

BEST

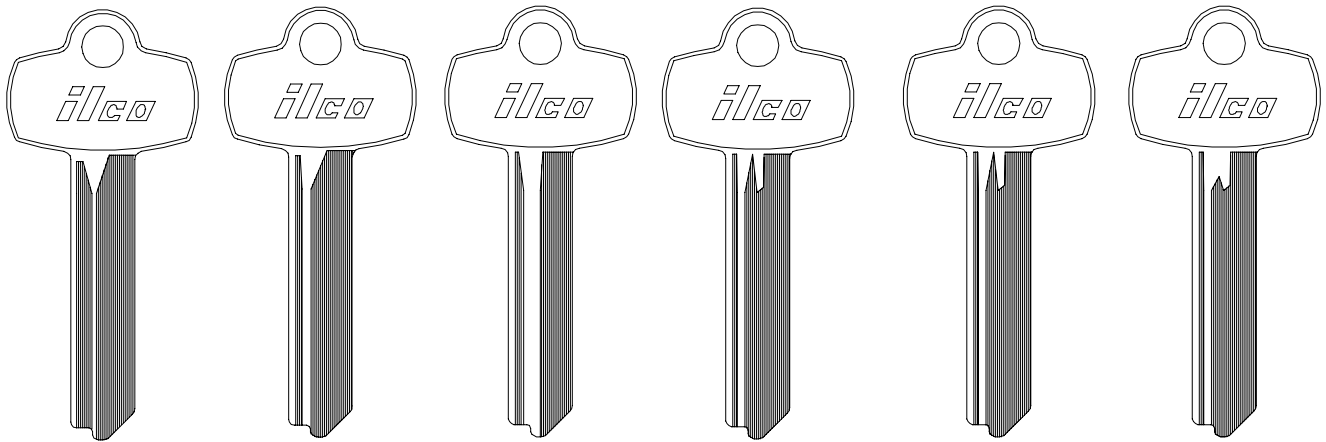

ILCO	A1114FM	A1114G	A1114H	A1114J	A1114K	A1114L
EZ	-	-	-	-	-	-

BEST



ILCO	A1114M	A1114Q	A1114R	A1114TB
EZ	-	-	-	-



NORTH AMERICAN CYLINDER



BOMMER

CAM LOCK

CANADIAN BLDR.

CANADA POST

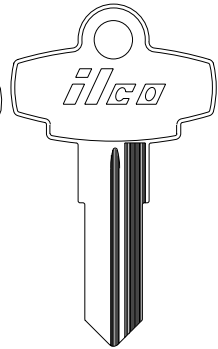
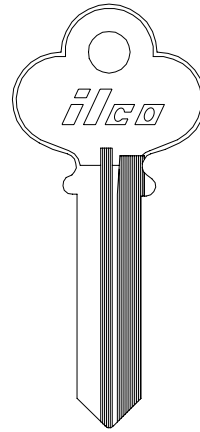
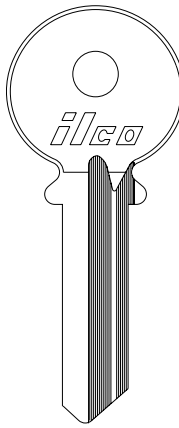
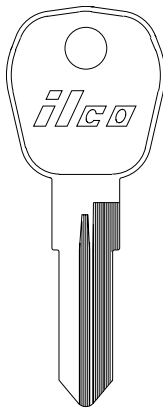
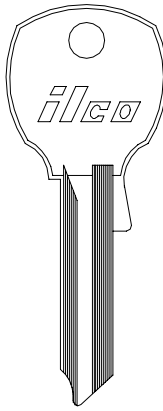
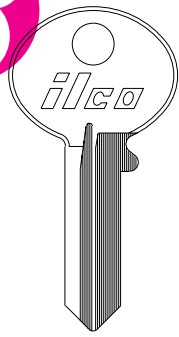

1003M
CO106

R1003M
BO1

1069LC
NA24

1631
-

25
-

P54F
-

752
-

ILCO
EZ

CANADA POST

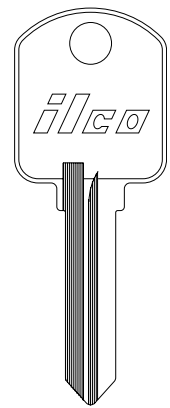
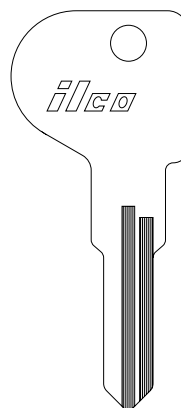
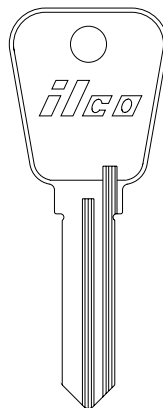
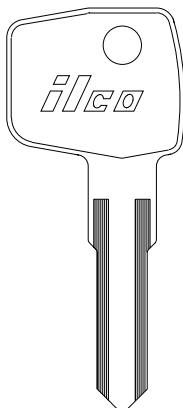
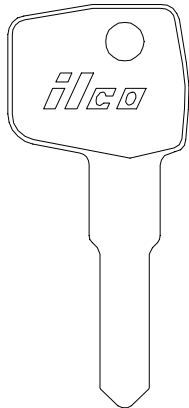
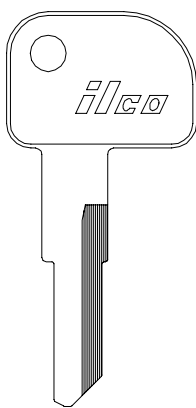

1558
-

1594
-

1632
-

LF25
-

1659
-

1659R
-

1661
-

ILCO
EZ

CANADA POST

CEMEX

CHALLENGER

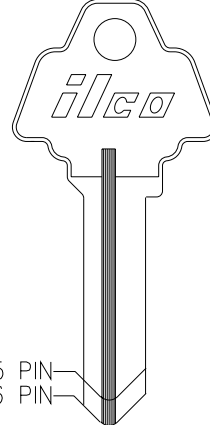
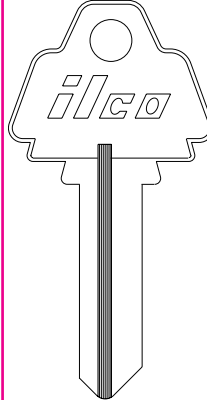
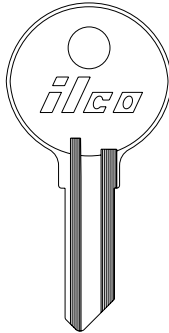
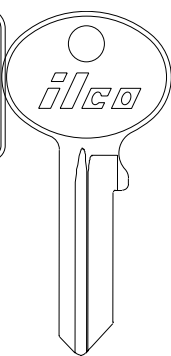
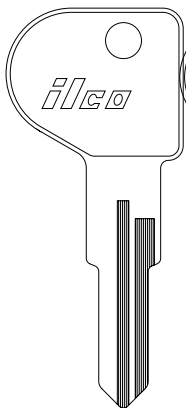

6 PIN



A1170C
-

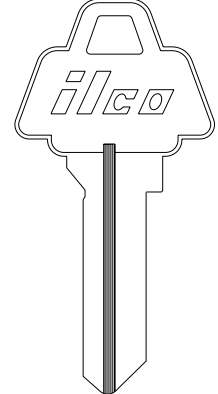

1669
-

1686
WN2

1550
-

1170
-

5 PIN
1170B
HO1

6 PIN
A1170B
HO4

1170C
-

ILCO
EZ

NORTH AMERICAN CYLINDER



CHANTRELL

CHICAGO



SEE
LOCKWOOD

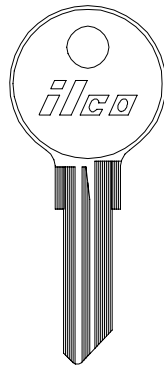

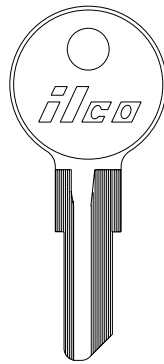

102AM
AP2

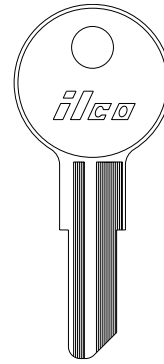

103AM
AP3



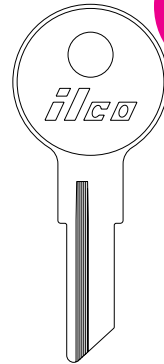

104AM
AP4





100AM
AP5

1041E
CG22



1041T
CG16

1041TR
-

1041X
-

ILCO
EZ

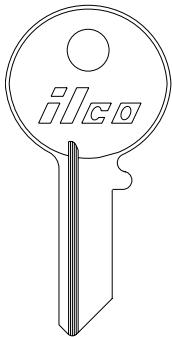
CHICAGO



ILCO
EZ
1041Y
CG17



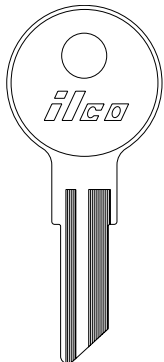

C1041A



C1041C





C1041B

C1041L

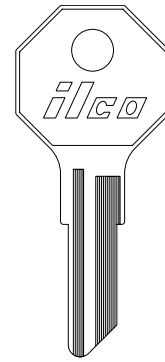

C1041N

C1041P

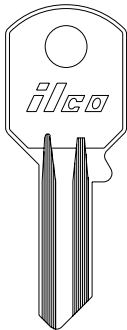

H1041T

CHICAGO







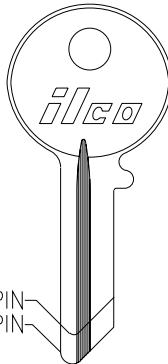

ILCO
EZ
S1041JA



S1041T



	4 PIN	5 PIN	4 PIN	5 PIN
	SC1041R	C1041R		SC1041TR
	-	-	-	-
	SC1041S	C1041JB		SC1041YR
	-	-	-	-
	SC1041SR	C1041SR		-
	-	-		-
	SC1041T	C1041T		-
	-	-		-





CHICAGO

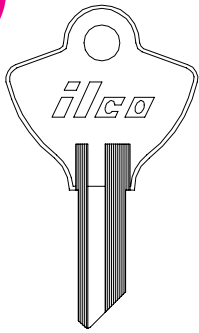

1096EN

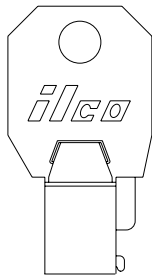

1136S



OD .365" - 9.3mm
ID .300" - 7.6mm
(STEEL)

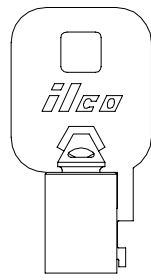

1137B



OD .377" - 0.6mm
ID .312" - 7.9mm
(BRASS)

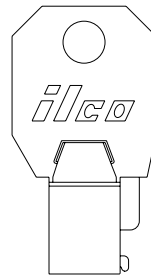

1137S



OD .377" - 0.6mm
ID .312" - 7.9mm
(STEEL)

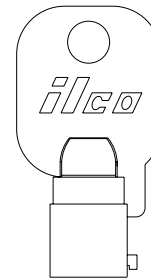

L1137



OD .399" - 10.1mm
ID .329" - 8.4mm
(STEEL)

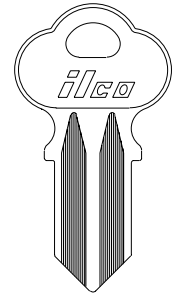

41FD



**ILCO
EZ**

CHICAGO

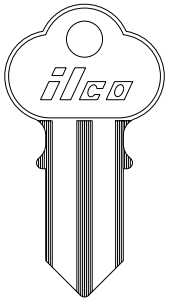

CC29



CC30

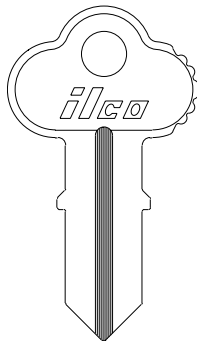

1041DC



1041DH



1041FE

1041FG

1041G

1041GA 1041N

1041GB

1041GR

1041K

**ILCO
EZ**

CHICAGO

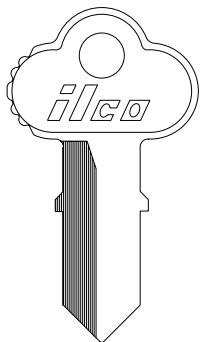

1041DE

R1041DC

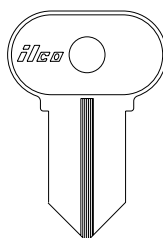

1041M

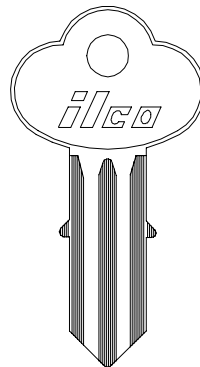

C1041DN

CLINTON

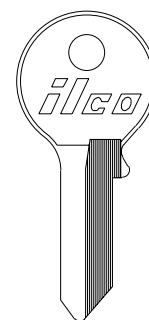

L67A

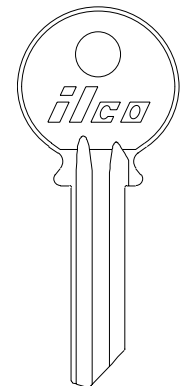

1067B

**ILCO
EZ**

NORTH AMERICAN CYLINDER



CLINTON

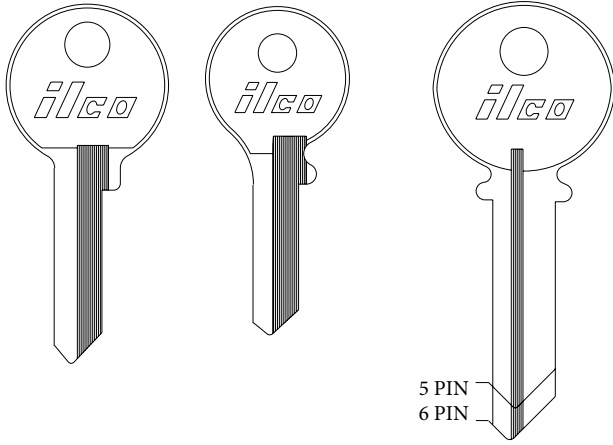

ILCO EZ T67C - T67D - 5 PIN 1023 - 6 PIN 1023A -

CLUB CAR

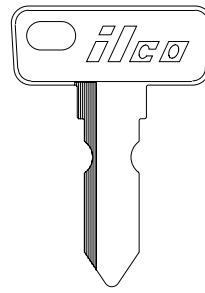

CC1 -

CCL (formerly Corbin Cabinet Lock)

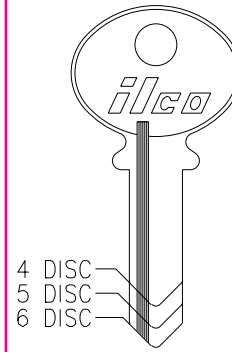

4 DISC 1000H -
5 DISC
6 DISC

5 DISC 1000G -
6 DISC 1000F CO17

CCL (formerly Corbin Cabinet Lock)

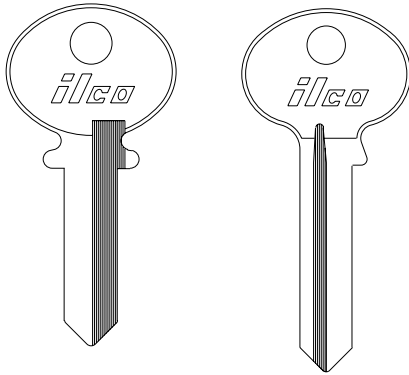

ILCO EZ 1000FR - X1000F -

X1000FR -

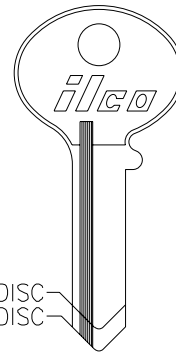

5 DISC X1000G - 6 DISC SX1000F -

5 DISC X1000GR - 6 DISC SX1000FR -
XO1000F -
XO1000GR -

CCL (formerly Corbin Cabinet Lock)



ILCO EZ O1000H - O1000GX - O1000GR - 1000KC - 1000K - X1000KC CO9 - 1000DA -

NORTH AMERICAN CYLINDER



CCL (formerly Corbin Cabinet Lock)

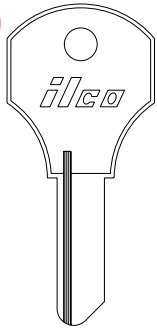

1000W
-



5 DISC
6 DISC

S1000T 1000T
-

5 DISC 6 DISC
SR1000T R1000T
-

S1000V 1000V
-

SR1000V R1000V
-

1000P
-

5 DISC 6 DISC
S1000X 1000X
-

1000XK
-



1001CR
-

**ILCO
EZ**

NORTH AMERICAN CYLINDER

CCL (formerly Corbin Cabinet Lock)

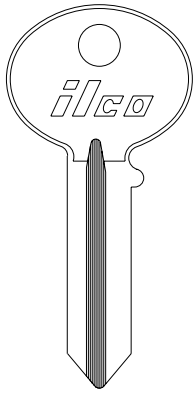

1001D R1001D
-

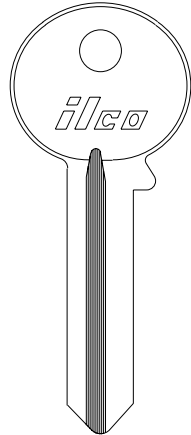

1001DA
-

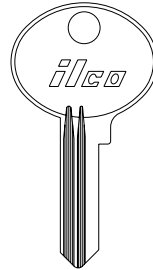

1001K
-

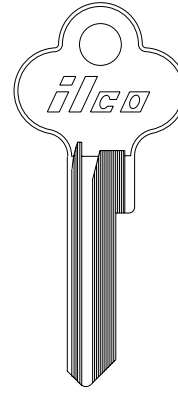

X1001KC
-

**ILCO
EZ**



4 PIN	S1003A -			
5 PIN	1003A -			
6 PIN	L1003A -			

4 PIN	S1003AB -	
5 PIN	1003AB -	1003CD -
6 PIN	L1003AB -	

4 PIN	S1003M -
5 PIN	1003M CO106
6 PIN	L1003M -

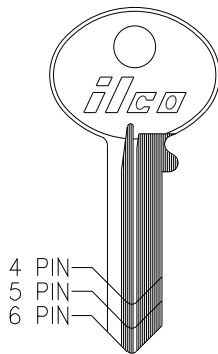

NORTH AMERICAN CYLINDER



CORBIN (now Corbin/Russwin)

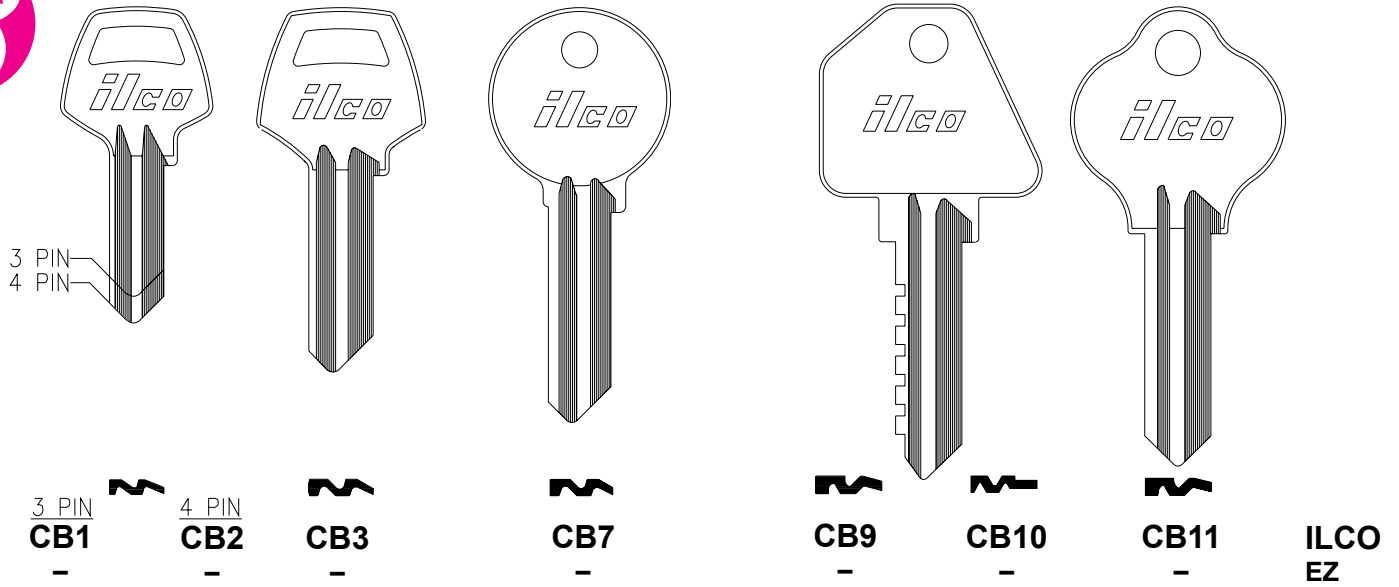

CORBIN (now Corbin/Russwin)

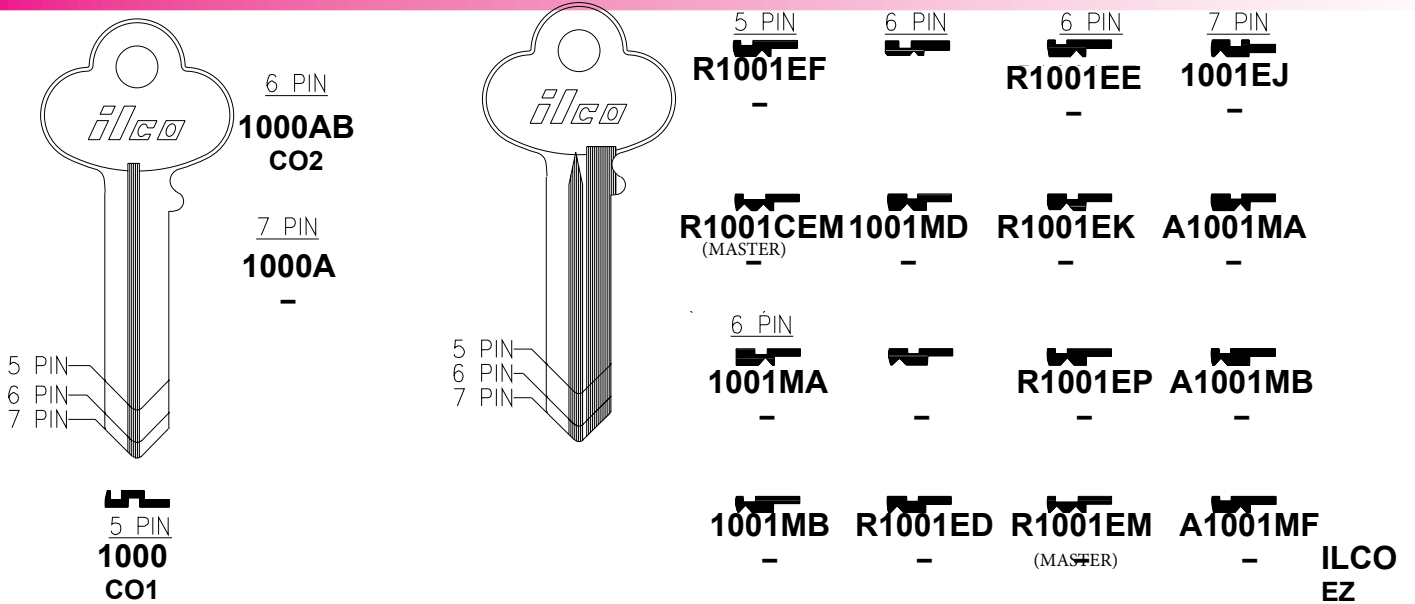

CORBIN (now Corbin/Russwin)

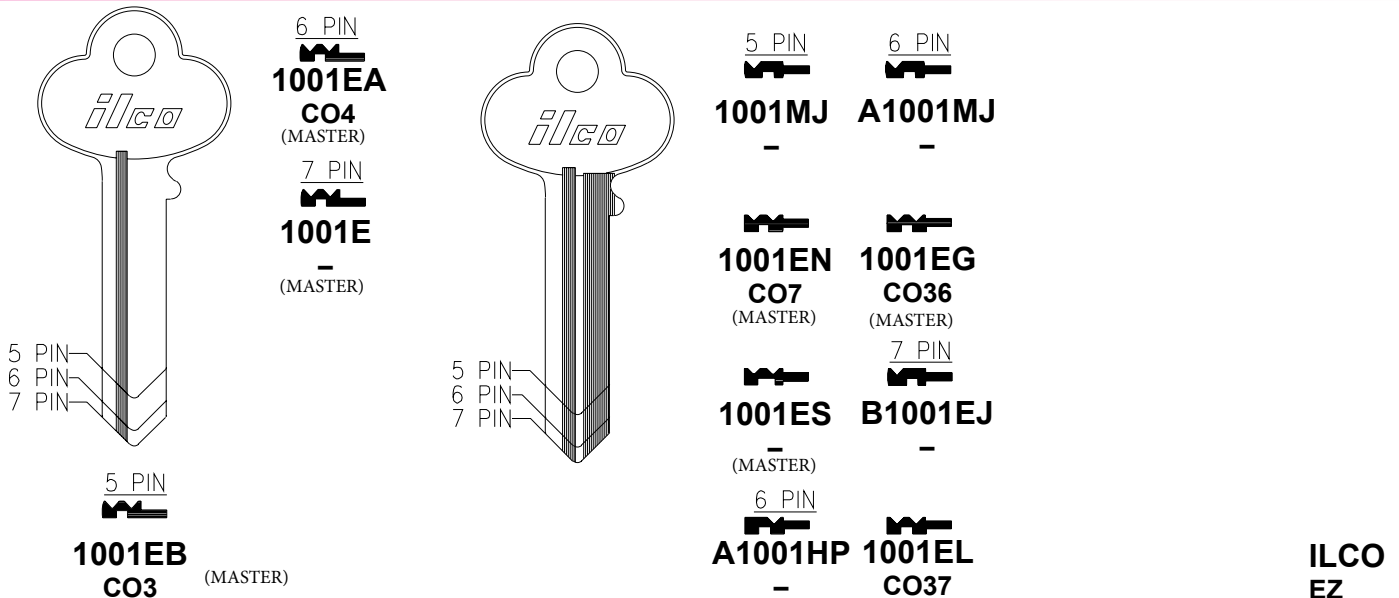



NORTH AMERICAN CYLINDER



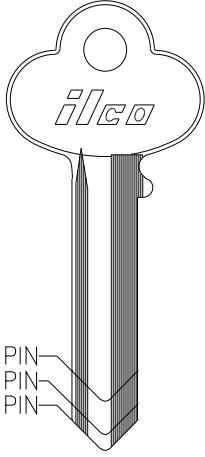



CORBIN (now Corbin/Russwin)



<u>5 PIN</u> 	<u>6 PIN</u> 
R1001MJ R1001EG	
-	CO62
(MASTER)	(MASTER)

	
R1001EN R1001ET	
SK1	-
(MASTER)	

	<u>7 PIN</u> 
	
R1001ES R1001EL	
-	-
(MASTER)	(MASTER)

<u>6 PIN</u> 
A1001MJR
-

ILCO
EZ

CORBIN (now Corbin/Russwin)

ILCO
EZ

CORBIN (now Corbin/Russwin)

ILCO
EZ















NORTH AMERICAN CYLINDER





NORTH AMERICAN CYLINDER

								
5 PIN	1001AH -	1001FH -			1001C1 -	1001C2 -	1001D1 -	1001D2 -
6 PIN	A1001AH -	A1001FH -	A1001BH -	A1001DH -	A1001C1 -	A1001C2 -	A1001D1 -	A1001D2 -
7 PIN	L1001AH -		L1001BH -					L1001D2 -

				
5 PIN	1001AM -	1001BM -	1001CM -	1001DM -
6 PIN	A1001AM -	A1001BM -	A1001CM -	A1001DM -

		
5 PIN	1001ABM -	1001CDM -
6 PIN	A1001ABM -	A1001CDM -

	
5 PIN	1001GRM -
6 PIN	A1001GRM -
7 PIN	L1001GRM -

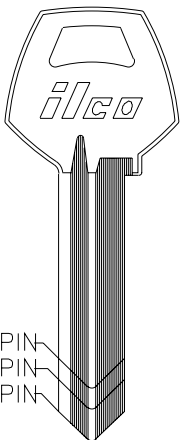

5 PIN
6 PIN
7 PIN

ILCO
EZ



CORBIN (now Corbin/Ruswin)

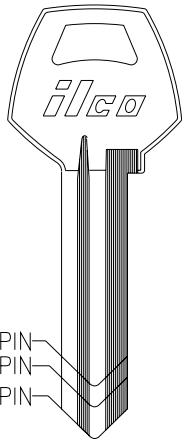

A1001EH
CO88

L1001EH
-

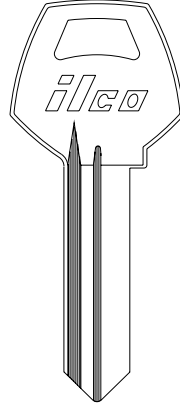

A1001EHR
-

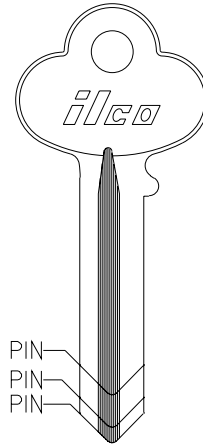

6 PIN
1001AB
-

7 PIN
1001A
-

ILCO
EZ
1001EH
CO87

1001
CO5

CORBIN (now Corbin/Ruswin)

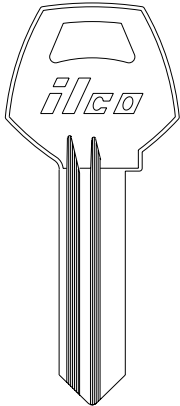

1001A1 **1001A2**
-

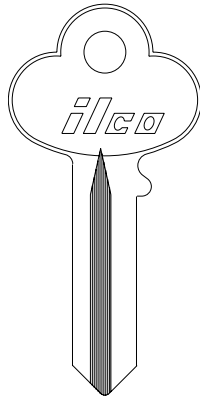

1001C
-

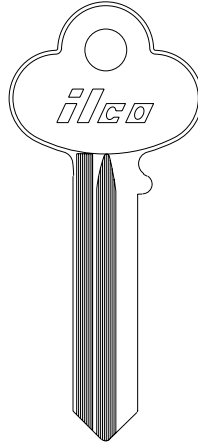

1001GA
-

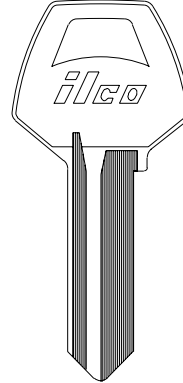

1001GH
-

NORTH AMERICAN CYLINDER



NORTH AMERICAN CYLINDER

5 PIN	1011-L1 -	1011-L2 -	1011-L3 -	1011-L4 -
6 PIN	A1011-L1 -	A1011-L2 -	A1011-L3 -	A1011-L4 RU101
7 PIN				L1011-L4 -

5 PIN	1011-L12 -	1011-L34 -
6 PIN	A1011-L12 -	A1011-L34 -

5 PIN	1011-L41 -
6 PIN	A1011-L41 -
7 PIN	L1011-L41 -

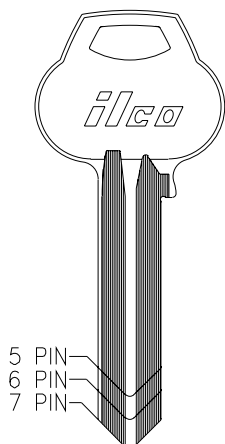

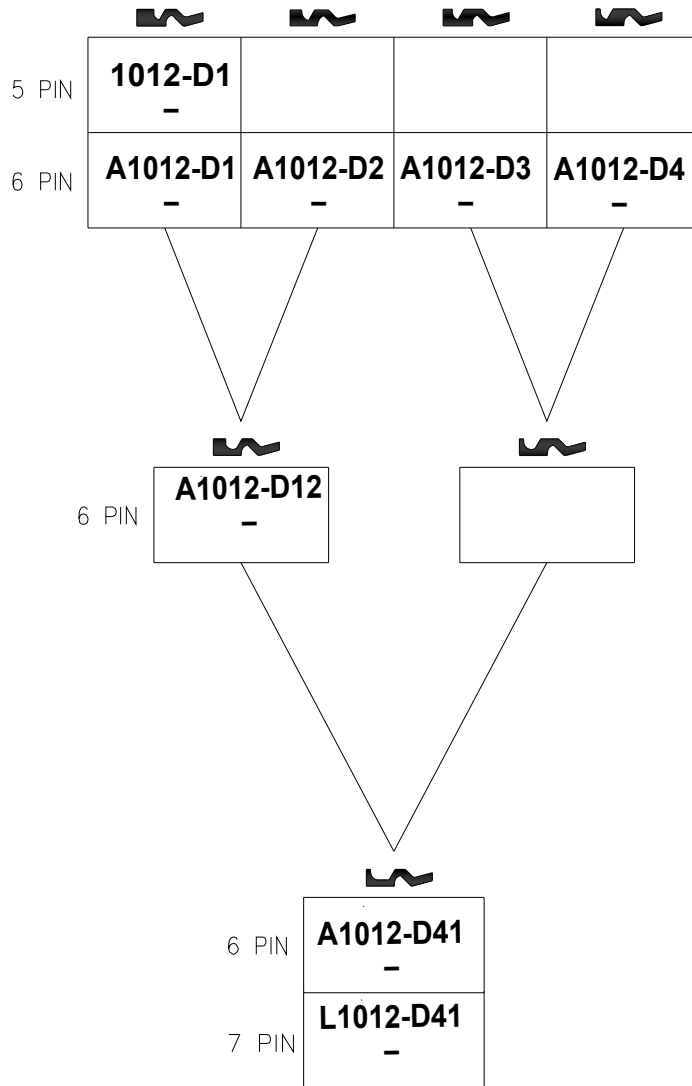

ILCO
EZ

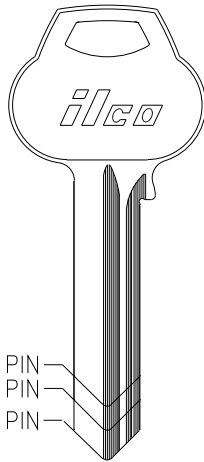

ILCO
EZ

NORTH AMERICAN CYLINDER

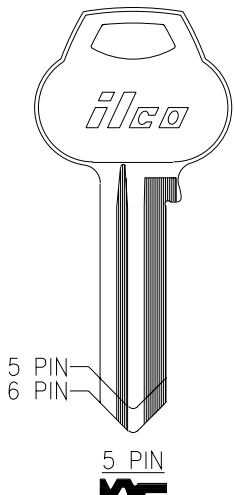

ILCO
EZ



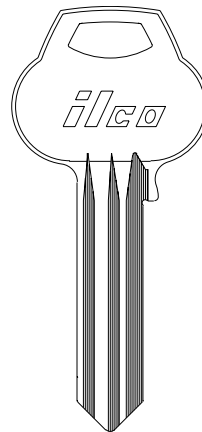





1012-60 -



	A1012-H1 -		A1012-H6 -
	A1012-H2 -		A1012-H7 -
	A1012-H3 -		A1012-H8 -
	A1012-H5 -		





							
A1012-59A1	A1012-59A2 -	A1012-59B1 -	A1012-59B2 -	A1012-59C1 -	A1012-59C2 -	A1012-59D1 -	A1012-59D2 -

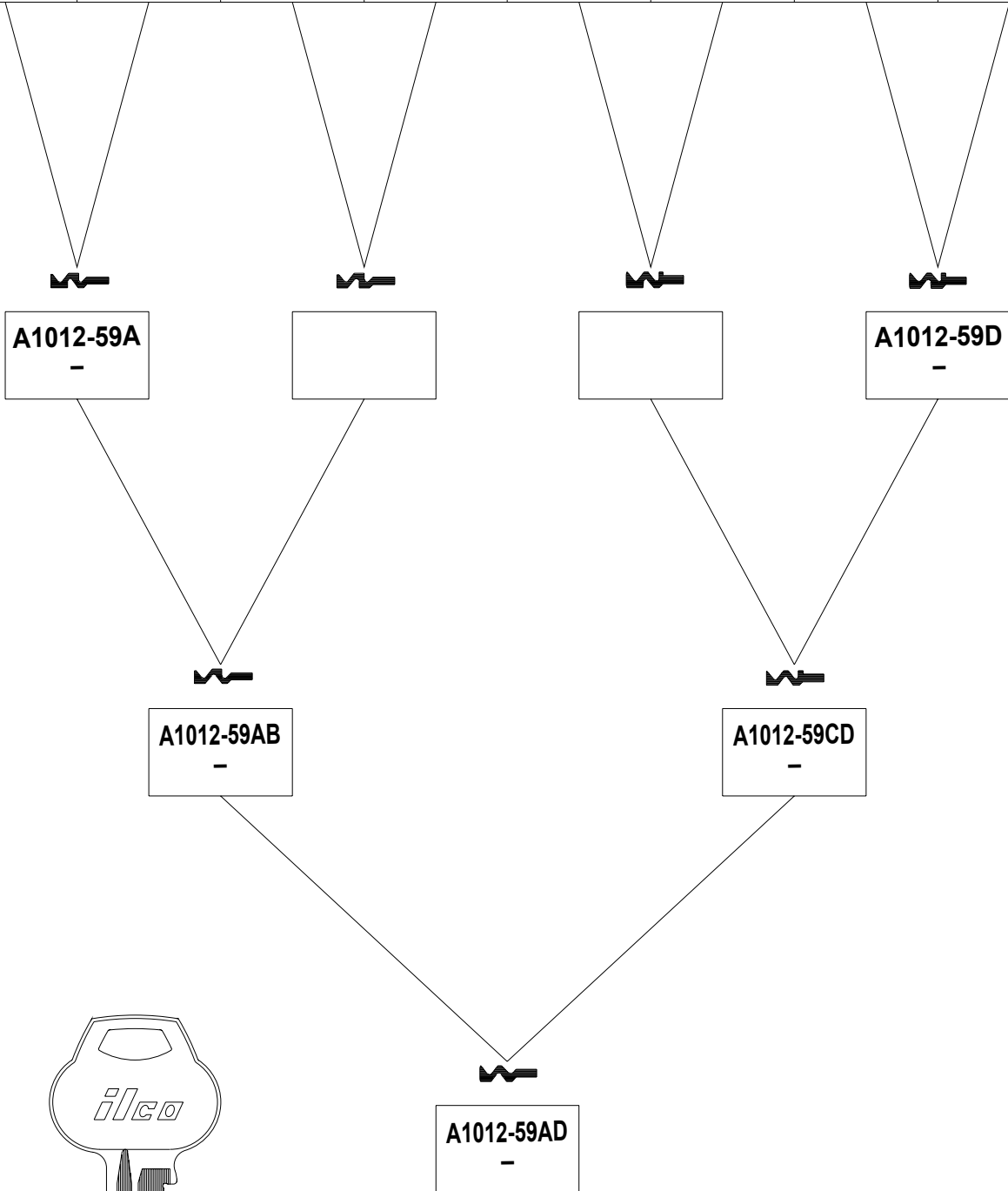



SEE
ELGIN

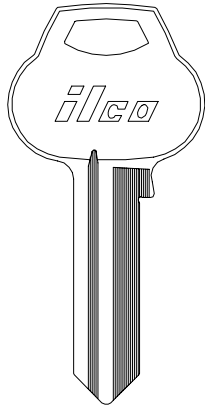

ILCO
EZ
CR87
-

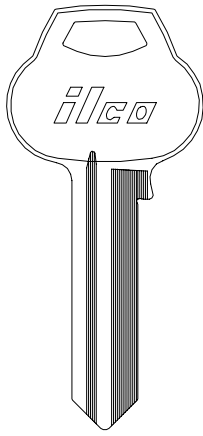

CR88
-

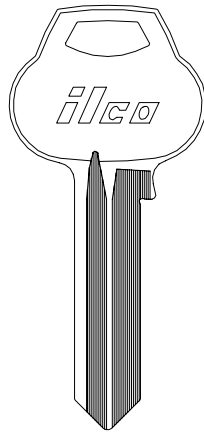

CR89
-

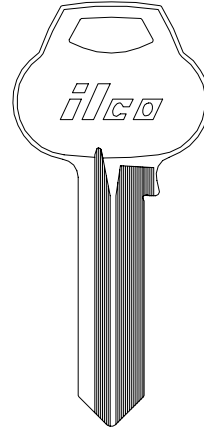

CR91
-

CUTLER

DEXTER / MASTER

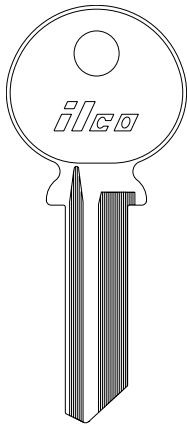

ILCO
EZ
1181C
-

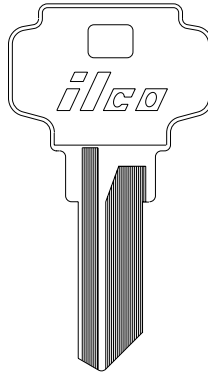

1054KD
DE1

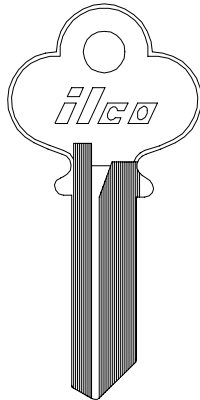

A1054KD
DE5

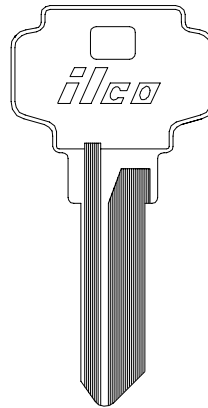

D1054K
DE6

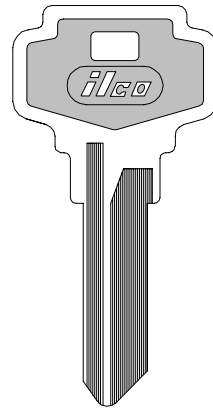

DE6-PC
-

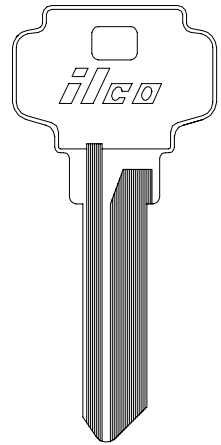

D1054KA
DE8

DEXTER / MASTER

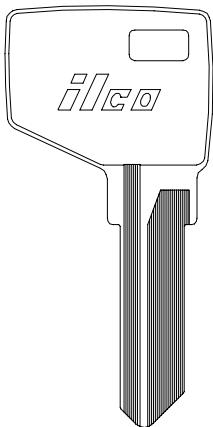

ILCO
EZ
MD1054K
MD17

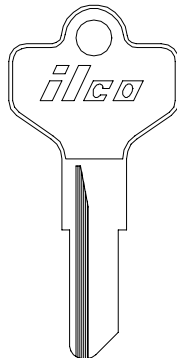

D1098B
DE2

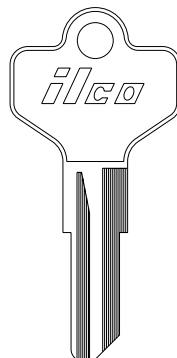

D1098BM
-

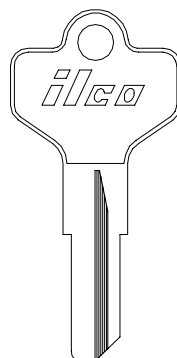

D1098X
DE4

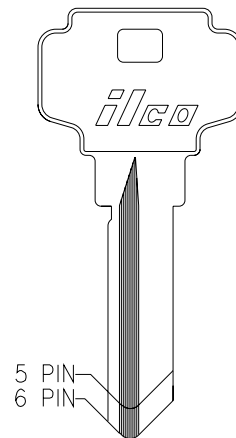

D1145 **D1145A**
- -

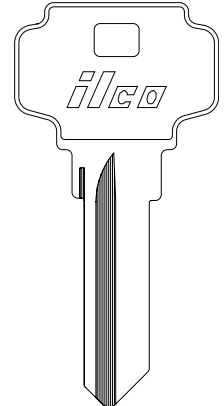

DS1145
DE9

NORTH AMERICAN CYLINDER



*Corbin-Russwin is a trademark of a third party not affiliated or linked with Kaba Ilco or the Dormakaba Group.



DEXTER / MASTER

DOM

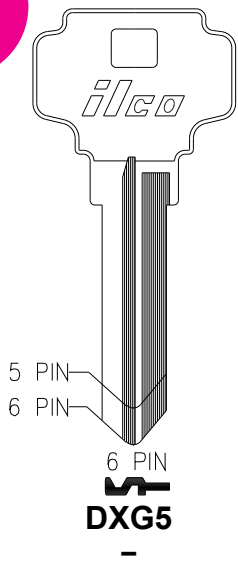

5 PIN

DX18R
 -

DXD30
 -

6 PIN

DXD4
 -

DXD3
 -

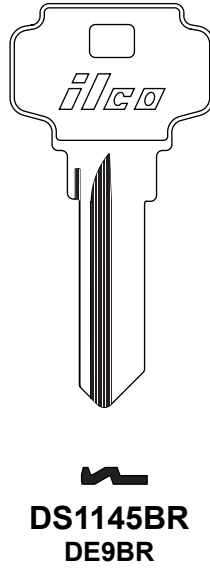

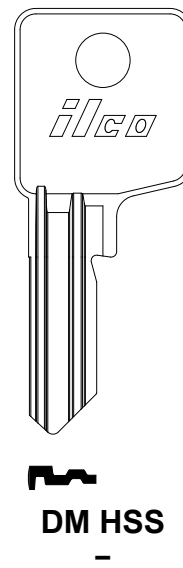

DS1145BR
DE9BR







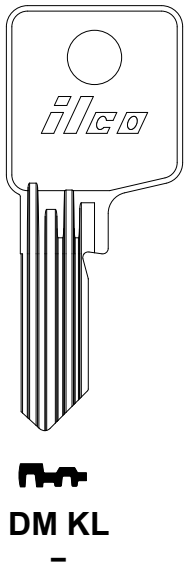



DM HSS
 -

ILCO
EZ

DOM







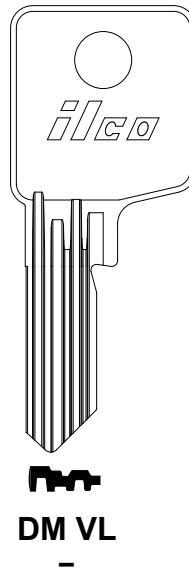

DM KL
 -

 
DM KM DM KQ
 - -
 
DM KN DM KR
 - -
 
DM KO DM KS
 
DM KP DM KT
 - -

DM KU
 -





DM VL
 -

 
DM VM DM VP
 - -
 
DM VN DM VQ
 - -
 
DM VO DM VR

ILCO
EZ

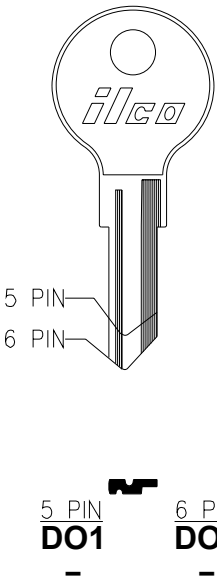
DOMINION LOCK



 5 PIN **DO1**
 -

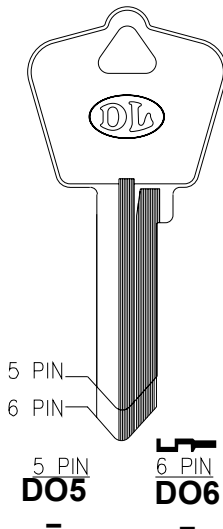

 6 PIN **DO2**
 -

5 PIN  6 PIN
DO3 **DO4**
 - -



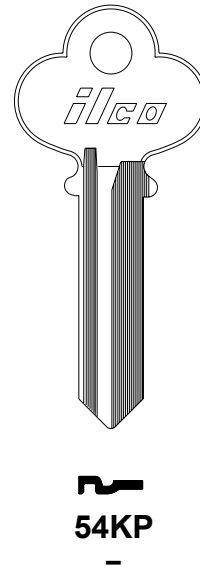

 5 PIN **DO5**
 -

 6 PIN **DO6**
 -

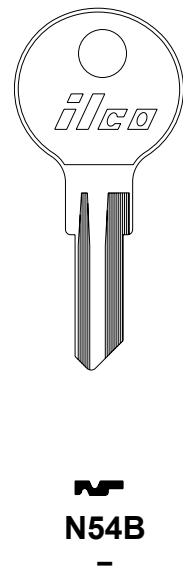

54KP
 -









N54B
 -

ILCO
EZ



DOMINION LOCK



						
ILCO	P54F	S54F	S54F-PC	N54G	L54K	752
EZ	-	-	-	-	-	-

DOMINION LOCK

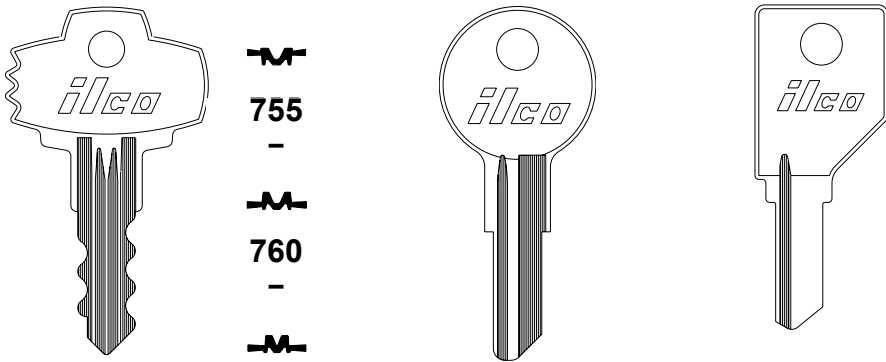

				
	755	760	L1054B	1866-DO3
	-	-	-	-
ILCO	750	757		
EZ	-	-		



NORTH AMERICAN CYLINDER





DONNER

DYNALOCK

EAGLE LOCK

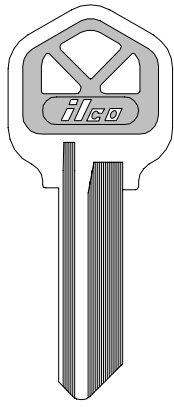
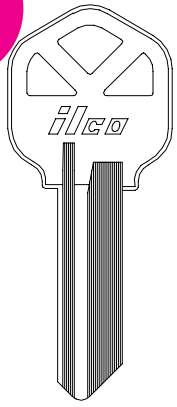

**SEE
ILCO**

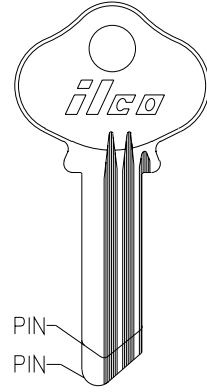
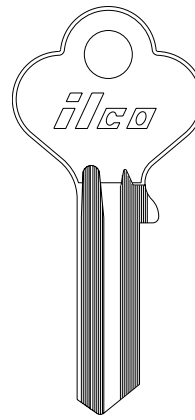
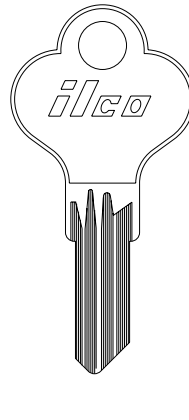

**1176
KW1**

**KW1-PC
-**

**1013DL
-**

**1013F
-**

**1014 1014A
- EA1**

**ILCO
EZ**

EAGLE LOCK

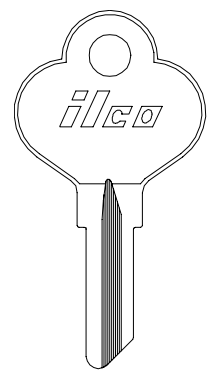
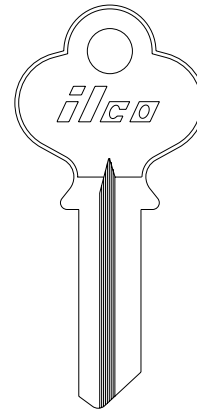
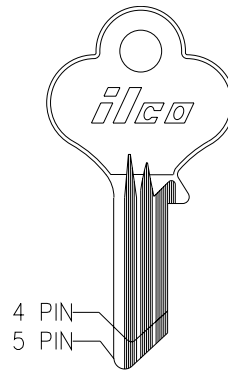
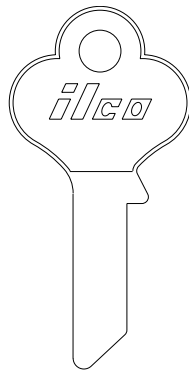
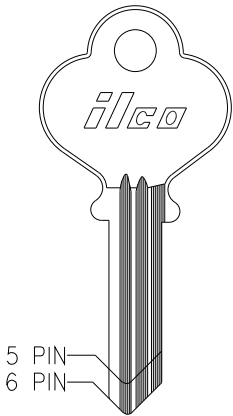

**1014D 1014DA
-**

**1014K
-**

**1014DS 1014DX
- EA13**

**1014F
-**

**1014J ILCO
EA32 EZ**

EAGLE LOCK

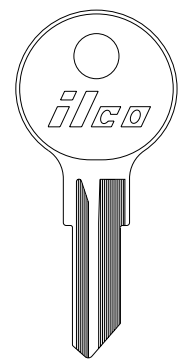
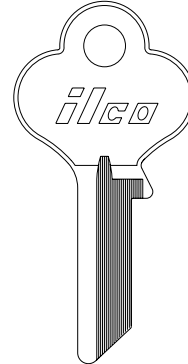
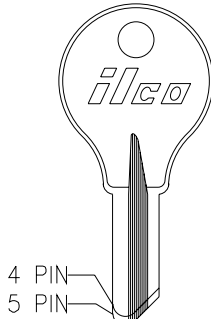
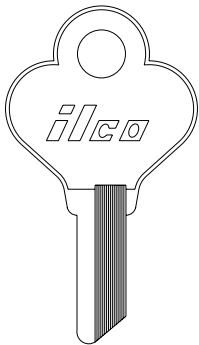

**1014JM 1014JSX
-**

**1014JS 1014J
-**

**1014JM 1014SM
-**

**1014K
-**

**1014P 1014S ILCO
- EZ**

NORTH AMERICAN CYLINDER



EAGLE LOCK

EAGLE PADLOCK

EARLE

EBERHARD

ELGIN

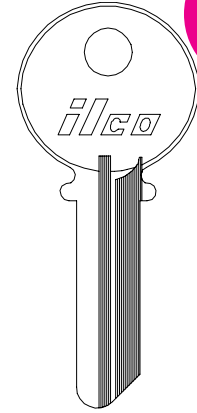
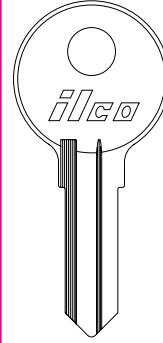
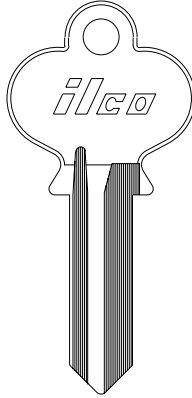
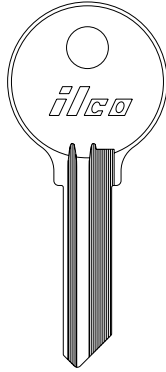
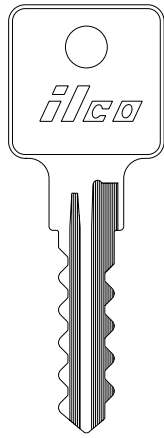
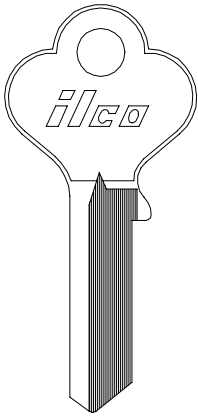

ILCO
EZ
X1014F
EA27

1521
-

1533
-

1119
ER1

1678
-

1096
EL2

ELGIN

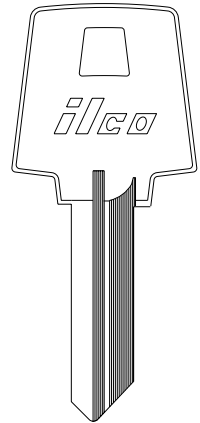
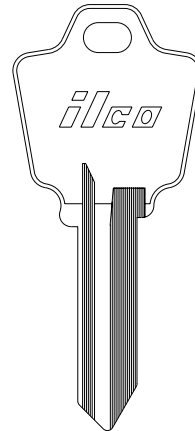
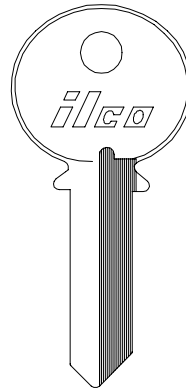
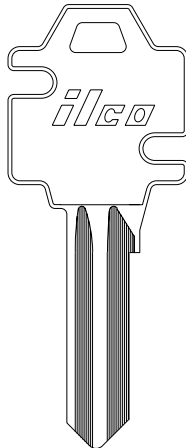
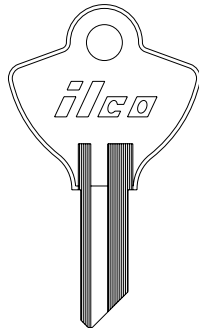
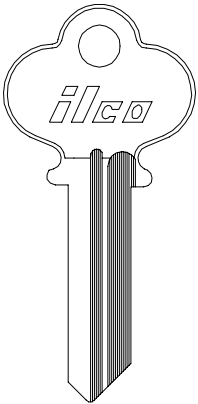

ILCO
EZ
1096C
EL1

1096EN
-
R1096EN
EL21

1096FL
-

1096L
EL3

1096NL
-

C1096C
-

ELGIN

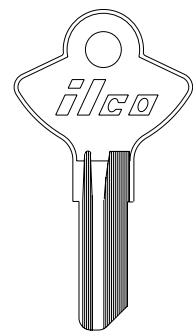
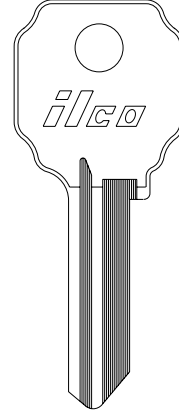
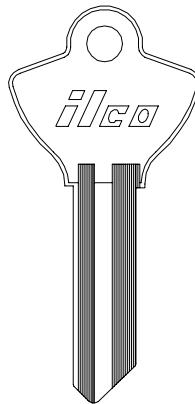
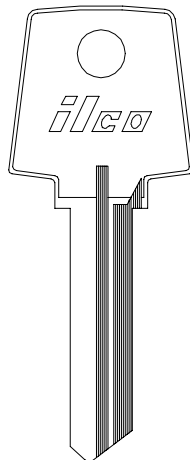
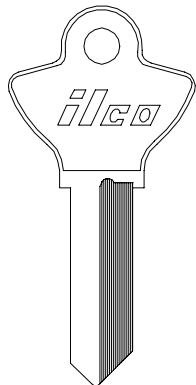
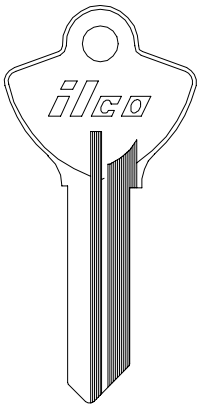

ILCO
EZ
C1096CN
EL10

C1096LN
EL11

L1096CN
EL15

S1096B
EL20

S1096G
-

S1096JN
-



NORTH AMERICAN CYLINDER







ELGIN

ESP

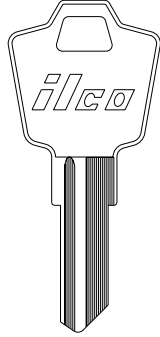

1154C
-



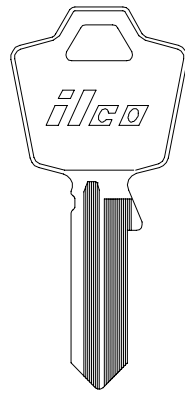

1502
-



1503
ES9

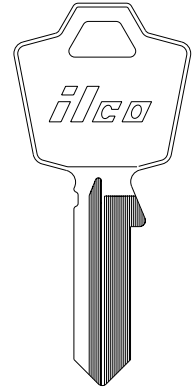

1531
-





1556
- ILCO
EZ

EVERBILT

EXCEL

E-Z GO

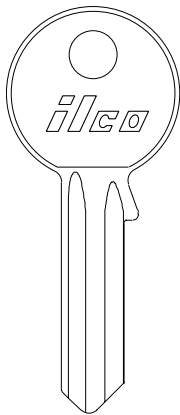
EZ SET



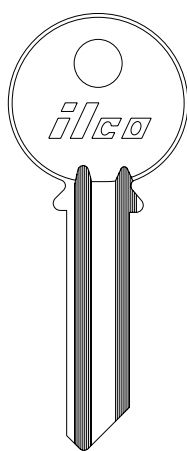

1688
EV1





EX1
-

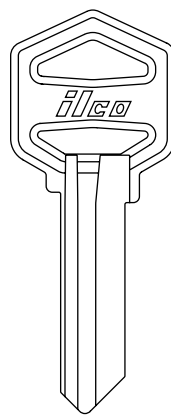



1677
-

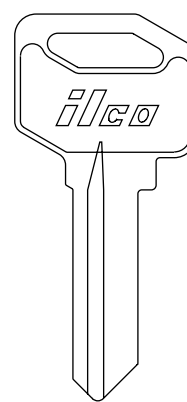

EZ1
KW1



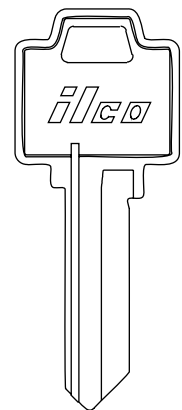

EZ2
SC1



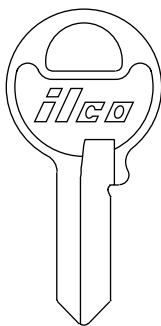

EZ3
WR5 ILCO
EZ

EZ SET

FALCON

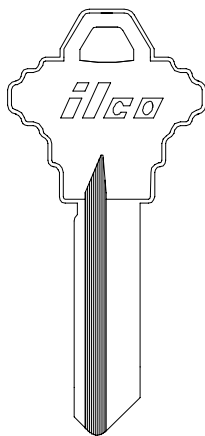

EZ4
M1



EZ5
SC4

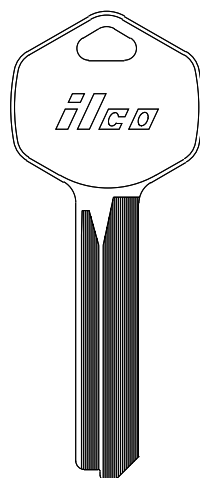

FL1
-

FL2
-

FL3
-

FL4
-

FL5
-



FL6
-



FL7
-

FL8
-

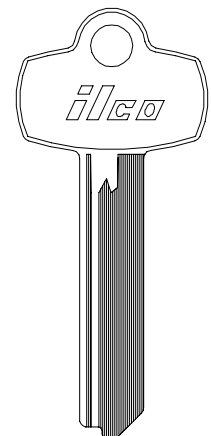

FL9
-

FL10
-

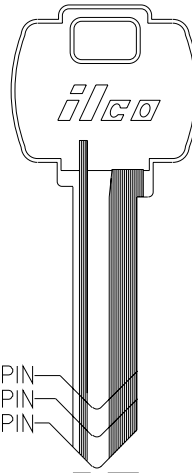
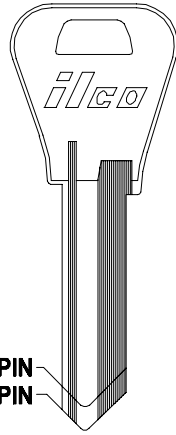
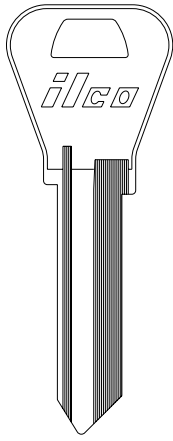

A1114FM
- ILCO
EZ

NORTH AMERICAN CYLINDER



6 PIN
A1054WC
FA2







7 PIN
L1054WC
-

ILCO
EZ



FL5G
-



5 PIN 6 PIN
1054WB A1054WB
WR3 WR4



5 PIN
1054WC
FA1

						
5 PIN	1054WD -	1054WH -	1054WK -	1054WL -	1054WN -	1054WP -
6 PIN	A1054WD -	A1054WH -	A1054WK -	A1054WL -	A1054WN -	A1054WP -
7 PIN	L1054WD -					

	
5 PIN	1054WF -
6 PIN	A1054WF -

	
5 PIN	1054WJ -
6 PIN	A1054WJ -

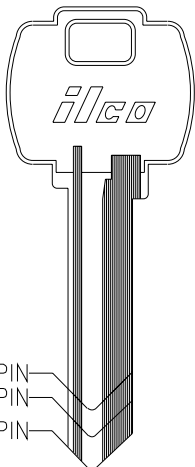
	
5 PIN	1054WR -
6 PIN	A1054WR -





FANAL

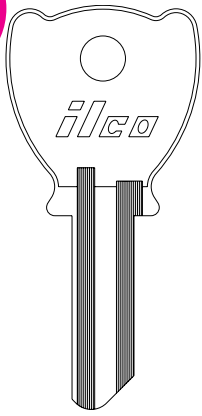

1551
-

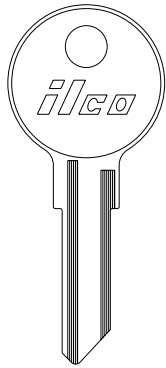

1552
-

FIC

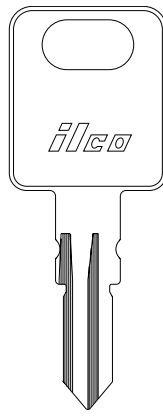

1681
FIC3

FIRST WATCH

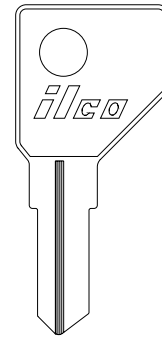

1671
-

FORT



M54G **ILCO**
- **EZ**

FORT

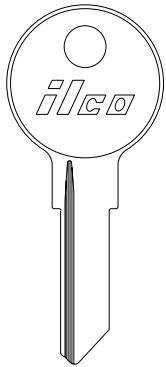

ML54G
-

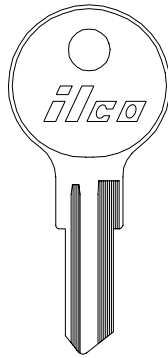

N54G
-

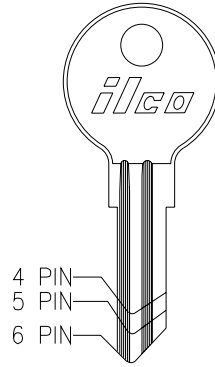

S54G
4-PIN

5 PIN
1054G
-

6 PIN
L1054G
-

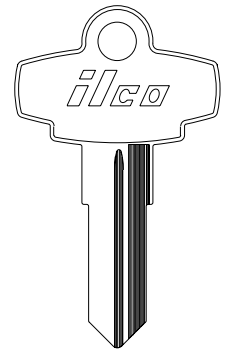

752 **ILCO**
- **EZ**

FORT

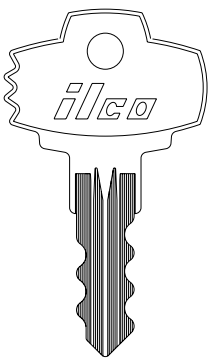

757
-

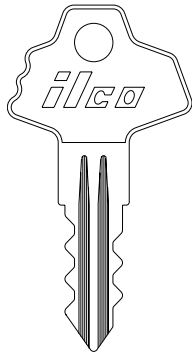

750
-

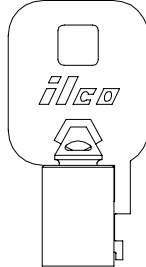

OD .377" - 0.6mm
ID .312" - 7.9MM
(BRASS)
1137B
-

FRAIM

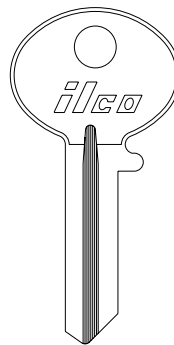

1073
-

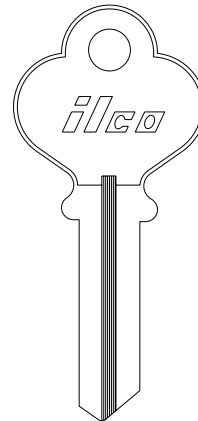

1073K
-

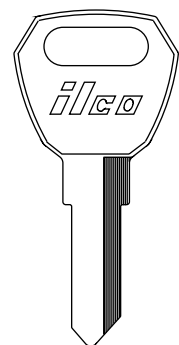

1645 **ILCO**
- **EZ**

NORTH AMERICAN CYLINDER

SEC 2
PG 240



FULTON HITCH GATEHOUSE GENERAL

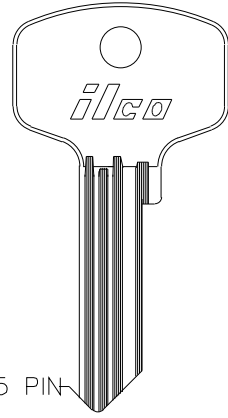
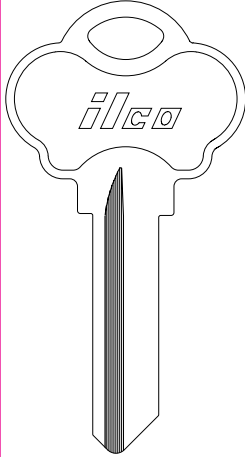
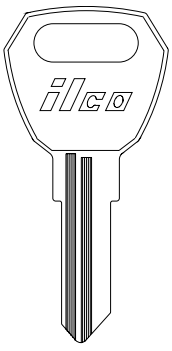

5 PIN

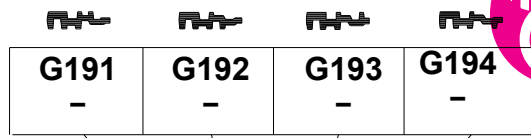

ILCO
EZ 1645R
-

1682
GH5

GUARD SECURITY

GENERAL

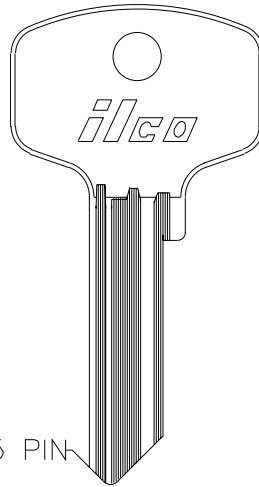
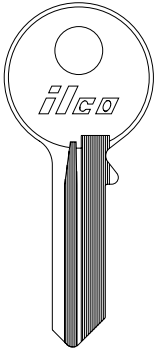

5 PIN

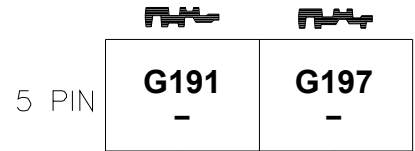

ILCO
EZ 1672
-

GENERAL

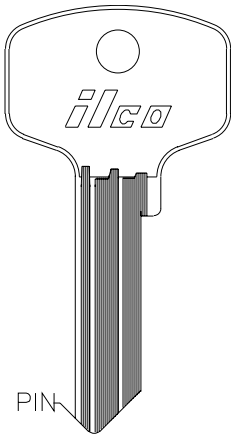

5 PIN

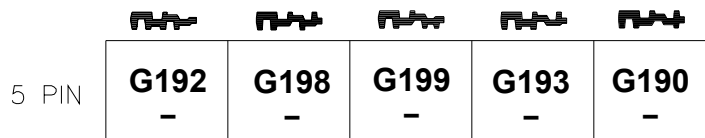

ILCO
EZ



NORTH AMERICAN CYLINDER



GENERAL

GENERAL FIRE PROOF SAFE

HAFELE

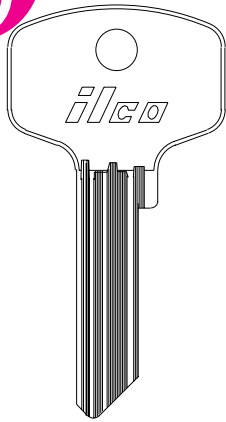

G194
-

G197
-

G199
-

G190
-

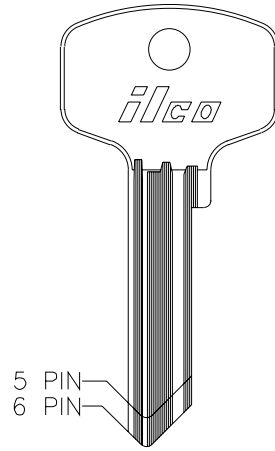

G190M **G190MA**
-

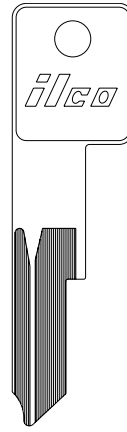

GF1069
-

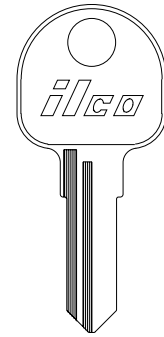

1670
-

ILCO
EZ

HARLOC

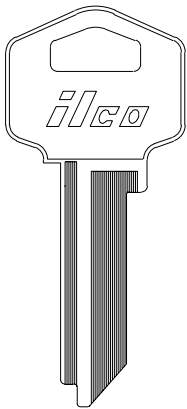

TE3
HR2

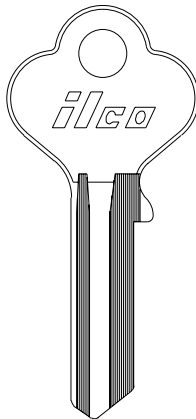

1014B
-

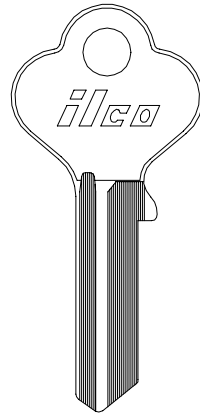

1014C
HR1

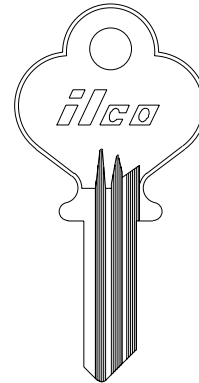

1041D
-

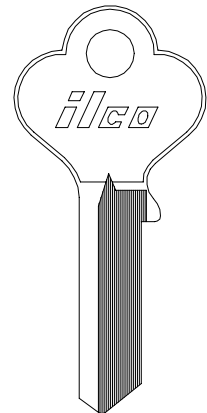

X1014F
EA27

ILCO
EZ

HAYWORTH

HUBER

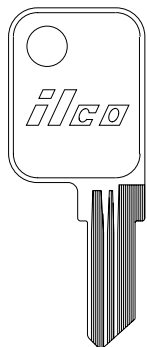

1597
HAW1

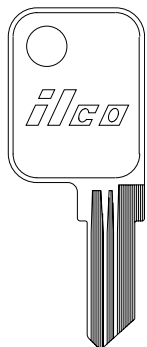

1598
HAW2

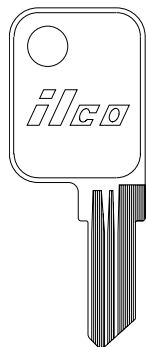

1599
HAW3

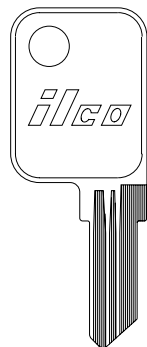

1600
HAW4

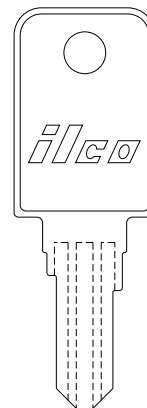

1683
HAW5

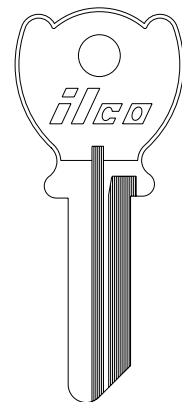

1020
-

ILCO
EZ

NORTH AMERICAN CYLINDER



HICKORY/FIRSTWATCH

HUDSON

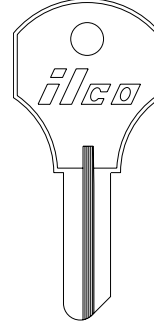
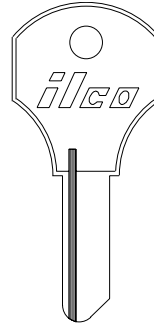
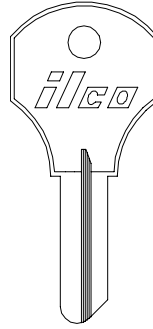
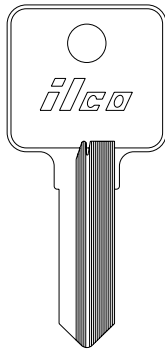
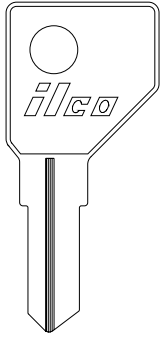

ILCO 1671
EZ -



HL3
-



S1000V
CO68



1000V
CO26



1000X
CO63



1000XK
-

HUDSON

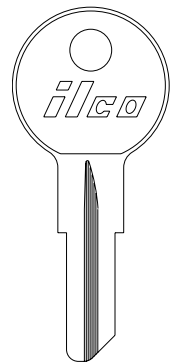
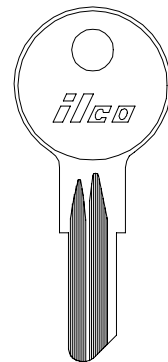
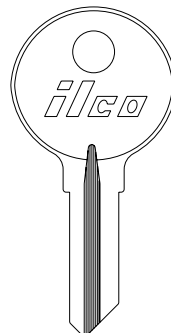
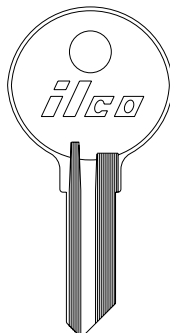
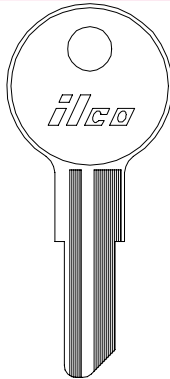
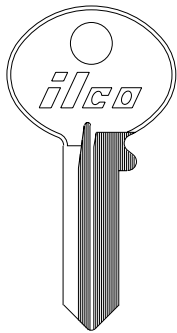

ILCO 1003M
EZ CO106



R1003M
BO1



1041T
CG16



1069
RO1



1069B
-



1098DB
B5



1098X
-

HUDSON

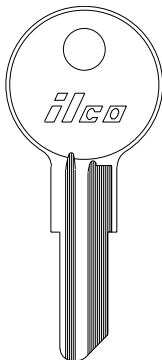

O1122A
Y12

O1122AR
-

O1122B
Y103

O1122BR
-

O1122BE
-

O1122C
-

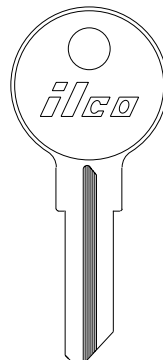

1562
-

1563
-

1564
-



ILCO O1122 O1122R
EZ Y11 Y13



1561
-



1525
-





HUMANE RESTRAINT HURD

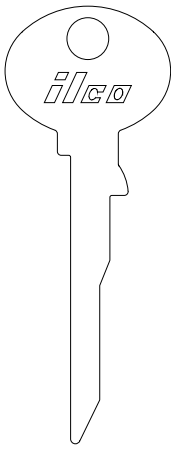

1673
-

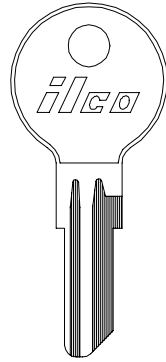

O1122A
Y12

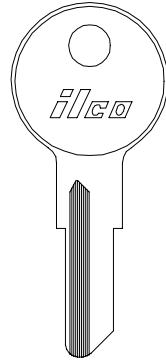

O1122B
Y103

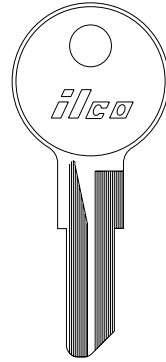

O1122C
-

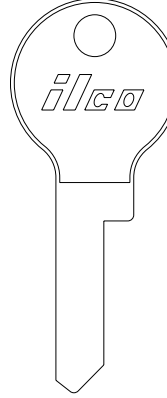

1125
H6

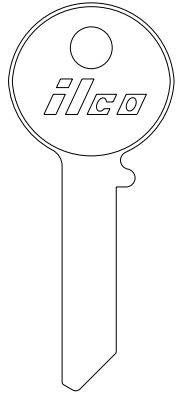

1125A
-

ILCO
EZ

HURD

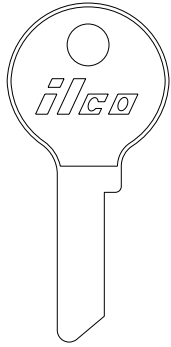

1125D
-

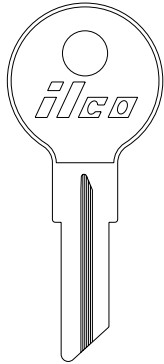

1125X
-

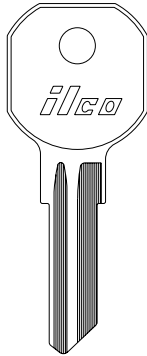

1536
-

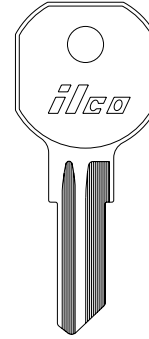

1536R
-

1574 **1574R**
- -

IDEAL

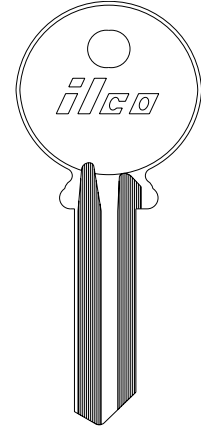

ID1
-

ILCO
EZ

IDEAL

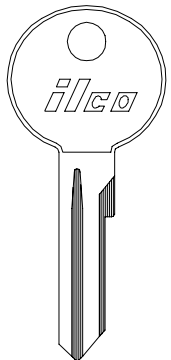

IS1
-



64D
-

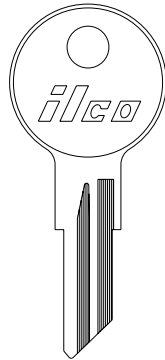

64RD
-

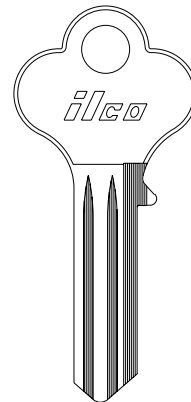

64G
-

ILCO

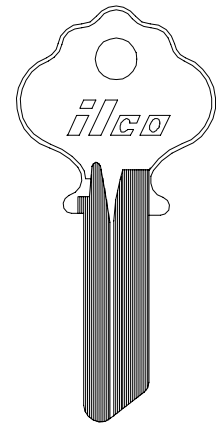

1054
IN2

ILCO
EZ

NORTH AMERICAN CYLINDER



ILCO

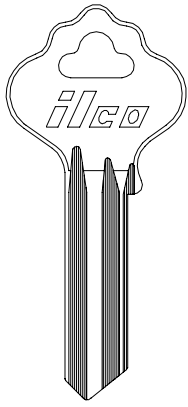

ILCO 1054DL
EZ IN35

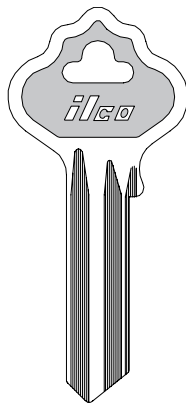

IN35-PC
-

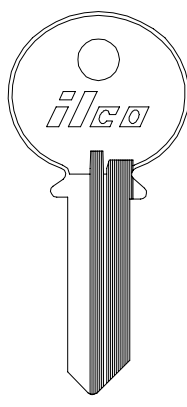

1054F
IN1

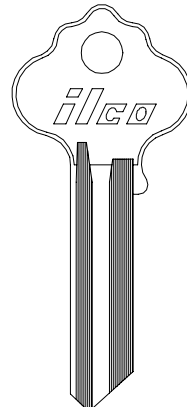

1054FN
IN28

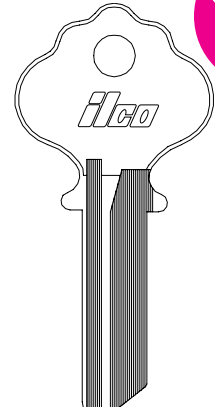

1054K
-

ILCO

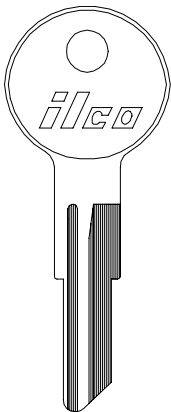

ILCO 1054LB
EZ IN4

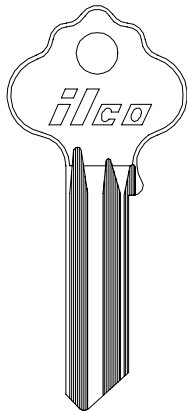

1054MT
IN33

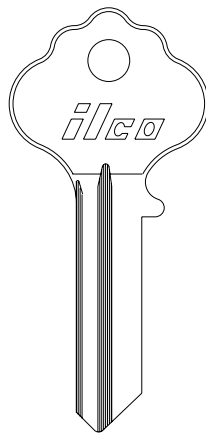

1054R
-

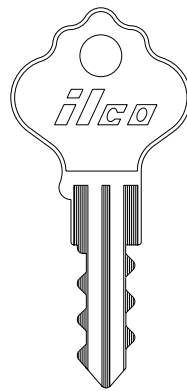

1054N
-

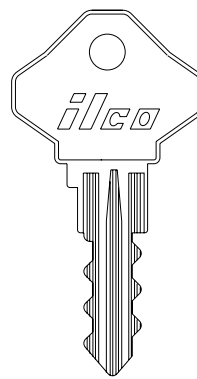

1054P
-

NOTE: This special blank is not a cut key. It is to be used the same as regular blanks for duplicating, cutting from code or from depth keys. It will save the locksmith 80% of his work, and the key can be cut more accurately and in less time. After cutting the special blank, when compared with the original keys, they will not be exactly alike in the pass cut positions, but this is not important as long as they match with the original where the tumblers rest on the key.

ILCO

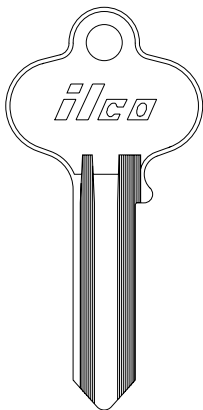

ILCO 1054TW
EZ IN34

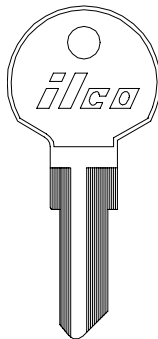

1054UN
IN29

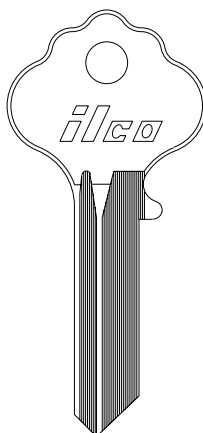

1054X
-

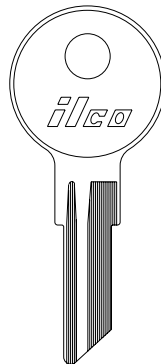

B1054B
-

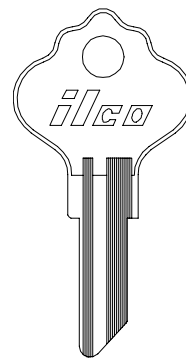

H1054B
EL8

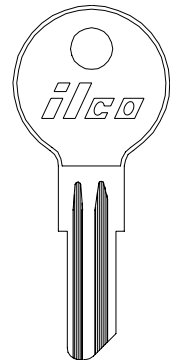

H1054S
-





ILCO

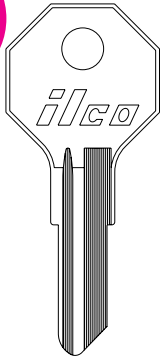

H1054L
-

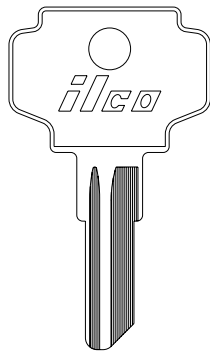

K1054B
IN24

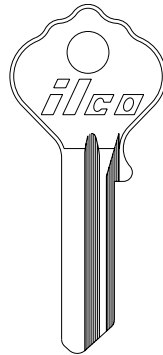

L1054AR
-

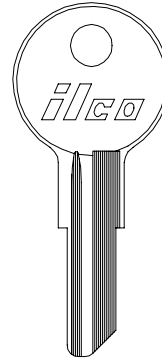

L1054B
IN8

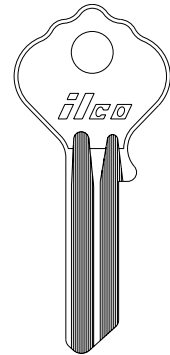

L1054JA
-

ILCO
EZ

ILCO

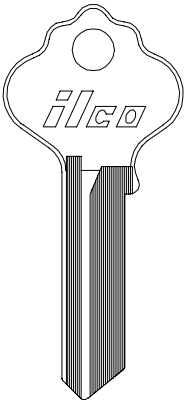

N1054K
IN36

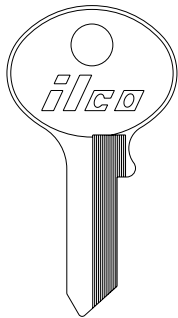

X1054C
-

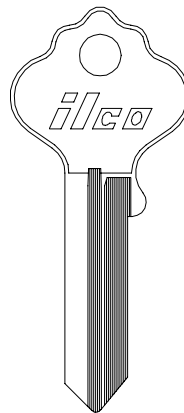

X1054F
IN18

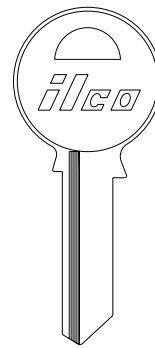

X1054GC
-

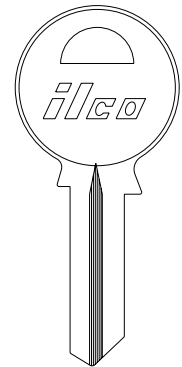

X1054GD
-

ILCO
EZ

ILCO

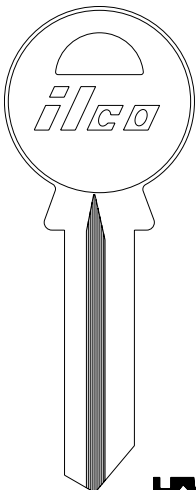

X1054GF
-

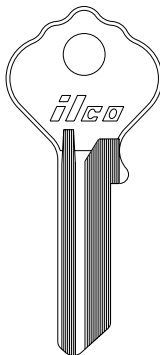

X1054JA
-

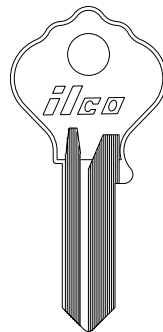

X1054JK
-

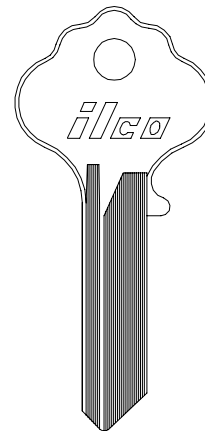

X1054K
IN3

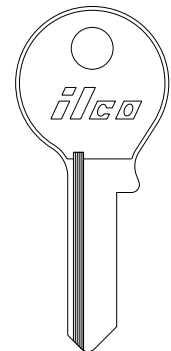

X1054SC
-

ILCO
EZ

NORTH AMERICAN CYLINDER



ILCO

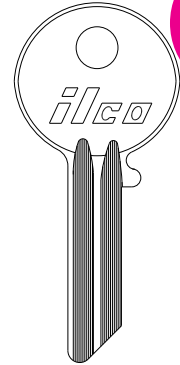
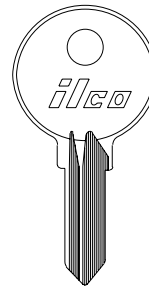
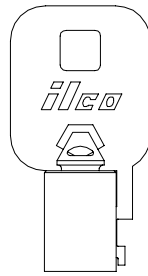
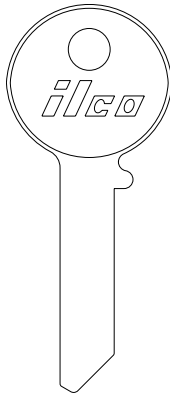
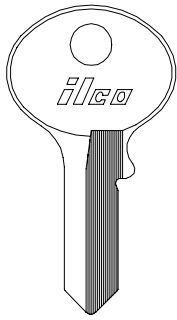

OD .377" - 0.6mm
ID .312" - 7.9MM
(BRASS)

ILCO 1092TG-ILCO
EZ -

1125A
-

1137B
-

1154C
-

1154G
-

ILLINOIS

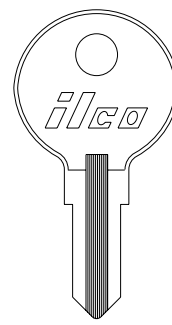
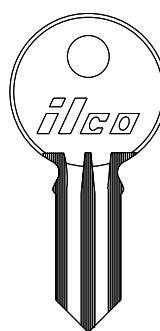
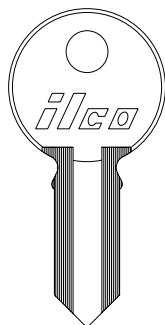
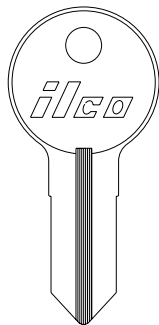

ILCO ILL1
EZ -

ILL2
-

1041H IL1
-

1041HM
-

1041P
-

1041S
-

ILLINOIS

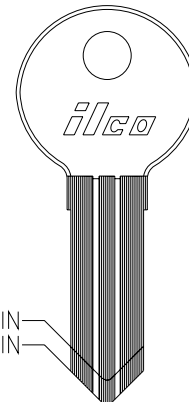
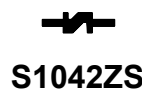
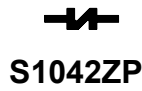
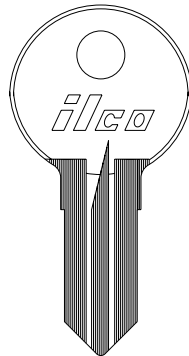
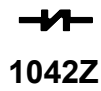
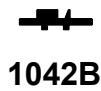
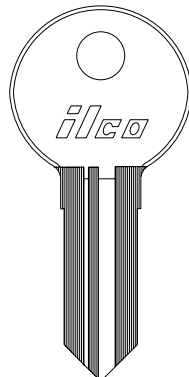
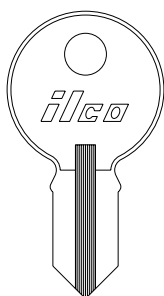

5 PIN

1042WC
-

5 PIN
6 PIN

ILCO S1041H
EZ -

1042A
-

S1042Z
-

5 PIN 6 PIN
L1042A L1042B
-





ILLINOIS

IMPORT

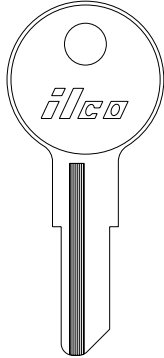
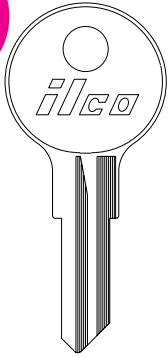

H
1043C
-
S
1043D
-
N
1043E
-

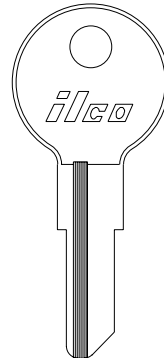
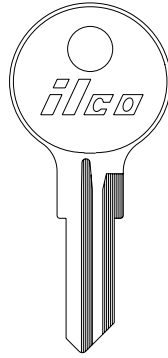

N
1043ED
-

H
1043B
IL9

S
1043G
-

W
1043F
-

H
1043J
IL11

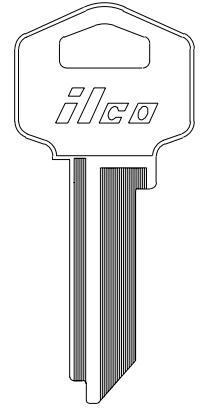

M
TE3
HR2

ILCO
EZ

IMPORT

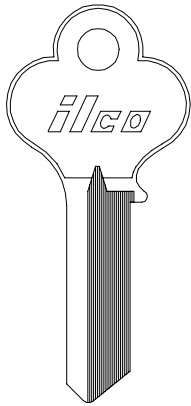

W
X1014L
LO1

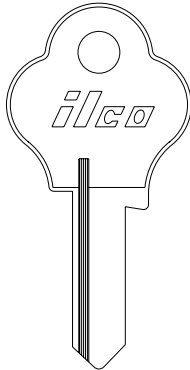

H
1528
-

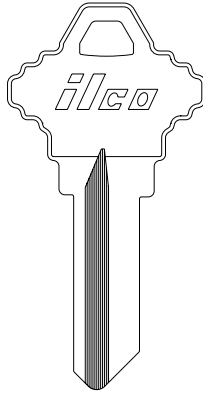

S
1528R
-

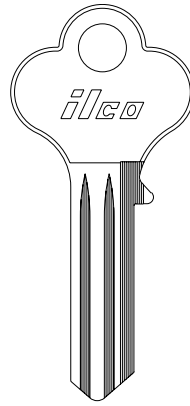

W
1537
CLP1

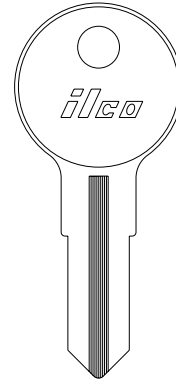

S
1538
-

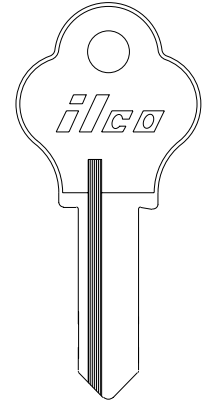

S
1541
-

H
1566
-

ILCO
EZ

IMPORT

KEIL

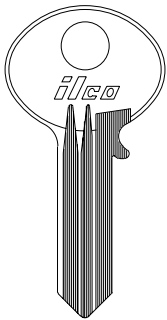

W
1571
-

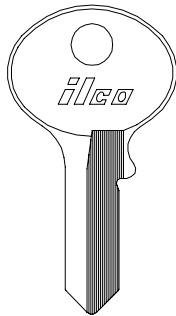

S
1092TG-ILCO
-

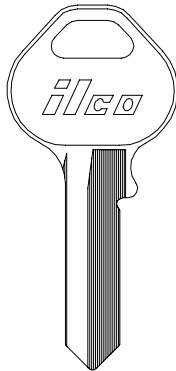

S
1092NTG
-

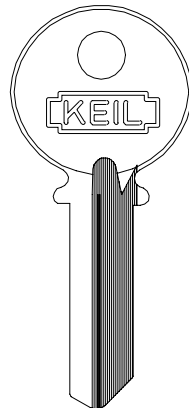

W
1079
K1

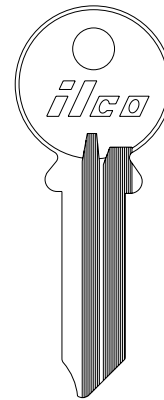

S
1079AB
-

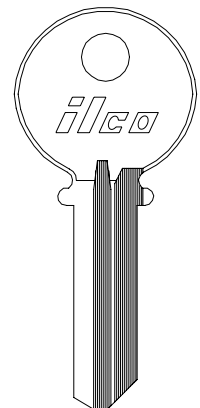

S
1079B
K2

ILCO
EZ

NORTH AMERICAN CYLINDER



KIMBALL

KRYPTONITE KWIKSET

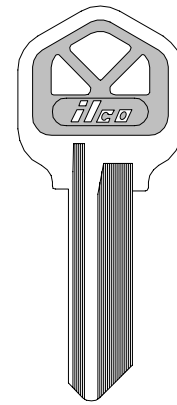
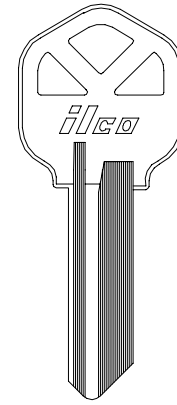
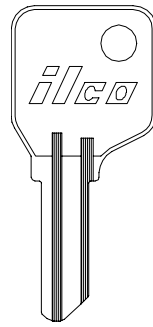
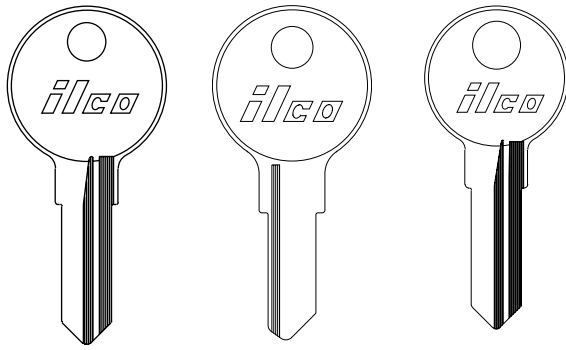

ILCO	1649	1654	1663
EZ	KB1	KB2	KB3

	1567	1176
	-	KW1
		KW1-PC
		-

KWIKSET

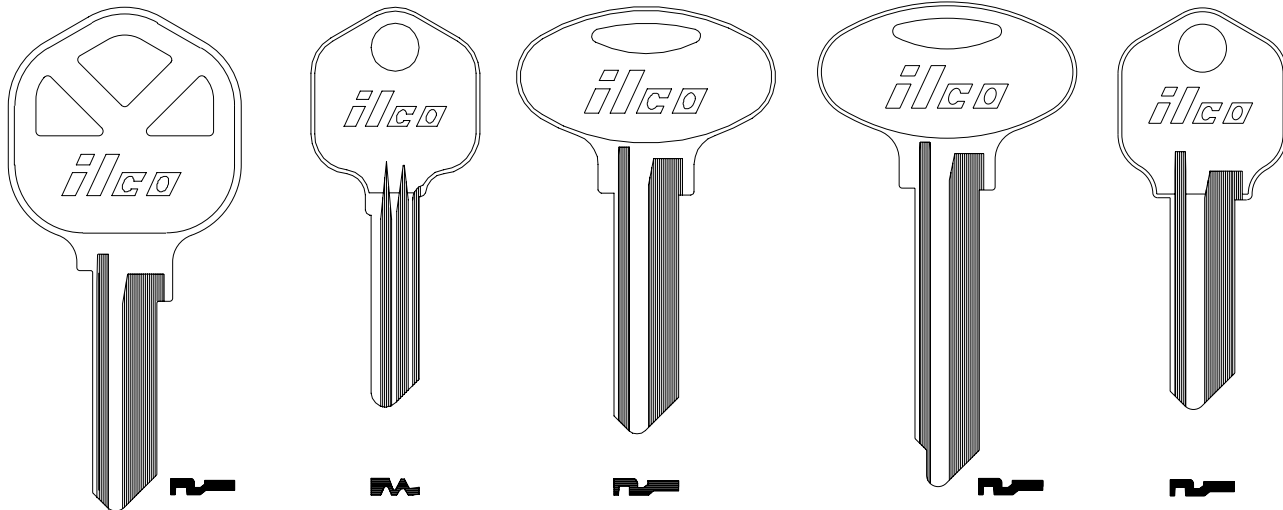

ILCO	KW1-BIG	1176D	A1176	CR1176	S1176
EZ	-	-	KW5	-	-

KWIKSET

LAGARD

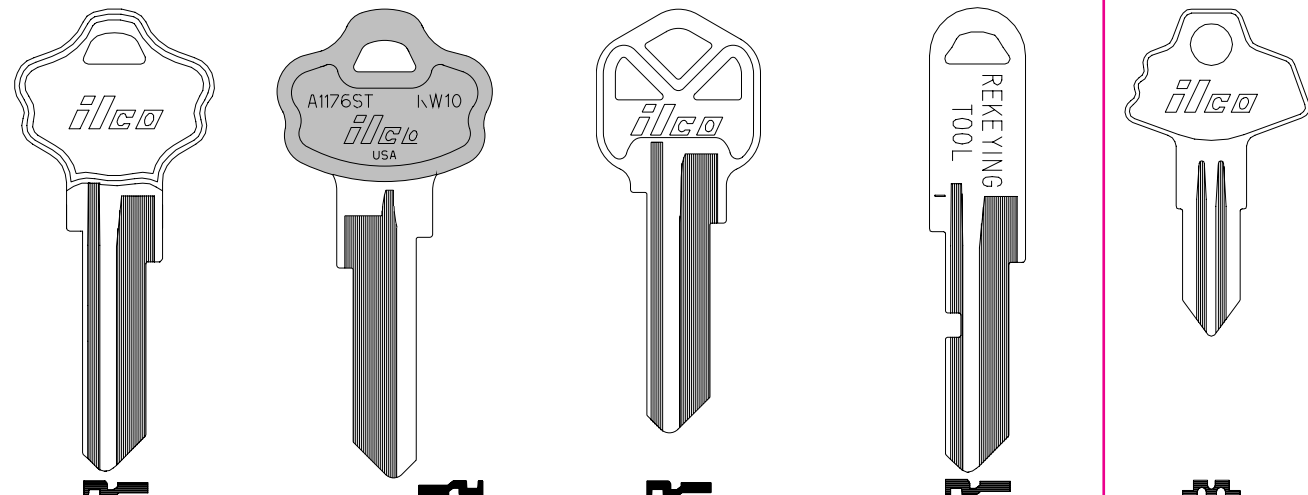

ILCO	A1176ST	KW10-PC	A1176KT	1176RK	S900
EZ	KW10	-	KW11	-	-



NORTH AMERICAN CYLINDER



LANE CEDAR CHEST

LARSON DOOR

LOCK MEXICO

LOCKWOOD

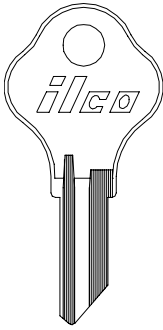

LC1069
-

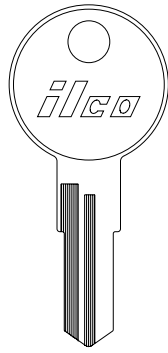

1639
LD1

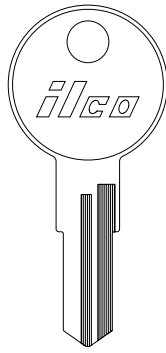

1640
LD2

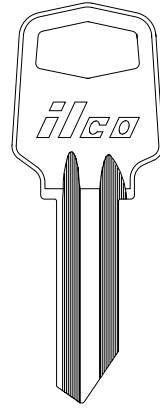

1585
-

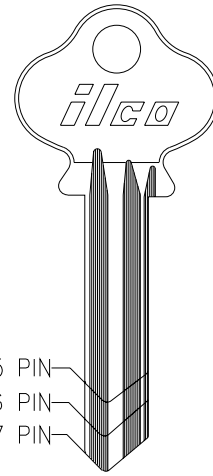

1004A
L4

1004AL
-

1004
L1

ILCO
EZ

LOCKWOOD

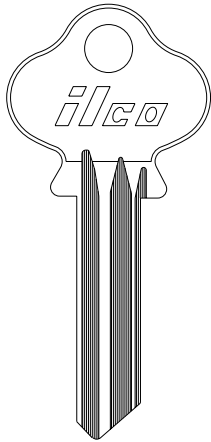

1004AXM
-

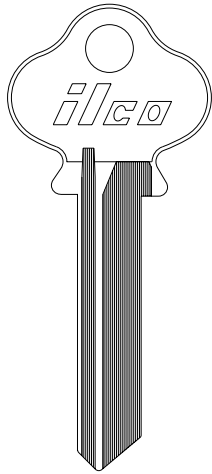

1004KL
-

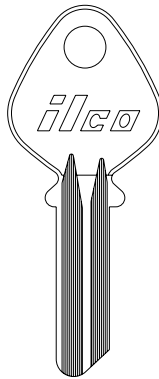

1004M
-

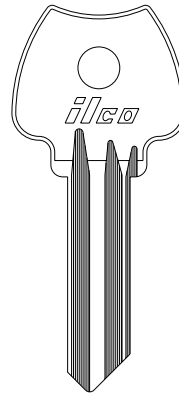

1004N
L13

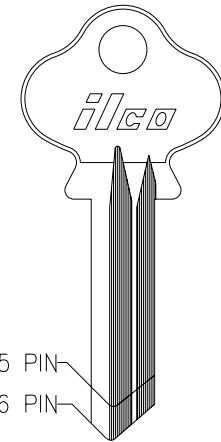

1004R **1004AR**
- -

ILCO
EZ

LOCKWOOD

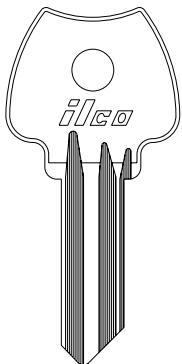

1004SN
-

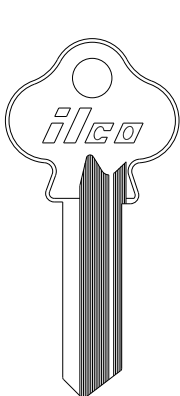

1005
L2

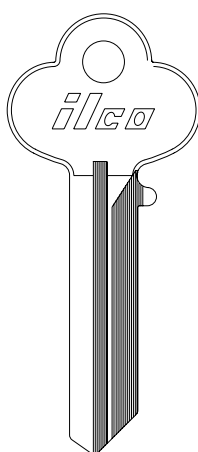

1015
-

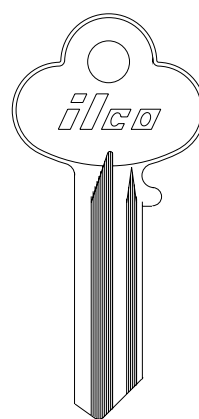

1015C
-

ILCO
EZ



NORTH AMERICAN CYLINDER

LOCKWOOD

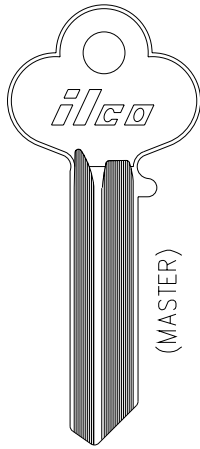

A1015L	A1015R	A1015V	-
-	-	-	-
A1015N	A1015S	A1015W	-
-	-	-	-
A1015P	A1015T	A1015X	-
-	-	-	-
A1015Q	A1015U	A1015Y	-
-	-	-	-

ILCO
EZ
A1015M
6 PIN

(MASTER)

LOCKWOOD

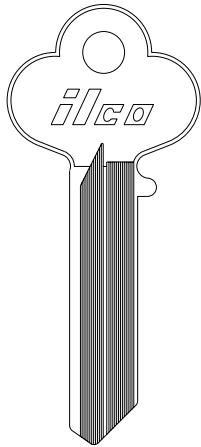

A1015LR	A1015RR	A1015VR	-
-	-	-	-
A1015NR	A1015SR	A1015WR	-
-	-	-	-
A1015PR	A1015TR	A1015XR	-
-	-	-	-
A1015MR	A1015QR	A1015UR	A1015YR
-	-	-	-

ILCO
EZ
A1015MR

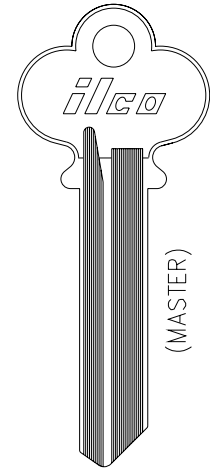

L1015M L1015MR

(MASTER)

LORI

MASTER

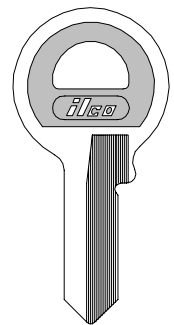
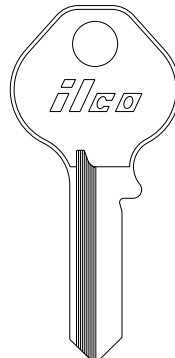
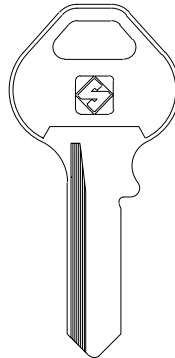
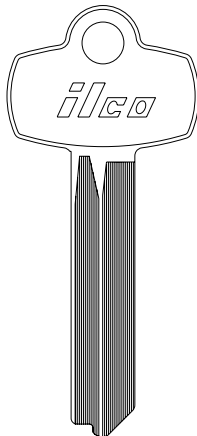
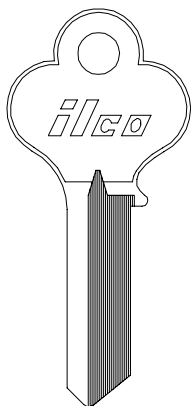

ILCO
EZ
X1014L
LO1

1615

MS4R

MA7

1092
M1

1092R

M1-PC





NORTH AMERICAN CYLINDER



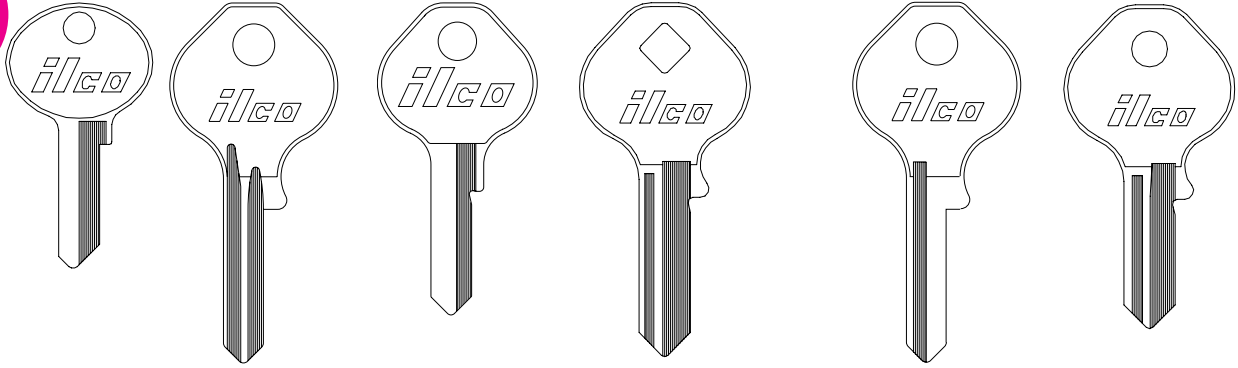

MASTER



							
1092B	1092C	1092CNTLBI	1092D	1092DD	1092E	1092DS	ILCO
M2	M17	-	M12	-	-	M13	EZ



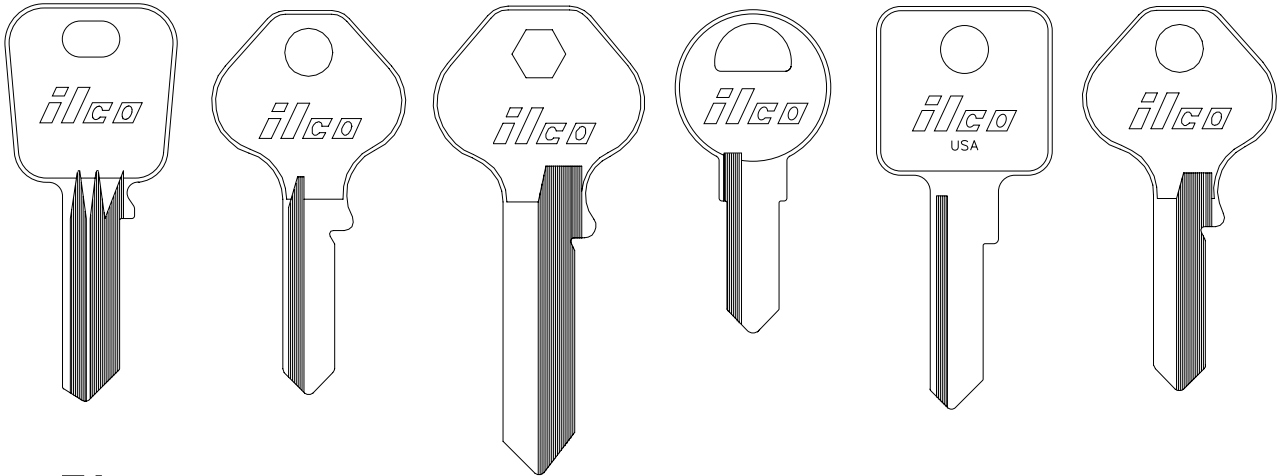



MASTER



						
1092F	1092H	1092J	1092K	1092M	1092N	ILCO
M27	M11	M14	M28	M29	M10	EZ

MASTER





							
1092NR	1092V	1092VA	1092VR	1092VB	1092VM	1092-40	ILCO
M16	M4	-	M3	-	M5	M18	EZ

NORTH AMERICAN CYLINDER

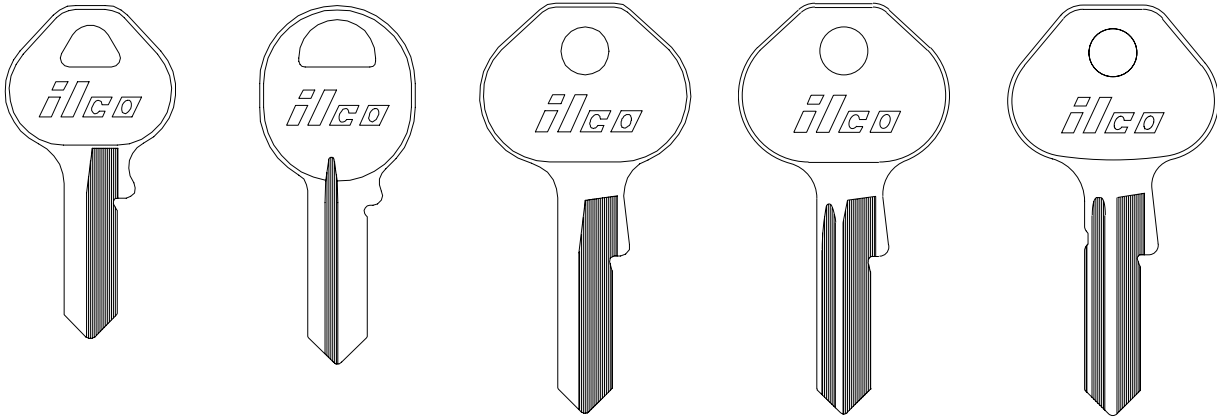

MASTER







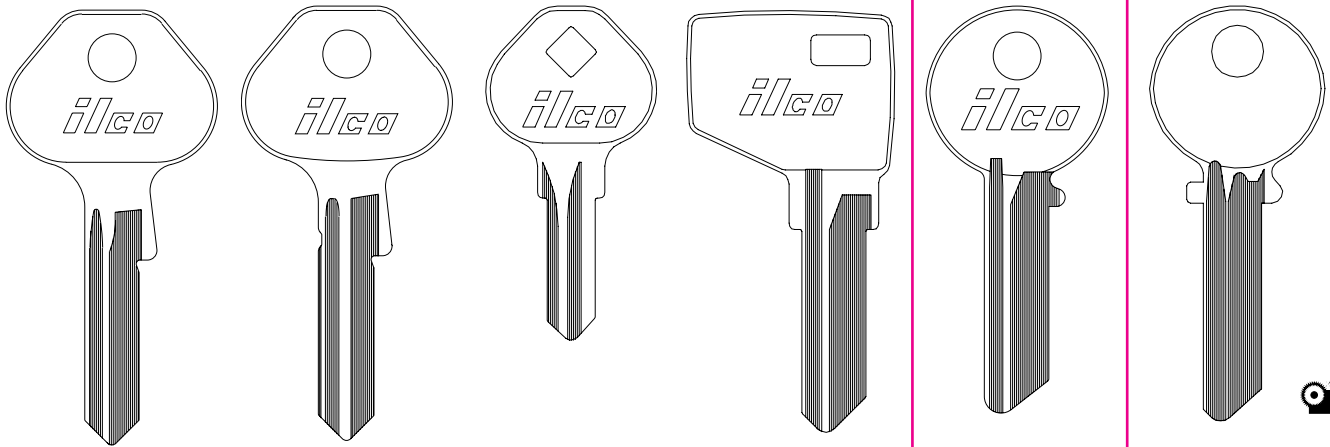

					
ILCO EZ	1092-52 -	1092-600A -	1092-900 M19	1092-6000 M20	1092-6000B M25

MASTER

MCKINNEY

MEDECO



						
ILCO EZ	1092-7000 M21	1092-7000B M26	1092-8105 -	MD1054K MD17	O1054KR -	1515 -

MEDECO * (Compatible)

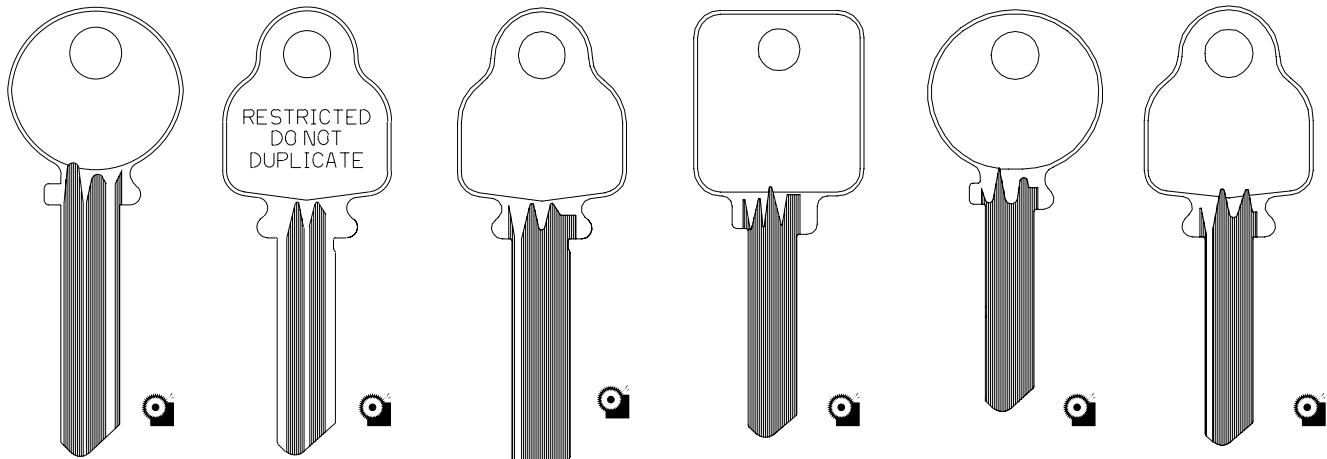

						
ILCO EZ	A1515 -	1517 -	A1517 -	1518 -	1542 -	1543 -

NORTH AMERICAN CYLINDER



*Medeco is a trademark of a third party not affiliated or linked with Kaba Ilco or the Dormakaba Group.



MEDECO * (Compatible)

MEDECO PATRIOT

METAL ROUSSEAU

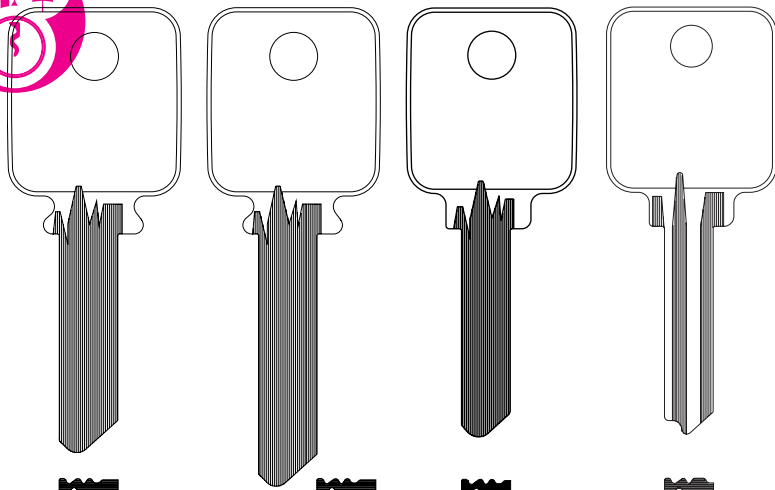

1638

A1638

1644

1655

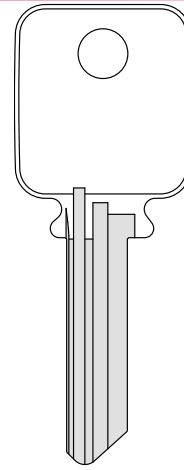

1687

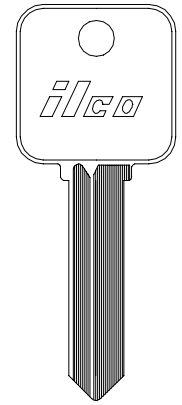

MR1

ILCO
EZ

NORTH AMERICAN CYLINDER

METAL ROUSSEAU

MINTCRAFT PADLOCK

NATIONAL CASH REGISTER

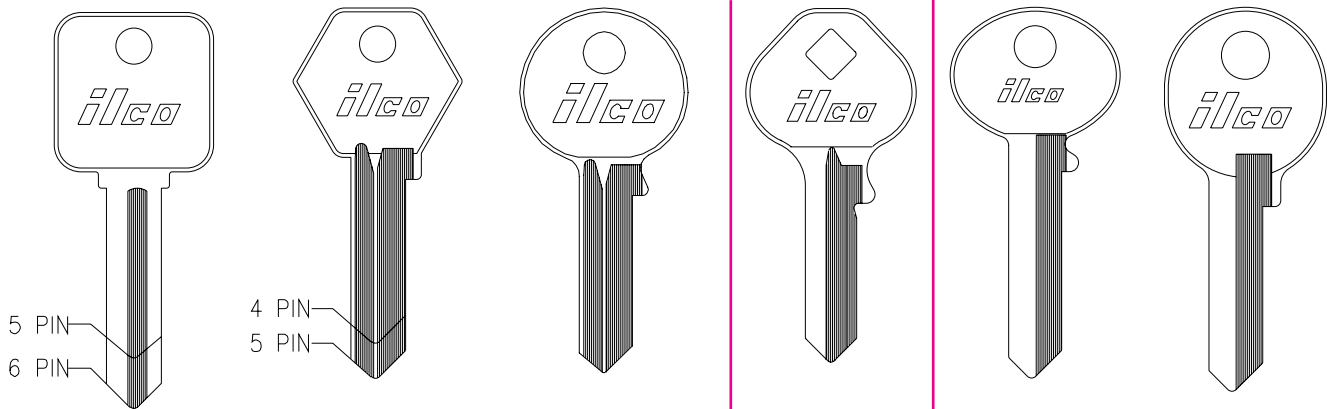

5 PIN
6 PIN

4 PIN
5 PIN

5 PIN
MR3

6 PIN
MR2

4 PIN
H64S

5 PIN
H64

M64

1643

X1000FR

1083

ILCO
EZ

NATIONAL CASH REGISTER

NCL



1083H

1083J

1177

1177A

1177N
NH1

1028NR

ILCO
EZ

SEC
2
PG
254

*Medeco is a trademark of a third party not affiliated or linked with Kaba Ilco or the Dormakaba Group.



NCL / NATIONAL CABINET

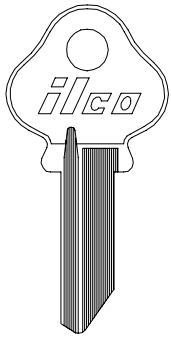

ILCO
EZ 1064
NA1

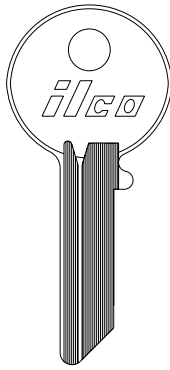

1064A
-

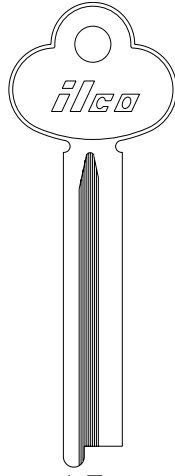

1064L
-

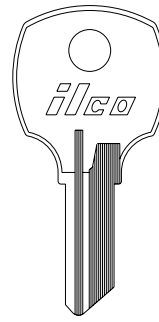

1064M
-

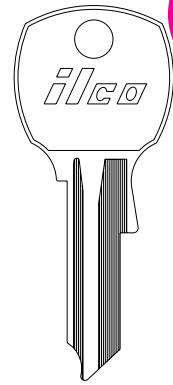

S1064A
-

NCL / NATIONAL CABINET



ILCO
EZ 1065
-

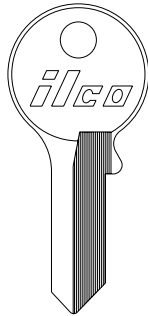

1065C
-

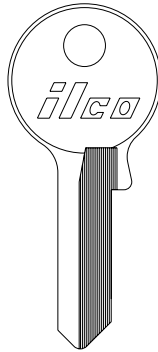

1065D
-

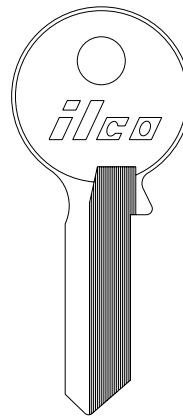

1065E
-

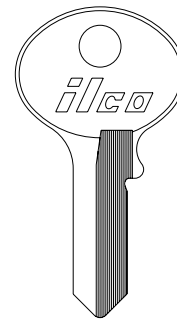

1065F
-

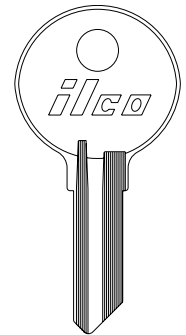

1069
RO1

NCL / NATIONAL CABINET

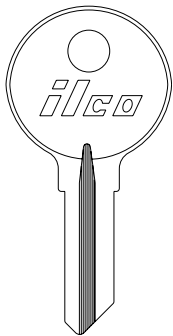

ILCO
EZ 1069B
-

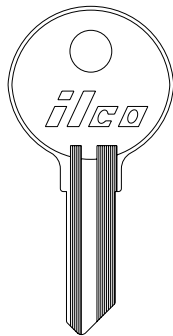

1069C
-



1069D
-

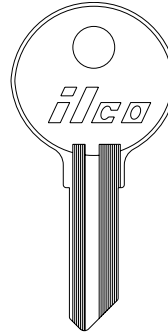

1069E
-

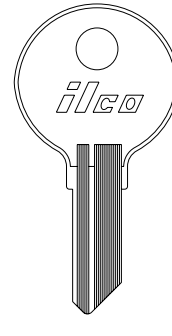

1069F
-

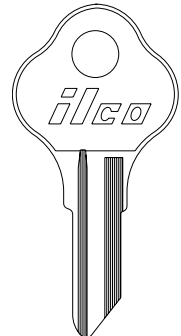

1069FNA
-







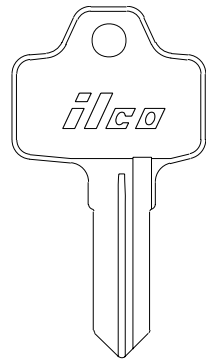
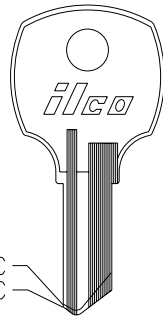
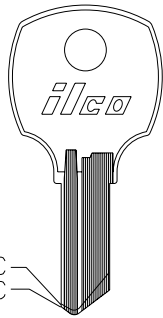
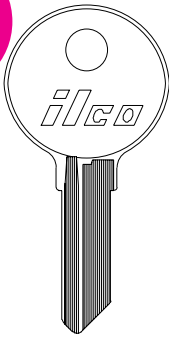

NCL / NATIONAL CABINET



1069FL
RO4

S1069G
- 1069G
RO7



4 DISC 5 DISC
S1069H 1069H
- RO11

 
1069L R1069L
NA14 -

1692
NA15

ILCO
EZ

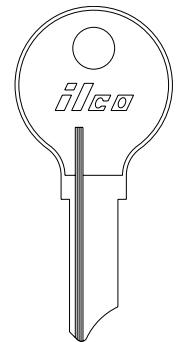
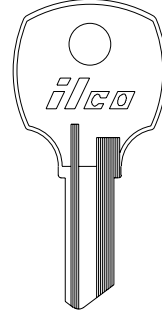
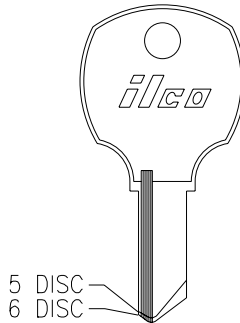
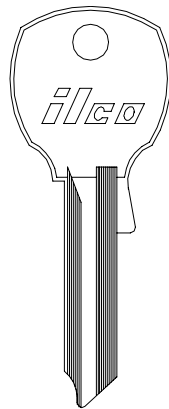
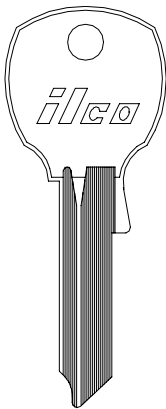
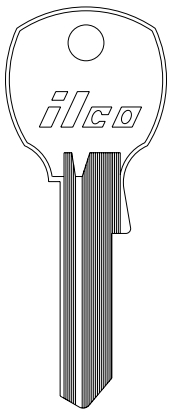
NCL / NATIONAL CABINET



1069LA
-

1069LB
NA12

1069LC
NA24



5 DISC 6 DISC
S1069M 1069M
- RO5

1069N
RO3

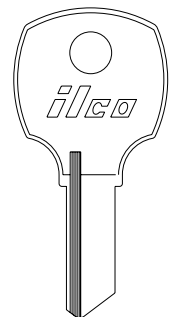
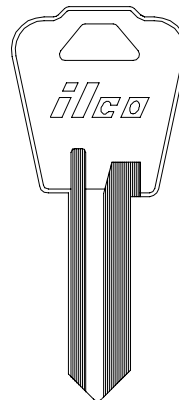
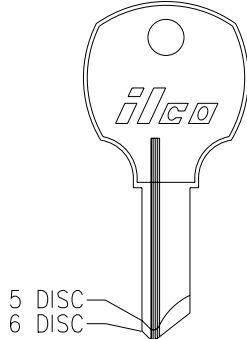
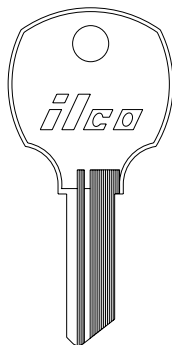
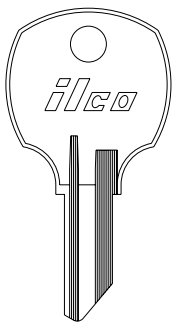

1069P
-

ILCO
EZ

NCL / NATIONAL CABINET





1069S
-

1069SM
-

5 DISC 6 DISC
S1069T 1069T
- -



1069W
NH1

1069YM
-

ILCO
EZ

NORTH AMERICAN CYLINDER

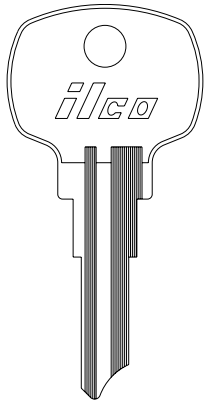
NCL / NATIONAL CABINET



1069-5Y
-

1069-5Z
-

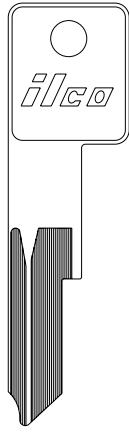

GF1069
-

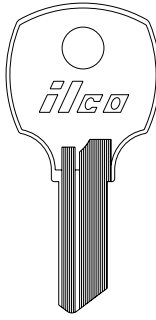

M1069C
-

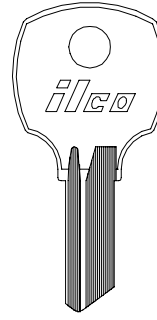

M1069L
-

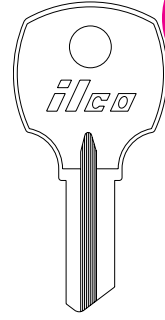

N1069B
RO13

ILCO
EZ **1069-5X**
-

NCL / NATIONAL CABINET

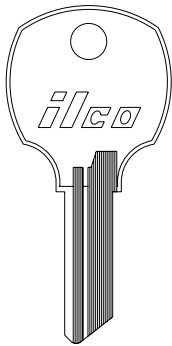

N1069C
-



N1069E
-

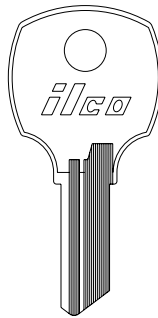

N1069G
-

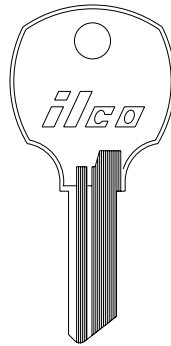

N1069J
-

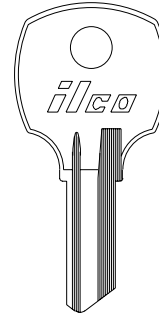

N1069N
RO15

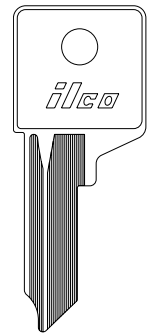

1544
-

ILCO
EZ

NCL

NATIONAL LOCK HARDWARE

NORWALK

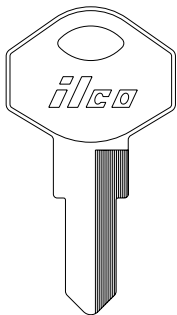

1545
-

ILCO
EZ

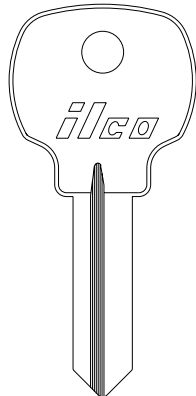

1064D
-

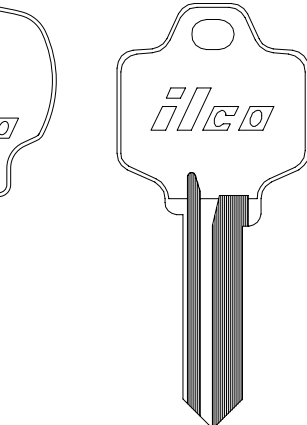

R1064D
NA6

R1064E
NA25

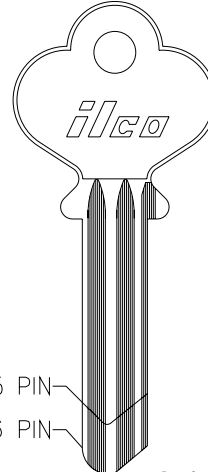

5 PIN
1017
N1

6 PIN
1017A
-

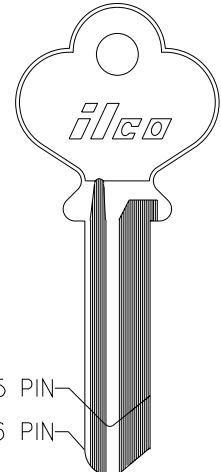

5 PIN
1017B
N3

6 PIN
1017BA
-



NORTH AMERICAN CYLINDER



NORWALK PENN

PETERBORO

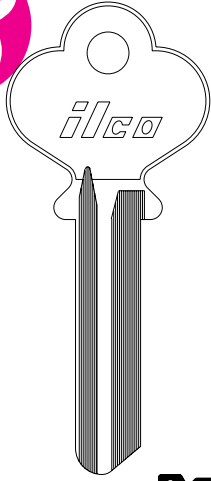

O1017ML
-

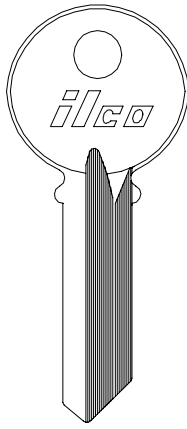

1016
P1

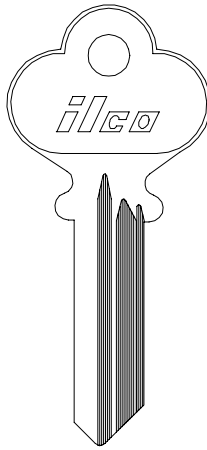

1016N
P2

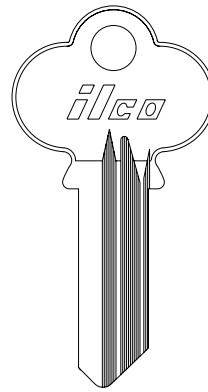

1016NB
-

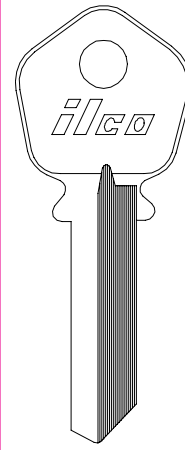

1034
-

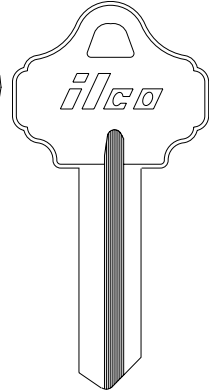

1034H
-

ILCO
EZ

PETCO

PHILLIPS

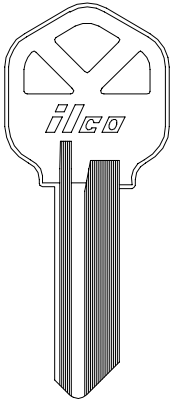

1176
KW1

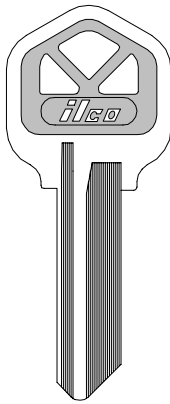

KW1-PC
-

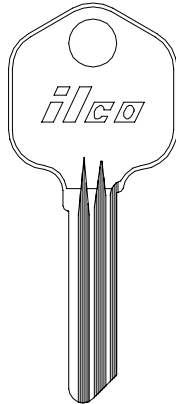

1176D
-

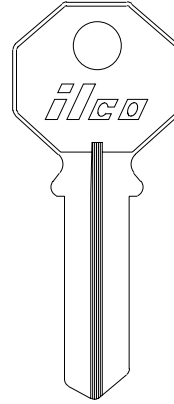

A1
-

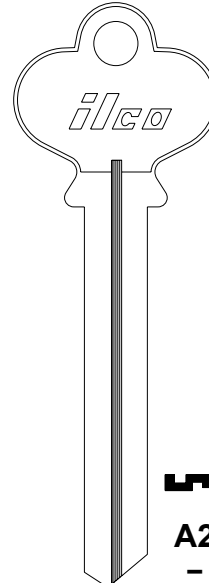

A2
-

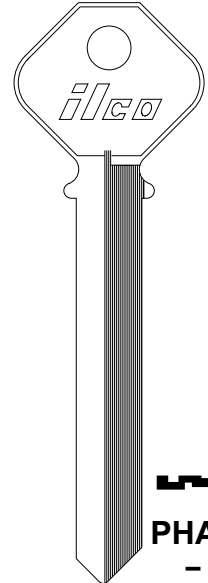

PHA2 ILCO
- EZ

PHILLIPS

PUNDRA

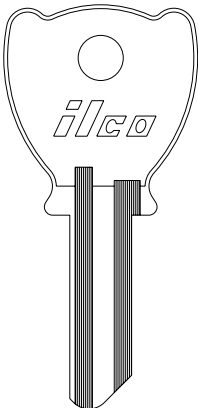

A3
-

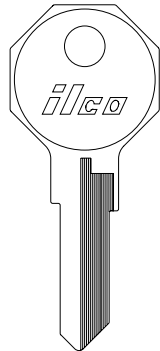

PH32
-



PU1
-

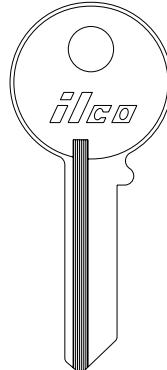

PU2
-

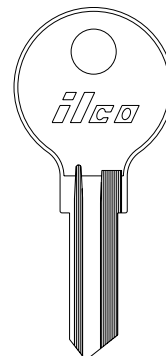

PU3
-

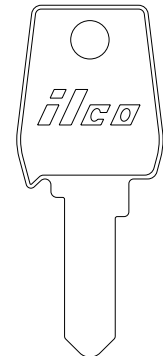

PU4
-

ILCO
EZ

NORTH AMERICAN CYLINDER

PUNDRA

RAD

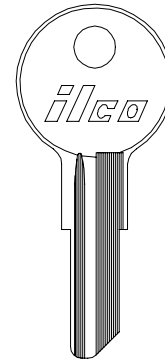
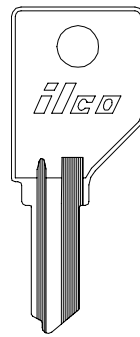
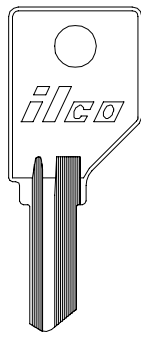
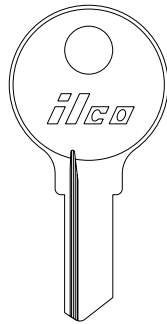
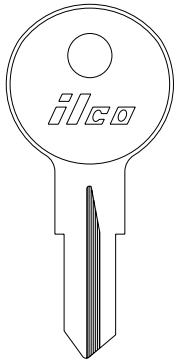

ILCO
EZ
PU5
-

1866-4
-
1866-7
-
1866-10
-

1866-13
RO13

L1054B
IN8

READING

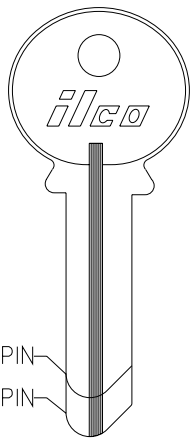

5 PIN

1019R
-

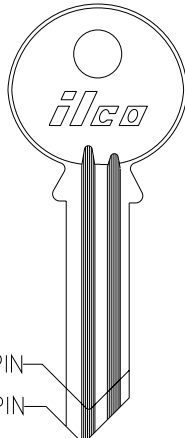
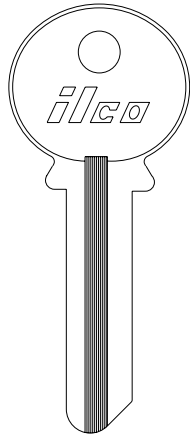

5 PIN
6 PIN

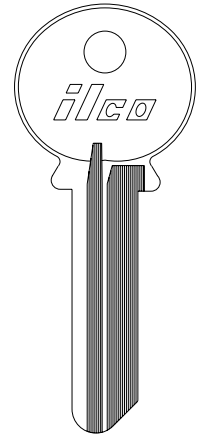
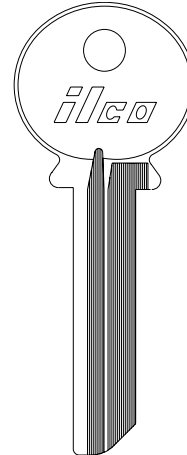

5 PIN
6 PIN



5 PIN 6 PIN



5 PIN 6 PIN



ILCO
EZ
1019
RE1
1019A
-

1019C
-

1019D
-
1019DA
-

1019XL
-

A1019M
-

READING

REESE

RICHILIEU

RUSSWIN

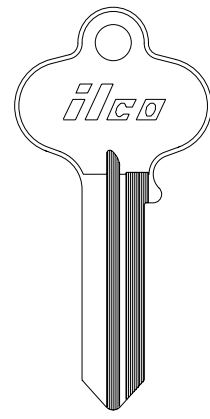
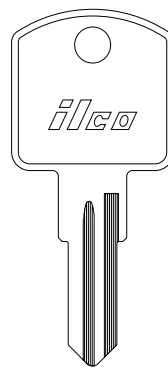
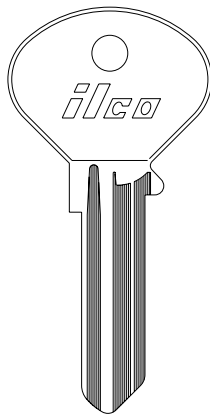
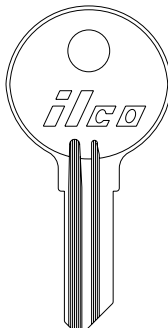
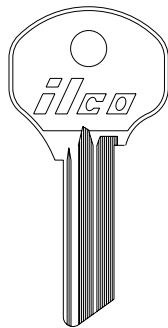
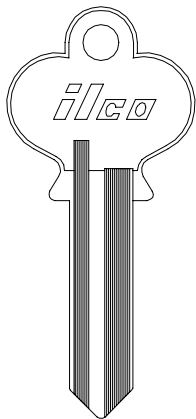

ILCO
EZ
1119
ER1

1140G
R3

1140P
-

1146
-

1668
-

1011
RU1





RUSSWIN (now Corbin/Russwin)

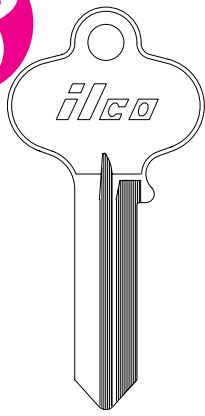

1011A
-

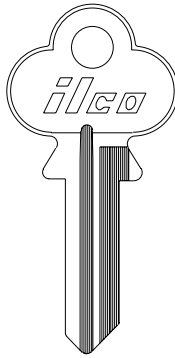

1011B
RU3

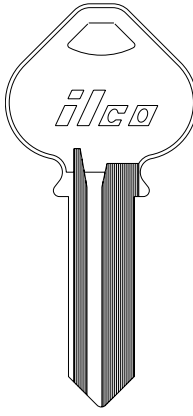

1011GH
RU44

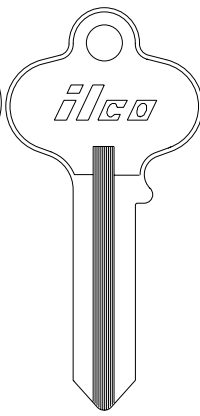

1011M
-

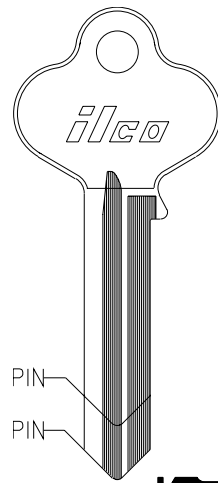

1011P 5 PIN
RU4

1011PAA 7 PIN
-

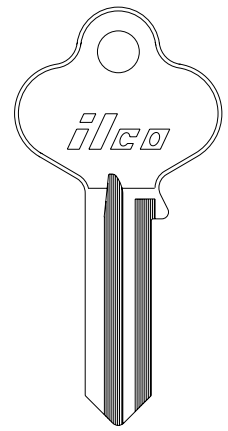

1011S
-

ILCO
EZ

RUSSWIN (now Corbin/Russwin)

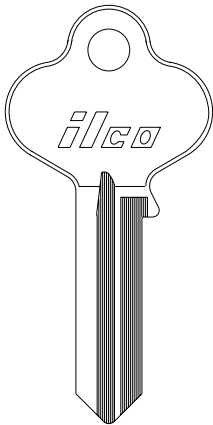

1011T
-

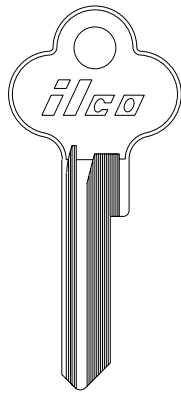

X1001KC
-

ILCO
EZ

NORTH AMERICAN CYLINDER

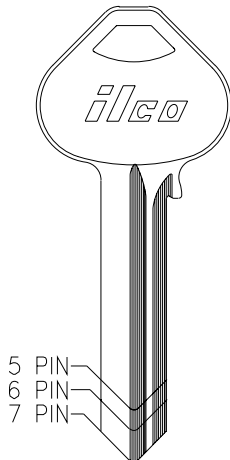
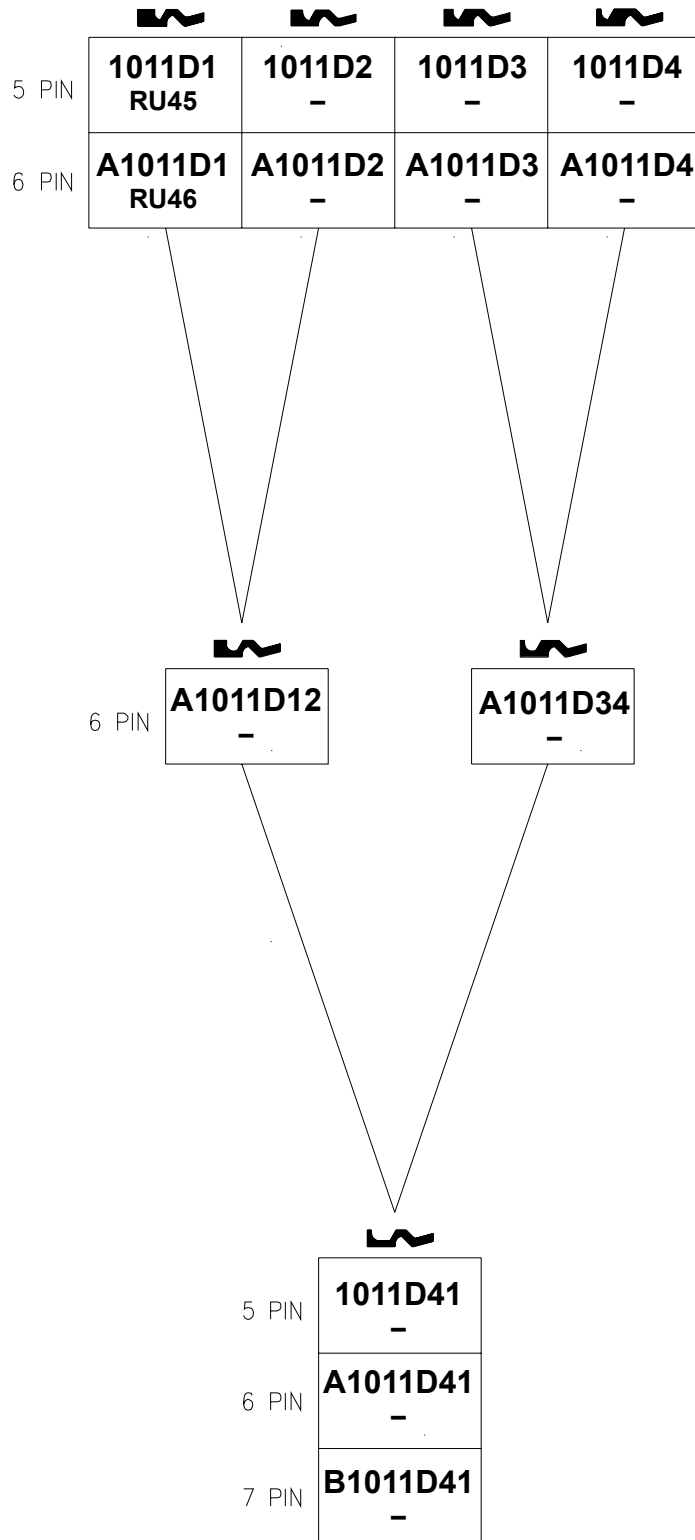

NORTH AMERICAN CYLINDER



NORTH AMERICAN CYLINDER

5 PIN	1011-L1 -	1011-L2 -	1011-L3 -	1011-L4 -
6 PIN	A1011-L1 -	A1011-L2 -	A1011-L3 -	A1011-L4 RU101
7 PIN				L1011-L4 -

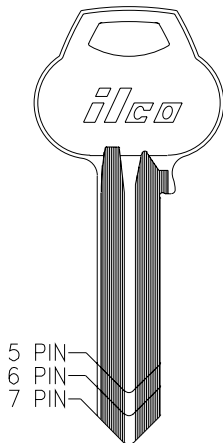

5 PIN	1011-L12 -	1011-L34 -
6 PIN	A1011-L12 -	A1011-L34 -

5 PIN	1011-L41 -
6 PIN	A1011-L41 -
7 PIN	L1011-L41 -

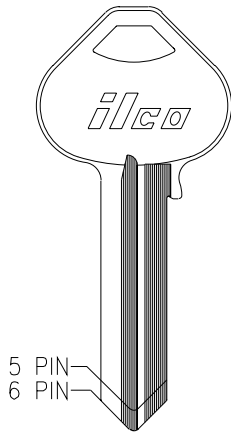

RUSSWIN (now Corbin/Russwin)







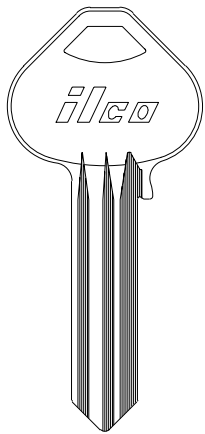

			
5 PIN	N1011P -	N1011S -	
6 PIN	A1011P -	A1011S -	A1011T -

	
5 PIN	N1011M -
6 PIN	A1011M -

**ILCO
EZ**

RUSSWIN (now Corbin/Russwin)



	A1011H1 -		A1011H6 -
	A1011H2 -		A1011H7 -
	A1011H3 -		A1011H8 -
	A1011H5 -		

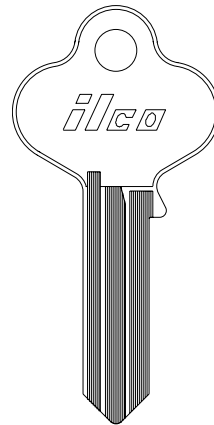







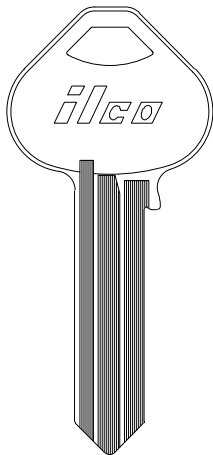









(MASTER)
1011PZ
-

**ILCO
EZ**

RUSSWIN (now Corbin/Russwin)



	A1011-1N -		A1011-5N -		A1011-9N -		A1011-13N -
	A1011-2N -		A1011-6N -		A1011-10N -		A1011-14N -
	A1011-3N -		A1011-7N -		A1011-11N -		
	(MASTER) A1011PZ -		A1011-4N -		A1011-8N -		A1011-12N -









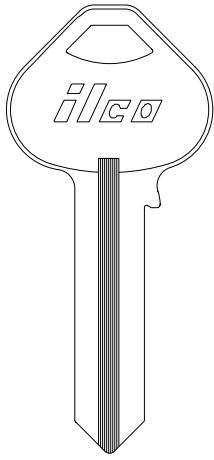



**ILCO
EZ**





RUSSWIN (now Corbin/Russwin)



- | | | | |
|--|---|--|--|
| 
A1011-15N
- | 
A1011-19N
- | 
A1011-23N
- | |
| 
A1011-16N
- | 
A1011-20N
- | 
A1011-24N
- | |
| 
A1011-17N
- | 
A1011-21N
- | 
A1011-25N
- | |
| 
(MASTER)
A1011PZR
- | 
A1011-18N
- | 
A1011-22N
- | 
A1011-26N
- |

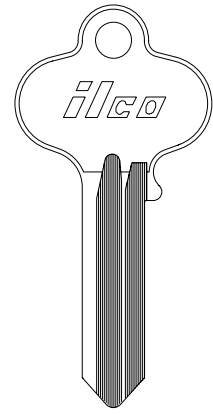

- | | |
|--|--------------------|
| 
1012
RU2 | ILCO
EZ |
|--|--------------------|

RUSSWIN

SAFE

SAGER

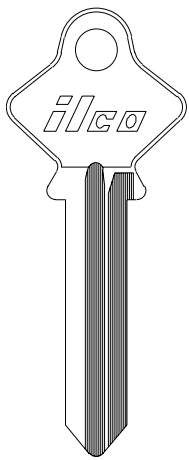

- | |
|---|
| 
1012A
- |
|---|

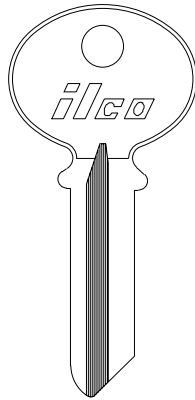

- | |
|---|
| 
1049D
- |
|---|

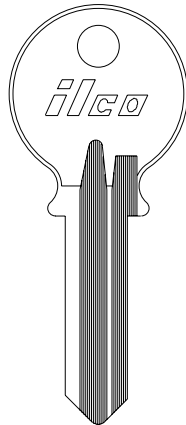

- | |
|---|
| 
1049E
- |
|---|

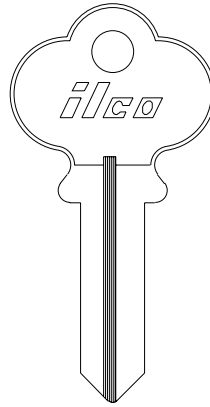

- | |
|--|
| 
1047
- |
|--|

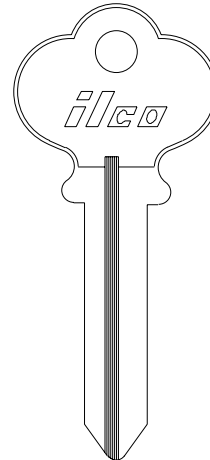

- | |
|---|
| 
1047A
- |
|---|

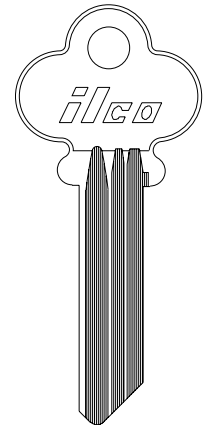

- | | |
|--|--------------------|
| 
1047CL
- | ILCO
EZ |
|--|--------------------|

SAGER

SARGENT * (Compatible)

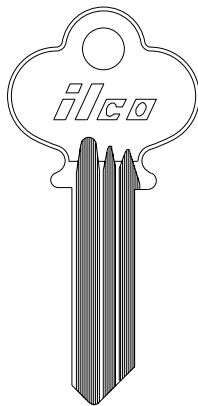

- | |
|--|
| 
1047CR
SA1 |
|--|

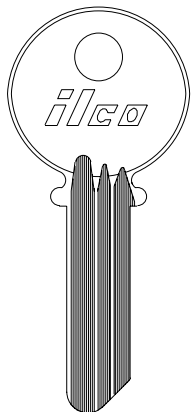

- | |
|---|
| 
1047M
- |
|---|

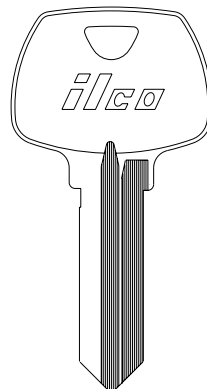

- | |
|--|
| 
1007
- |
|--|

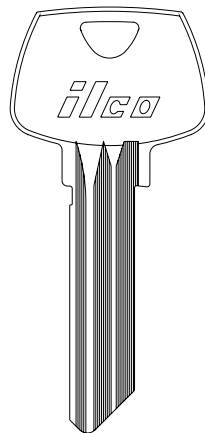

- | |
|---|
| 
O1007CR
- |
|---|

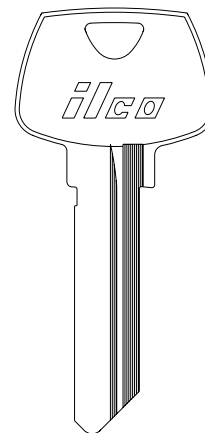

- | |
|---|
| 
O1007NB
- |
|---|

**ILCO
EZ**

NORTH AMERICAN CYLINDER

SEC
2
PG
264

*Sargent is a trademark of a third party not affiliated or linked with Kaba Ilco or the Dormakaba Group.





NORTH AMERICAN CYLINDER



5 PIN	1007CA S22 1/2	1007CB -		1007CE -	1007CF -	1007CG -			
6 PIN	O1007CA S22	O1007CB -		O1007CE -	O1007CF -	O1007CG -			
7 PIN				L1007CE -	L1007CF -	L1007CG -			

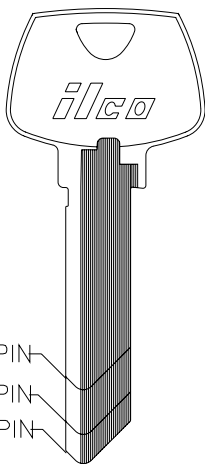
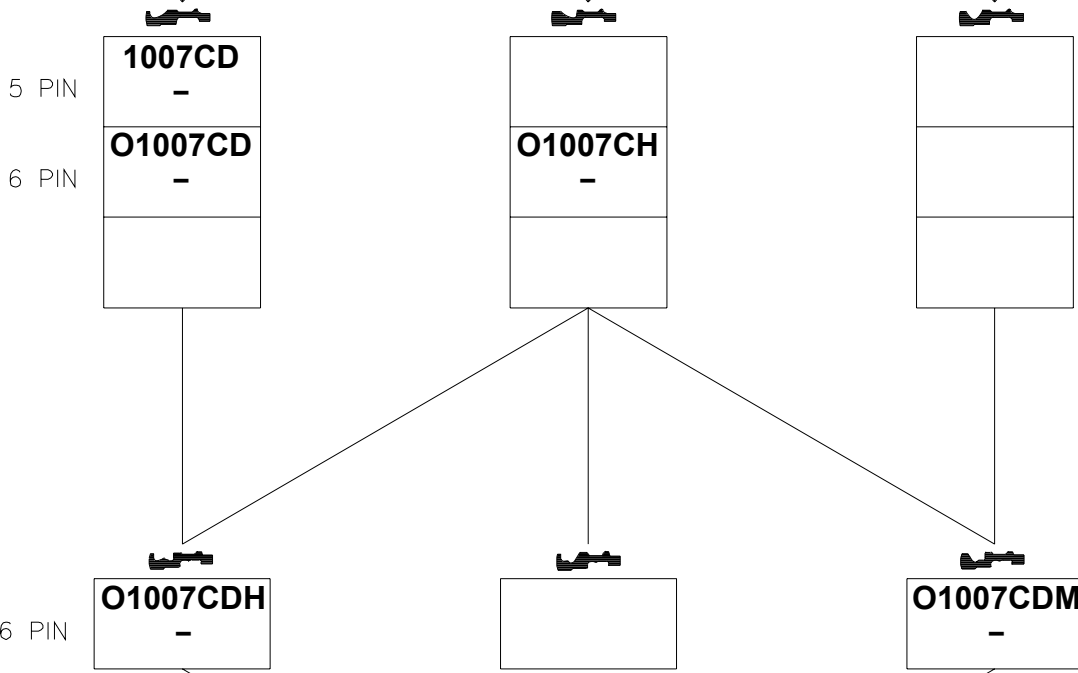

5 PIN	1007CN -
6 PIN	O1007CN -
7 PIN	L1007CN -



5 PIN	1007HA	1007HB	1007HC	1007HE	1007HF	1007HG	1007HJ	1007HL
	-	-	-	-	-	-	-	-
6 PIN	O1007HA	O1007HB	O1007HC	O1007HE	O1007HF	O1007HG	O1007HJ	O1007HL
	-	-	-	-	-	-	-	-

5 PIN	1007HD
	-
6 PIN	O1007HD
	-

5 PIN	1007HH
	-
6 PIN	O1007HH
	-

5 PIN	1007HM
	-
6 PIN	O1007HM
	-

5 PIN	1007HDH
	-
6 PIN	O1007HDH
	-

5 PIN	1007HN
	-
6 PIN	O1007HN
	-

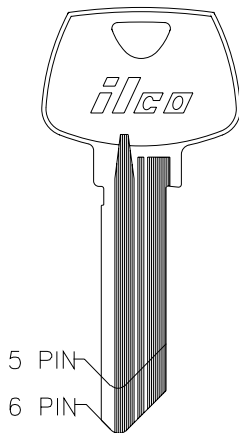



NORTH AMERICAN CYLINDER

	1007LA	1007LB	1007LC	1007LE	1007LF	1007LG	1007LJ	1007LK	1007LL
5 PIN	-	-	-	-	-	-	-	-	-
	O1007LA	O1007LB	O1007LC	O1007LE	O1007LF	O1007LG	O1007LJ	O1007LK	O1007LL
6 PIN	-	-	-	-	-	-	-	-	-
	L1007LA								L1007LL
7 PIN	-								-

	1007LD	1007LH	1007LM
5 PIN	-	-	-
	O1007LD	O1007LH	O1007LM
6 PIN	-	-	-
		L1007LH	L1007LM
7 PIN		-	-

	1007LDH	1007LDM	1007LHM
5 PIN	-	-	-
	O1007LDH	O1007LDM	O1007LHM
6 PIN	-	-	-

	N1007KMB
5 PIN	-
	N1007KMA
6 PIN	-
	N1007KMC
7 PIN	-

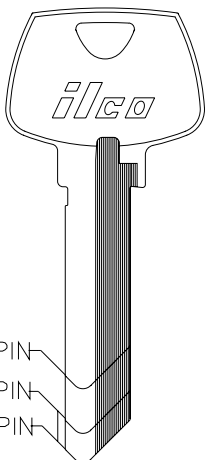



5 PIN	1007RA -	1007RB -	1007RC -	1007RE -	1007RF -	1007RG -	1007RJ -	1007RK -	1007RL -
6 PIN	O1007RA -	O1007RB -	O1007RC -	O1007RE -	O1007RF -	O1007RG -	O1007RJ -	O1007RK -	O1007RL -

5 PIN	1007RD -	1007RH -	1007RM -
6 PIN	O1007RD -	O1007RH -	O1007RM -

5 PIN	1007RDH -	1007RDM -	1007RHM -
6 PIN	O1007RDH -	O1007RDM -	O1007RHM -

5 PIN	N1007RMB -
6 PIN	N1007RMA -

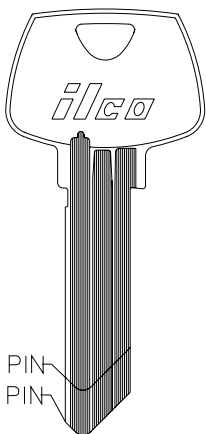

SARGENT * (Compatible)



NORTH AMERICAN CYLINDER

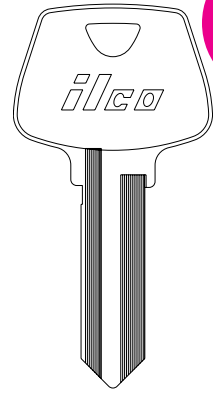
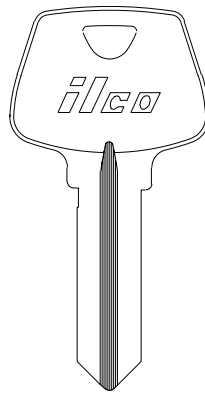
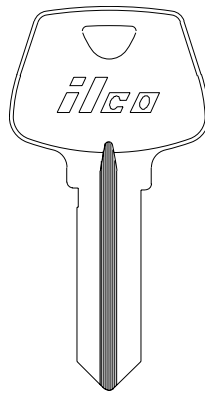
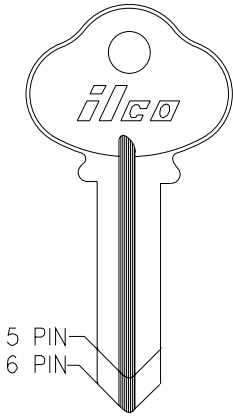
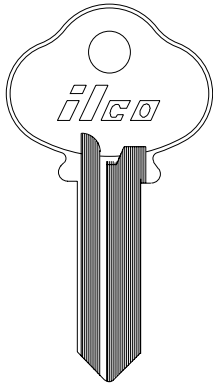

ILCO
EZ 1008
-

5 PIN 6 PIN
1009 1009A
S1 S5

1009M
-

O1009
S2

1010
S3

SARGENT * (Compatible)

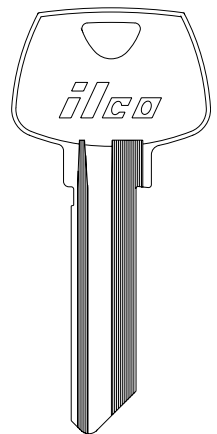
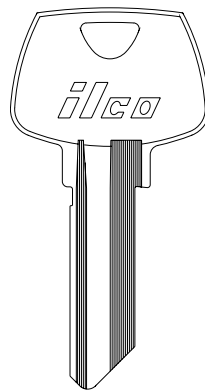
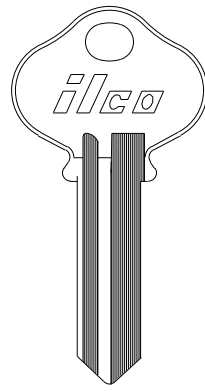
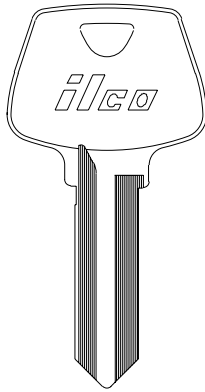
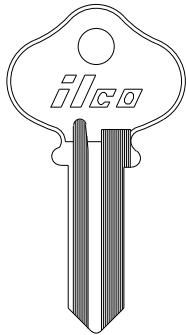
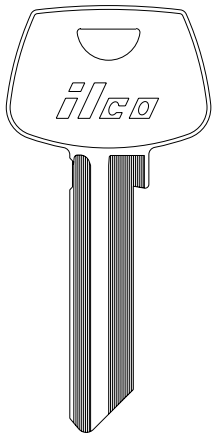

ILCO
EZ 1010A
-

1010B
S10

1010M
-

1010S
-

1010N
S68

L1010N
-

SARGENT * (Compatible)

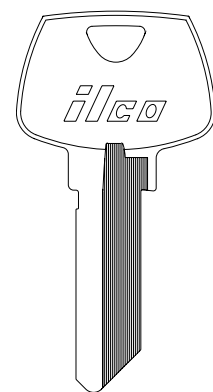
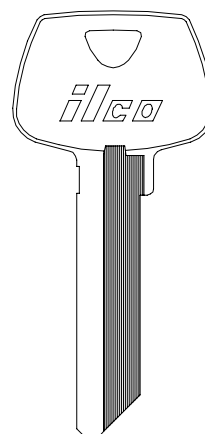
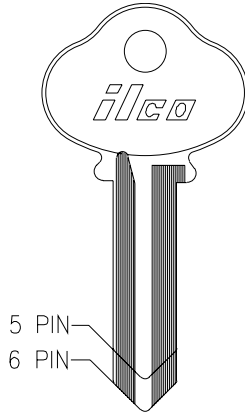
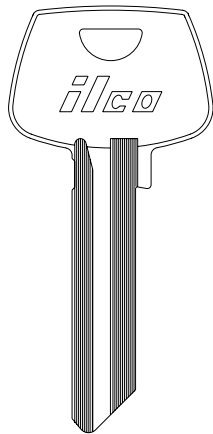
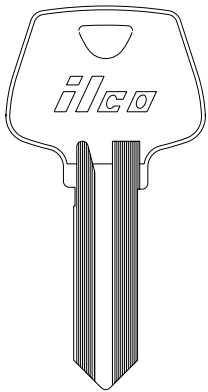

ILCO
EZ 1010U
-

A1010U
-

5 PIN 6 PIN
O1010 O1010A
-

S6
-

S16
-



*Sargent is a trademark of a third party not affiliated or linked with Kaba Ilco or the Dormakaba Group.



SARGENT * (Compatible)

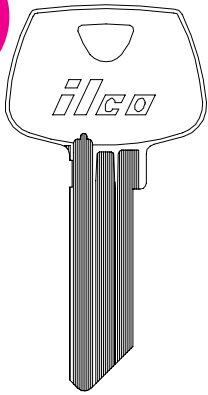

S32
-

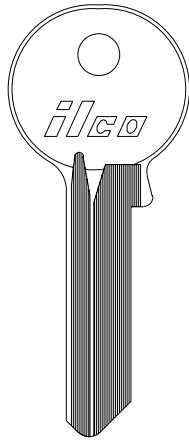

O1054A
-

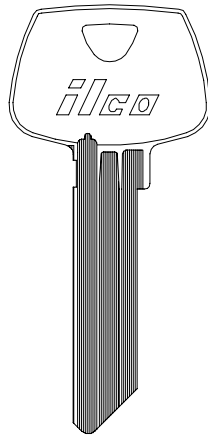

S31
-

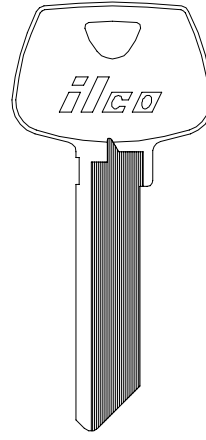

S70
-

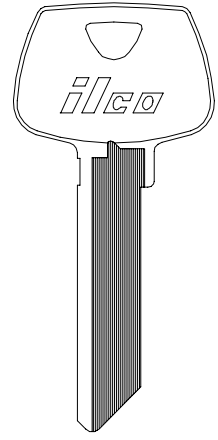

S73
-

ILCO
EZ

SCHLAGE

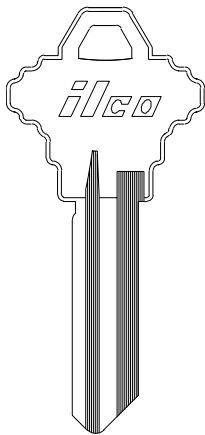

SC1246
-



SC1247
-



SC1248
-



SC1345
-



SC1347
-



SC1340
-



SC1368
-



SC1400
-



SC1456
-



SC1460
-



SC1467
-



SC1468
-

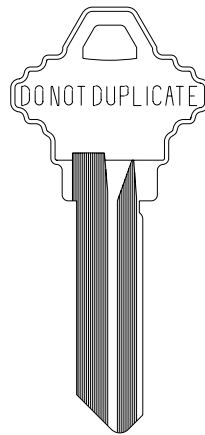

101C-NS-DND
-

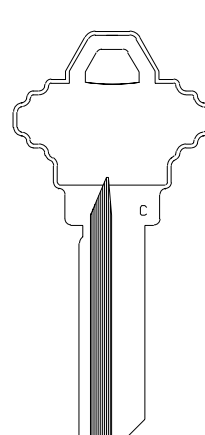

101C-NS-DND
-

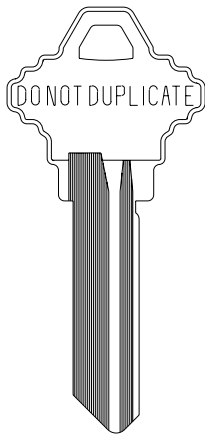

101E-NS-DND
-

ILCO
EZ

SCHLAGE

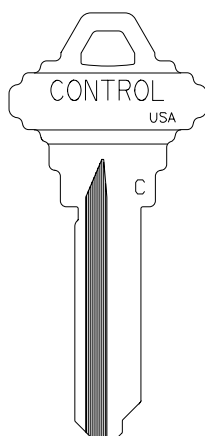

101-C LFIC
CONTROL

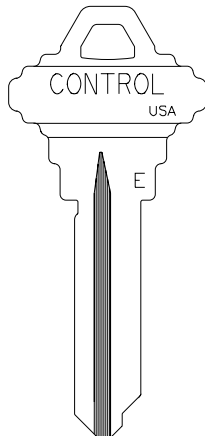

101-E LFIC
CONTROL

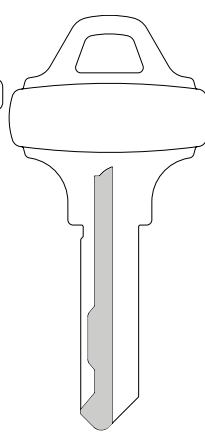

C123
-

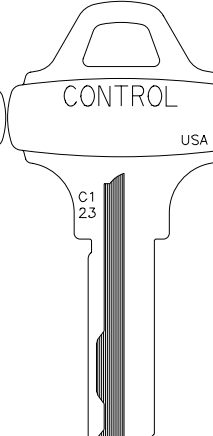

C123
CONTROL

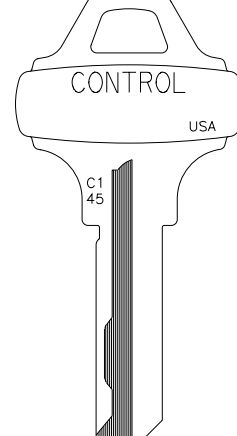

C145
CONTROL

ILCO
EZ

NORTH AMERICAN CYLINDER

SEC 2
PG 270

*Sargent is a trademark of a third party not affiliated or linked with Kaba Ilco or the Dormakaba Group.



SCHLAGE

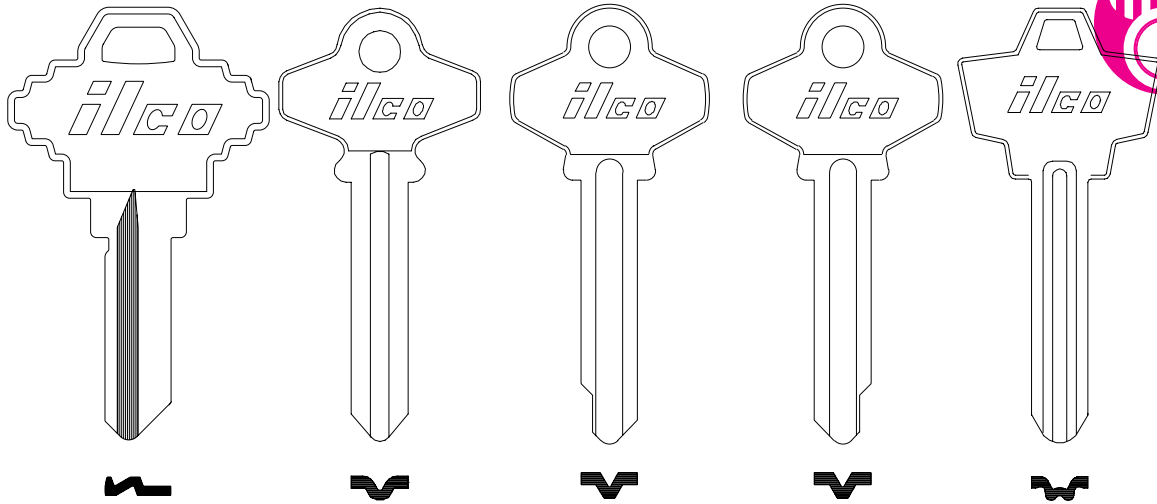

ILCO
EZ

SC1-BIG
-

1307A
SC6

L1307A
-

R1307A
-

1307W
SC22

SCHLAGE

5 PIN	1145 SC1	1145CE -	1145E SC8	1145EF -	1145F SC7	1145FG -	1145G -
6 PIN	1145A SC4	A1145CE -	A1145E SC9	A1145EF -	A1145F SC10	A1145FG -	A1145G -

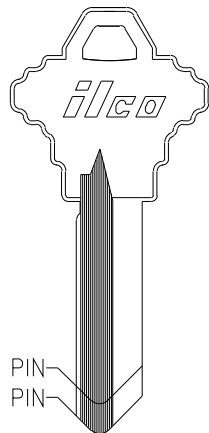

5 PIN	1145H -
6 PIN	A1145H SC15

5 PIN	1145J -
6 PIN	A1145J -

5 PIN	1145K -
6 PIN	A1145K -

5 PIN	1145L SC19
6 PIN	A1145L SC20

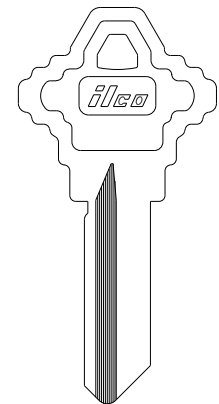

SC1-PC
-

ILCO
EZ





SCHLAGE

SCHROEDER

SCHROEDER THOMPSON SECURITY

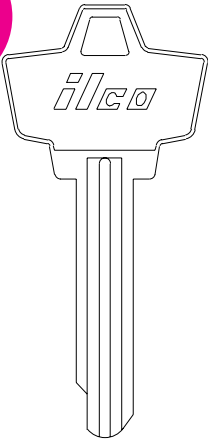

L1307W

-

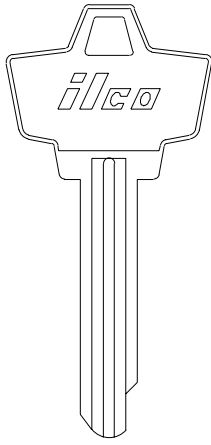

R1307W

-

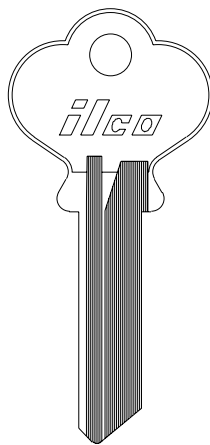

1126M

-

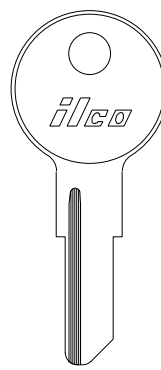

759ST

-

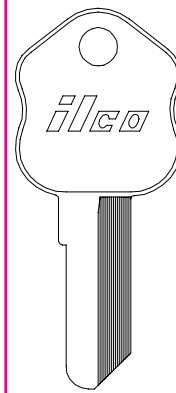

SY9

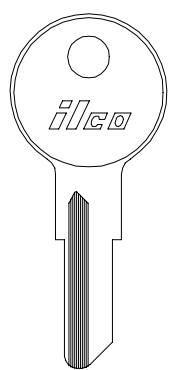

O1122B
Y103

ILCO
EZ

SECURITY MAILBOX SEGAL

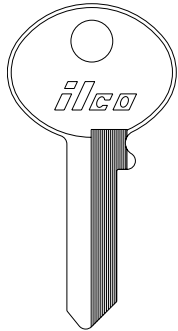

1559

-

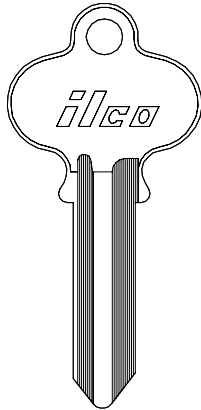

1022
SE1

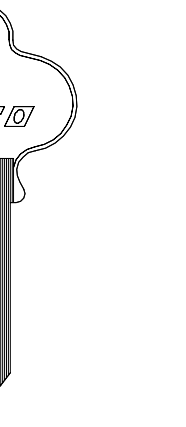

O1022

-

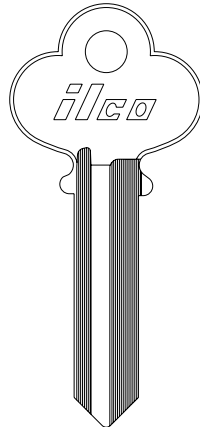

1022AB

-



O1122B

-

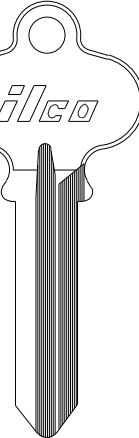

1022H

-

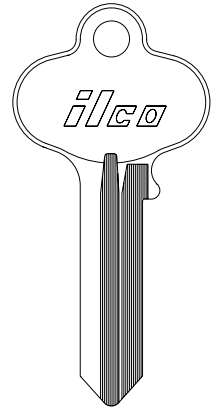

1022L

-

ILCO
EZ

SENTRY SAFES

SHAW WALKER

SKILLMAN

SKYTRAK

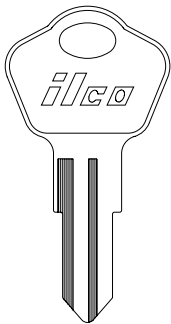

1626
SS4

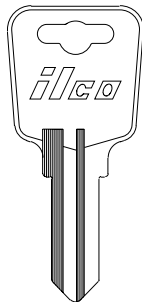

1637
SS5

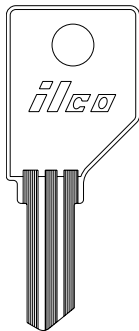

1534

-

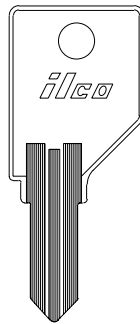

1568

-

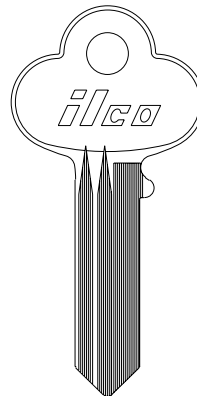

R1001EN
SK1

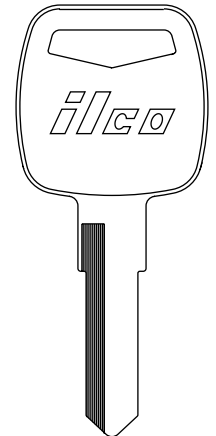

1642

-

ILCO
EZ

NORTH AMERICAN CYLINDER



SLAYMAKER

SOUTHERN IMPERIAL

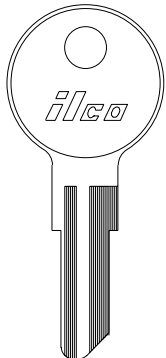
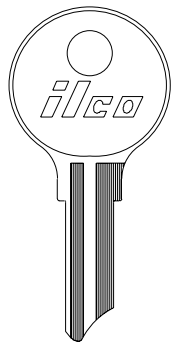

1120F
-

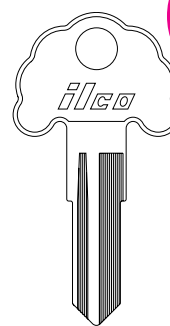
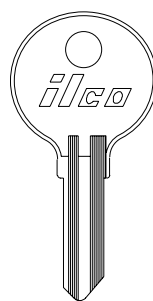
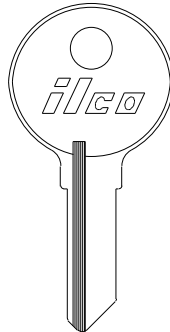

1120H
-

ILCO
EZ 1120K
-

1120D
SL1

1120J
-

1120S
-

1624
-

SUN

STANLEY PADLOCK TAYLOR

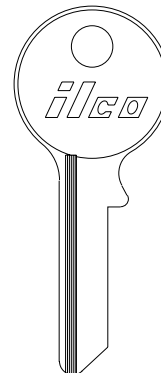
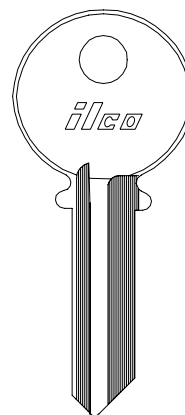
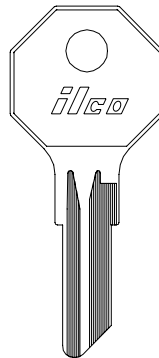
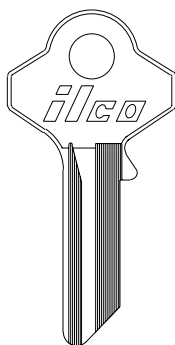
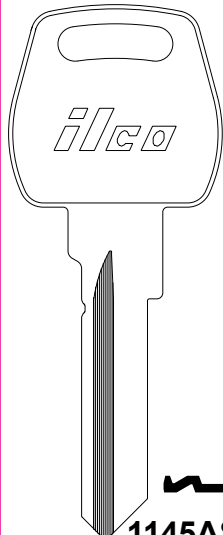
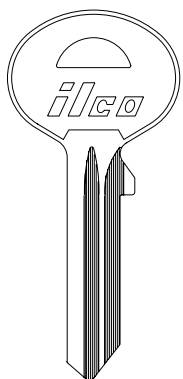

ILCO
EZ 1636
-

1145AST
ST4

TY1
-

H1122M
T2

1141
T1

1141E
-

1141F
T3

TAYLOR

THERMOSTAT BOX

TIMBERLINE

TITAN/KWIKSET

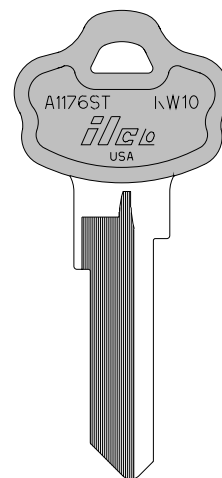
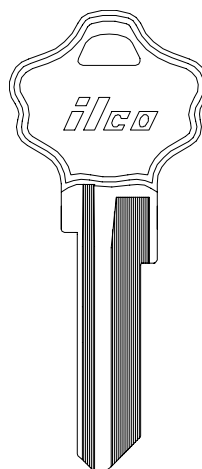
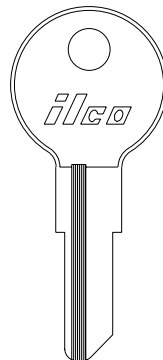
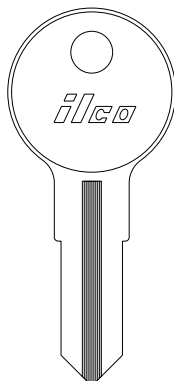
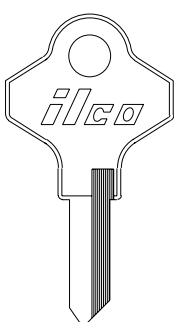
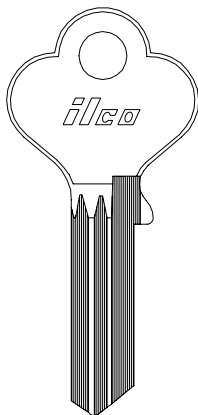

ILCO
EZ 1141GE
T7

1141K
-

1541
-

1043J
IL11

A1176ST
KW10

KW10-PC
-



NORTH AMERICAN CYLINDER



TRIMARK

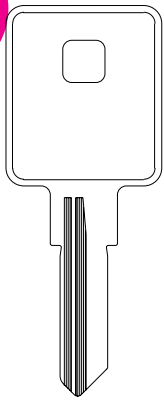

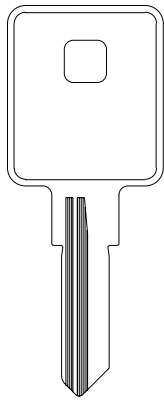

1601
TM1



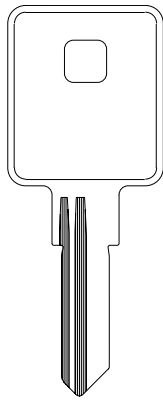

1602
TM2

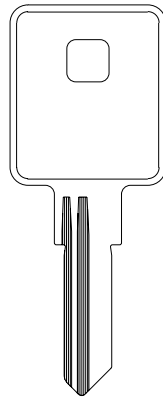



1603
TM3

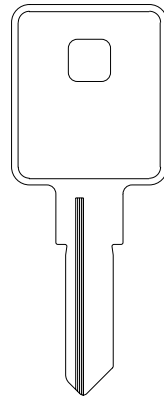

1604
TM4



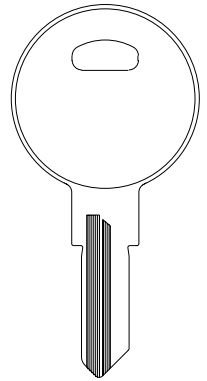

1606
TM6



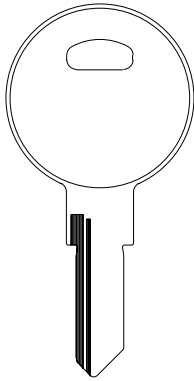

1607
TM7

ILCO
EZ

TRIMARK



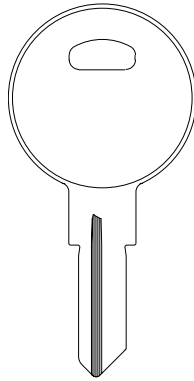

1608
TM8



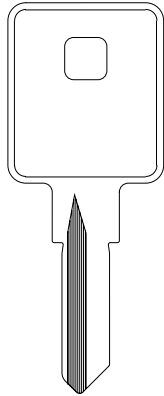

1609
TM9

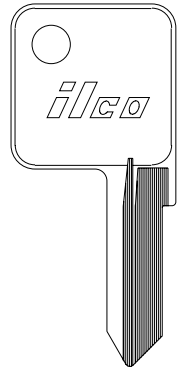



1610
TM10

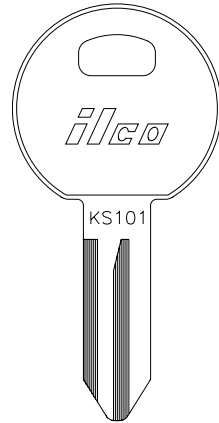

1612
TM12



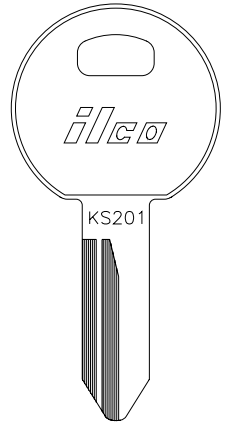

1621
TM13



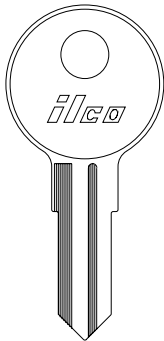

1622
TM14

ILCO
EZ

TRIMARK



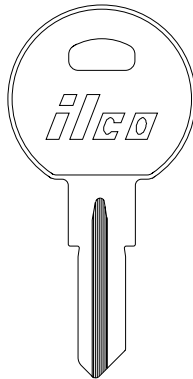

1623
TM15



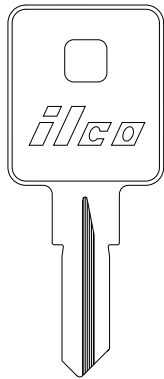

1650
TM16

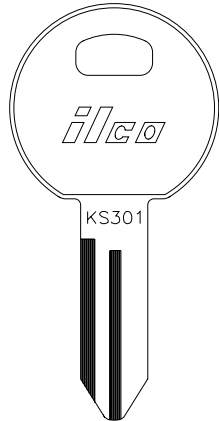



1651
TM17

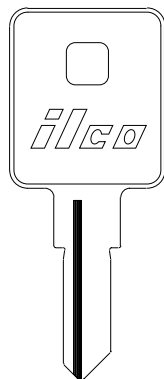

1665
TM18

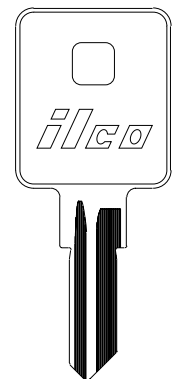

1666
TM19



1667
TM20

ILCO
EZ

NORTH AMERICAN CYLINDER



TRU GUARD



ILCO EZ
TG20
-

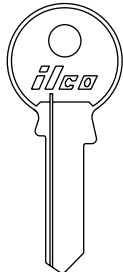

ILCO EZ
TG40
-

UNICAN

SEE
ILCO

USPS

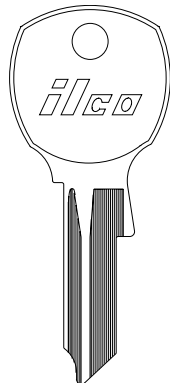

1646
-

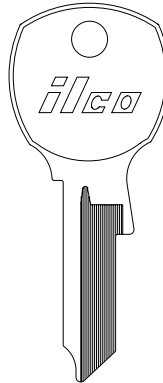

1646R
-

VIMCAR



SEE
OLYMPIC

WEISER

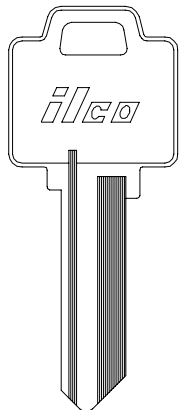

ILCO EZ
N1054WB
WR5

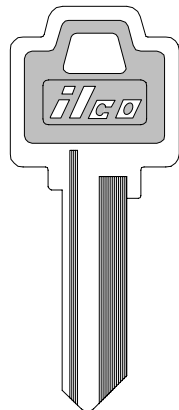

WR5-PC
-

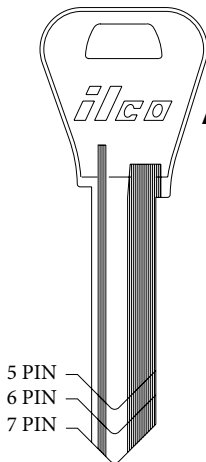

5 PIN
6 PIN
7 PIN
1054WB
WR3

6 PIN
A1054WB
WR4
7 PIN
L1054WB
-

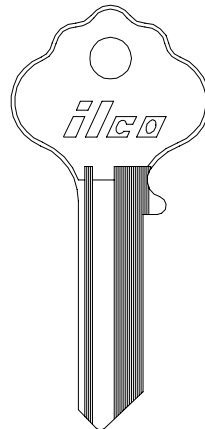

X1054WA
WR2

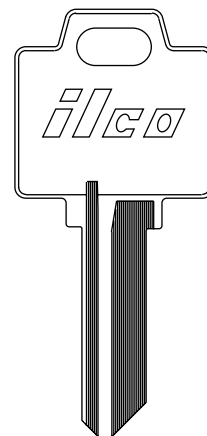

N1176
WR6

NORTH AMERICAN CYLINDER

WELCH

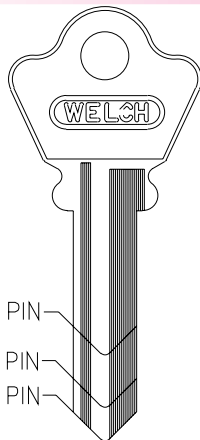

ILCO EZ
1123S
-

5 PIN
1123
-
6 PIN
1123A
-

WESLOCK

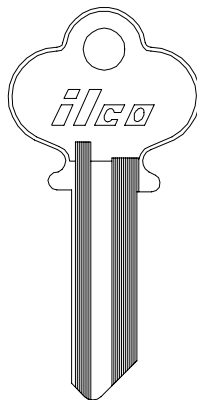

1175
WK1

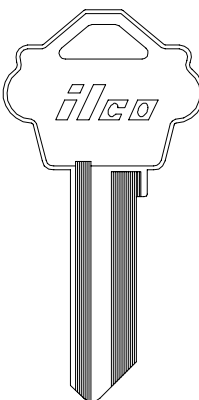

1175N
WK2



WK2-PC
-

WILSON-BOHANNON

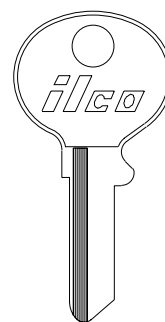

WB19
-





WILSON-BOHANNON

WIND

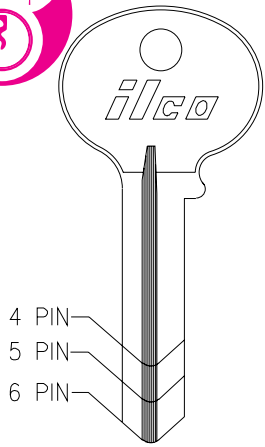

5 PIN
1071

6 PIN
1071A

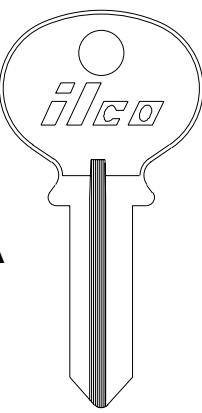

1071AB

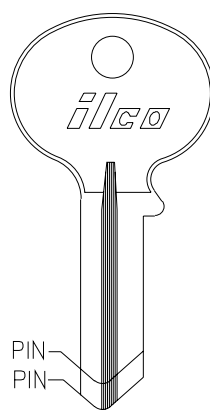

4 PIN
5 PIN

4 PIN 5 PIN
1071BD 1071D

1071BE 1071E

1071BM 1071M

4 PIN
1071B

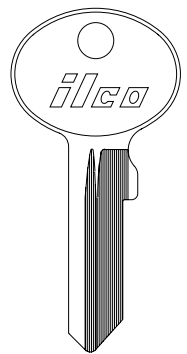

1634 WN1 ILCO EZ

NORTH AMERICAN CYLINDER

WIND

WOOD/TREADWAY

WRIGHT PRODUCTS

XL LOCK

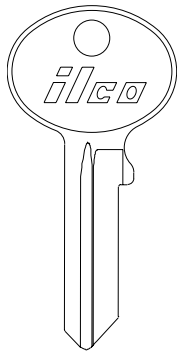

1686 WN2

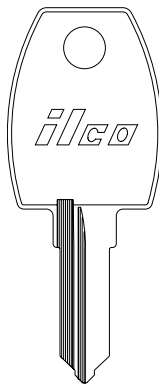

1674

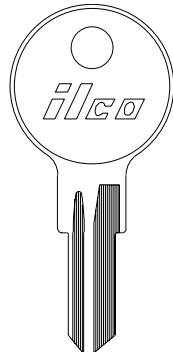

1616 WTP1

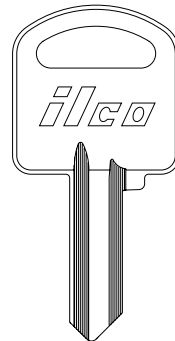

1662 WTP2

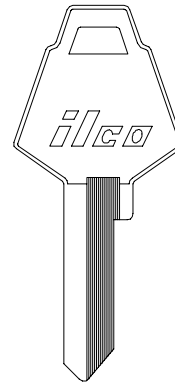

1180S XL7

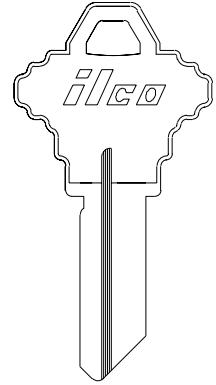

1182 ILCO EZ

YALE * (Compatible)

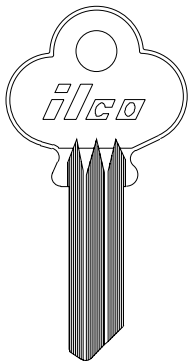

Y8

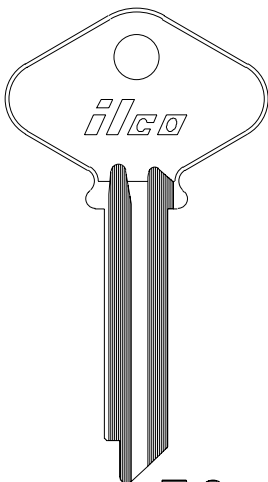

D9

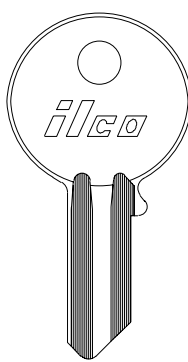

SX9B

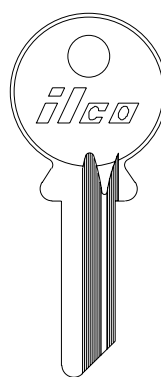

Y204

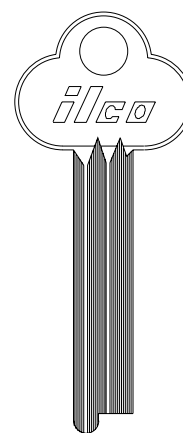

889A

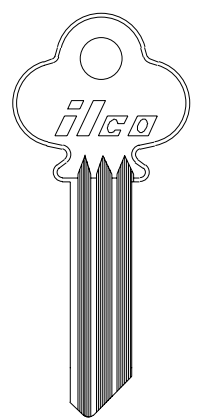

994ARM ILCO EZ



YALE * (Compatible)

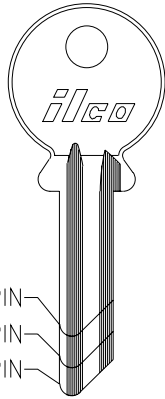
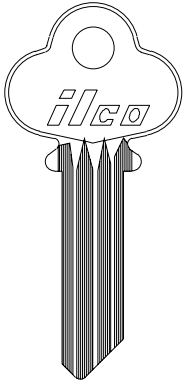

5 PIN
Y200

-

6 PIN
997A

-

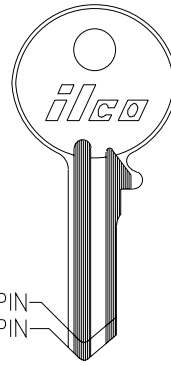

4 PIN
5 PIN

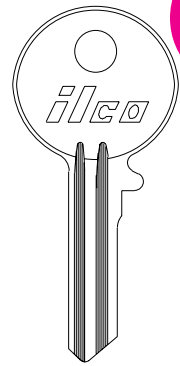

ILCO
EZ

994M

-

4 PIN
997B

-

4 PIN
997DB

-

5 PIN
997D

-

997DA

-

R997DA

-

YALE * (Compatible)

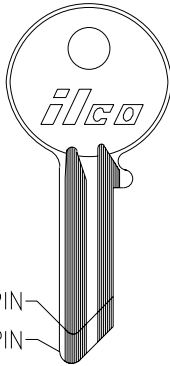

4 PIN
5 PIN

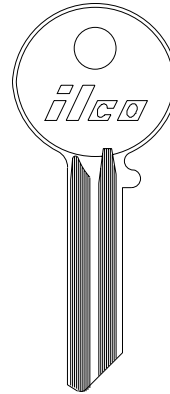
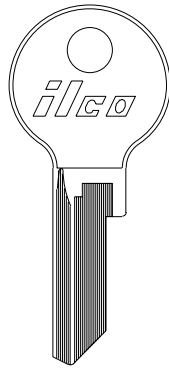
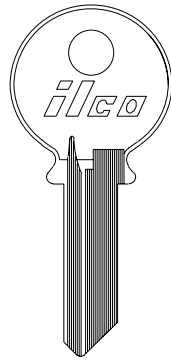

997JB

-

997JF

-

997JC

-

997JD

-

ILCO
EZ

4 PIN
997EB
Y5

5 PIN
997E
Y52

997G

-

997GR

-

997GX

-

997JA

-

997JE

-

YALE * (Compatible)

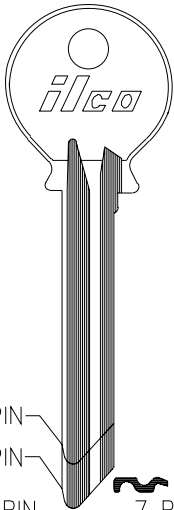

6 PIN
7 PIN

6 PIN
997L

7 PIN
997LA

-

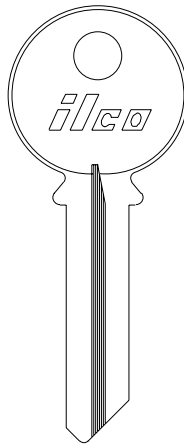

997PA

-

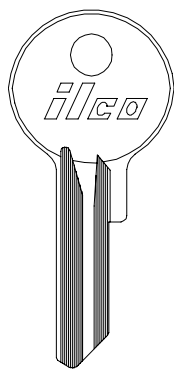

997X
Y6

4 PIN
5 PIN

4 PIN
H997EB

-

5 PIN
H997E

-

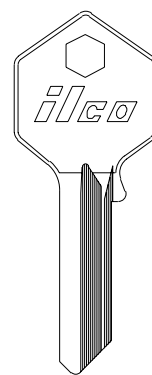

H997ER

-

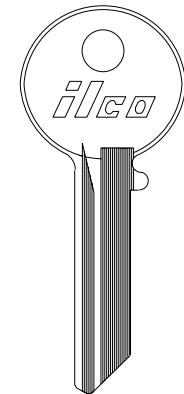

J997M

-

J997MR

-

ILCO
EZ



*Yale is a trademark of a third party not affiliated or linked with Kaba Ilco or the Dormakaba Group.



YALE * (Compatible)

NORTH AMERICAN CYLINDER

6 PIN	998VA -	998VB -	998VC -	998VD -	998VE -	998VF -	998VG

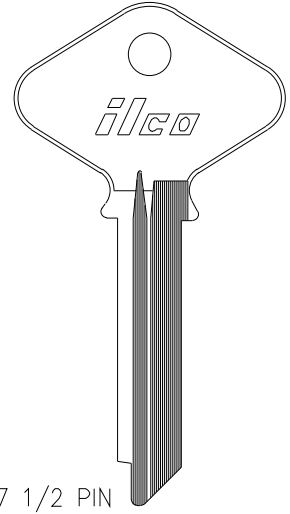
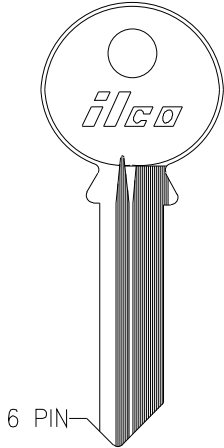

6 PIN		998R -
7 1/2 PIN		H998R -

6 PIN	998YA -	998YB -	998YC -	998YD -	998YE -		998YG -	998YH -

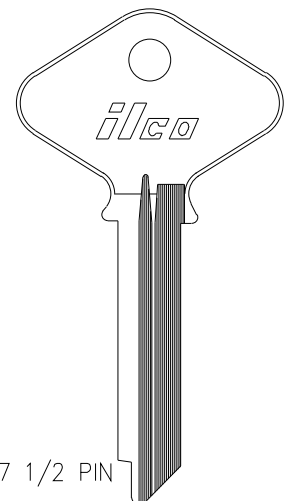
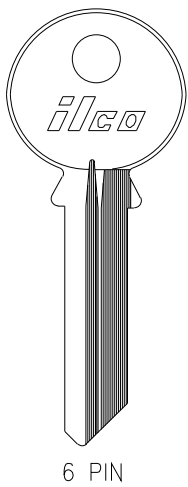

6 PIN		998YMK -
7 1/2 PIN		H998YMK -

YALE * (Compatible)

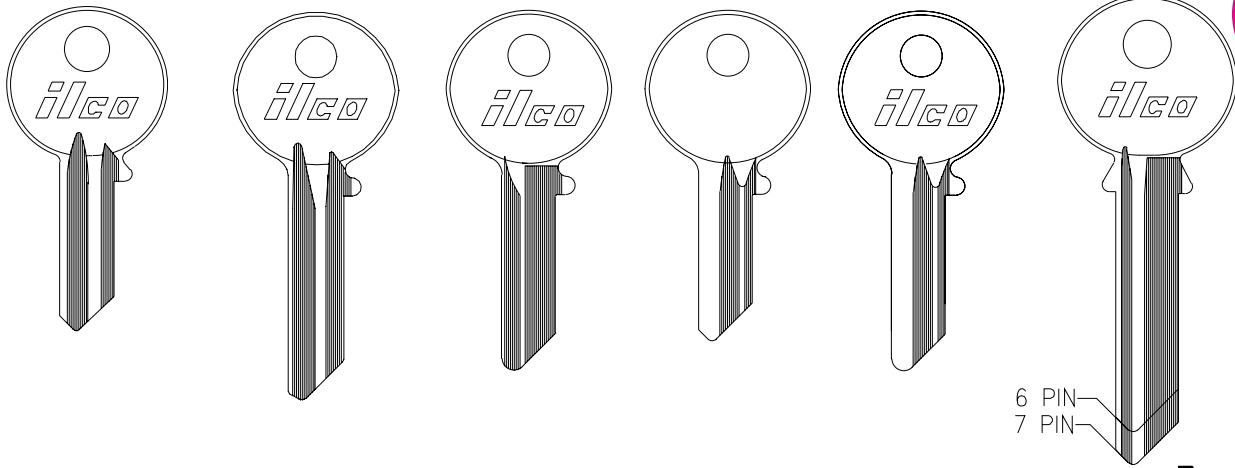

ILCO	B997EH	O997E	O997ER	O997G	R997EB	997ER	998GST	A998GST
EZ	-	Y54	-	-	-	-	-	-

6 PIN
7 PIN

6 PIN 7 PIN

YALE * (Compatible)

6 PIN	998LA	998LB	998LC	998LD	998LE	998LF	998LG
	-	-	-	-	-	-	-

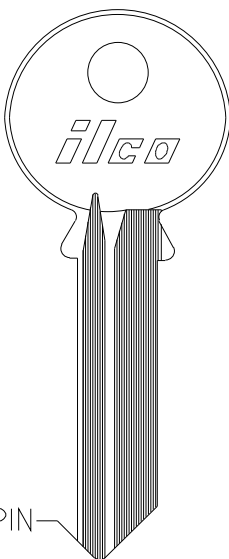

6 PIN

6 PIN

998GL

NORTH AMERICAN CYLINDER



YALE * (Compatible)

NORTH AMERICAN CYLINDER

6 PIN	998SA -	998SB -	998SC -	998SD -	998SE -	998SF -	998SG -	998SH -
7 1/2 PIN	H998SA -	H998SB -		H998SD -	H98SE -		H998SG -	

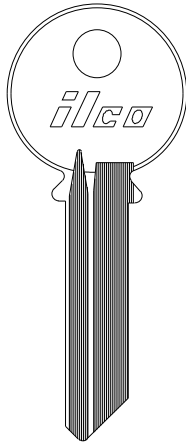

6 PIN

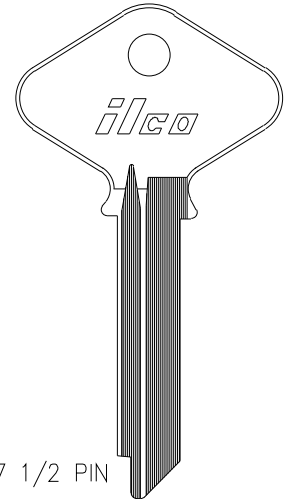

7 1/2 PIN

6 PIN	998SMK -
7 1/2 PIN	H998SMK -

6 PIN	998TA -	998TB -		998TD -	998TE -	998TF -	998TG -	998TH -
7 1/2 PIN	H998TA -	H998TB -			H998TE -			

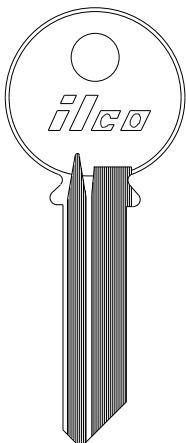

6 PIN

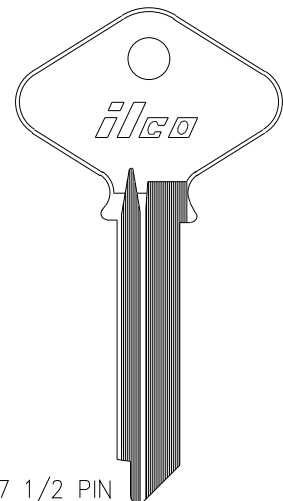

7 1/2 PIN

6 PIN	998TMK -
7 1/2 PIN	H998TMK -

SEC 2
PG 280











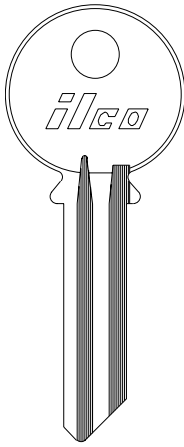
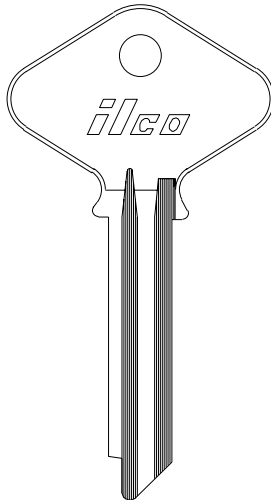
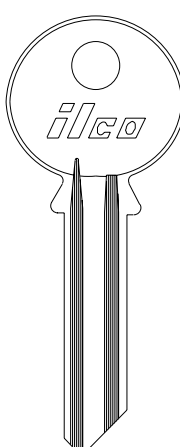













*Yale is a trademark of a third party not affiliated or linked with Kaba Ilco or the Dormakaba Group.

ILCO
EZ









YALE * (Compatible)

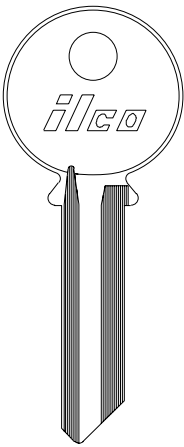
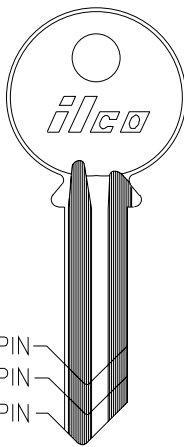
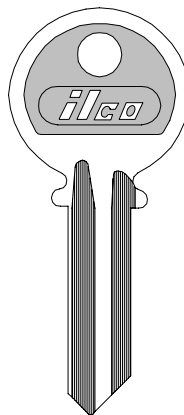
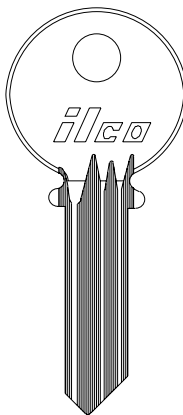
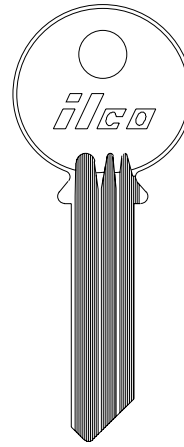





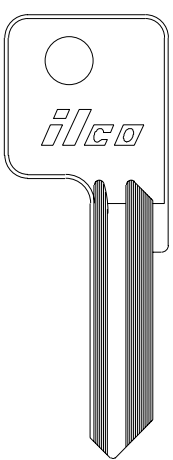
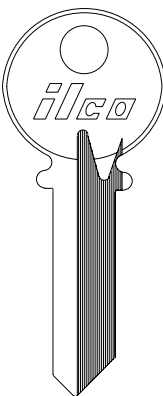
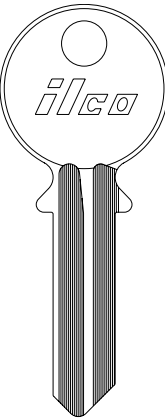
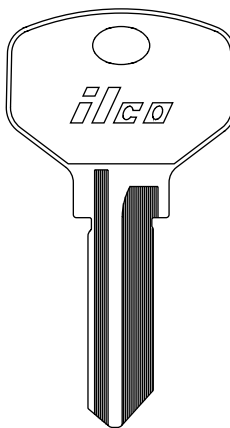
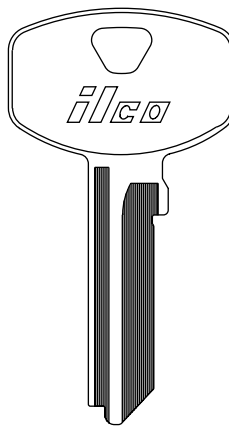

 <p>ILCO EZ</p>	 <p>7 1/2 PIN</p>	6 PIN	7 1/2 PIN	 <p>998PA</p>	 <p>998PB</p>	 <p>998PF</p>		
								
		998ZA	H998ZA				998ZB	H998ZB
								
		998ZC		998PD		998PH		
								
		998ZD		998PE				
								

YALE * (Compatible)

 <p>ILCO EZ</p>	 <p>4 PIN 5 PIN 6 PIN</p>	5 PIN	 <p>Y1-PC</p>	 <p>999CA</p>	 <p>Y202</p>
		6 PIN			
					
998SV	999B				
-	Y220				

YALE * (Compatible)

 <p>ILCO EZ</p>	 <p>999R</p>	 <p>999U</p>	 <p>999K1</p>	 <p>999K2</p>
				
Y1E	-	-	Y221	Y222

NORTH AMERICAN CYLINDER



*Yale is a trademark of a third party not affiliated or linked with Kaba Ilco or the Dormakaba Group.



YALE * (Compatible)

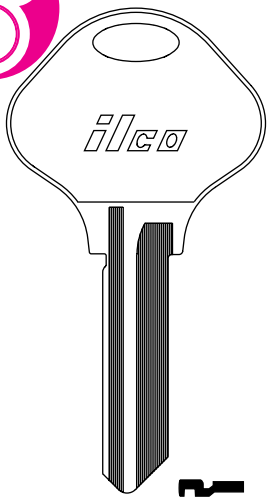

999K3
Y223

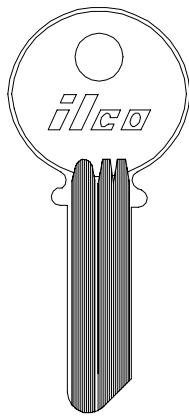

C999
Y3

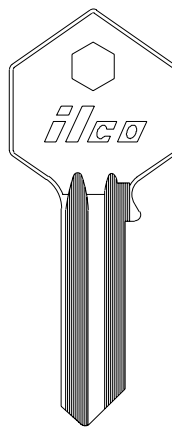

H999
-

H999R
-

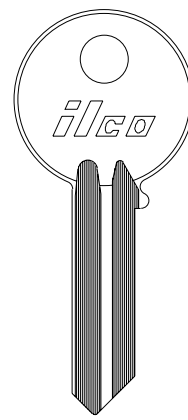

X999
-

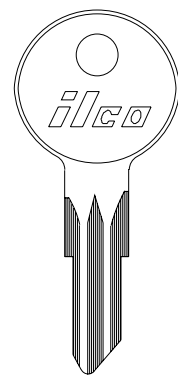

1122D
-

ILCO
EZ

YALE * (Compatible)

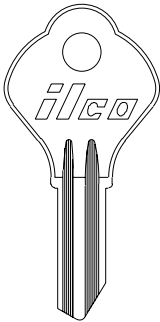

F1122A
-

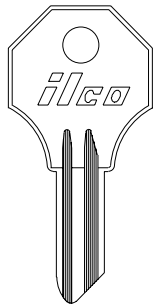

F1122AR
-

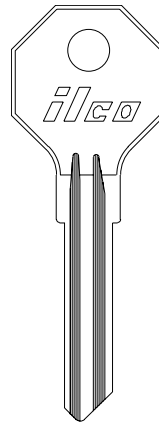

H1122F
-

H1122FR
-

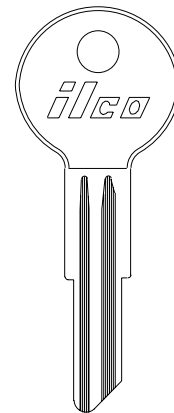

H1122W
-

L1122A
Y101

L1122AR
-

ILCO
EZ

YALE * (Compatible)

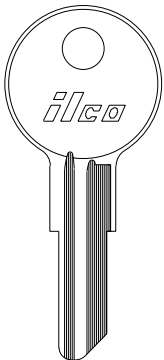

O1122
Y11

O1122A
-

O1122B
-

O1122BE
-

O1122AR
-

O1122BR
-

O1122BER
-

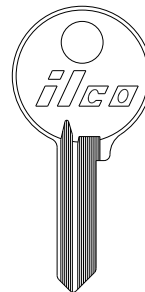

1132
-

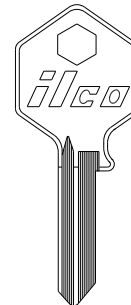

H1132
-

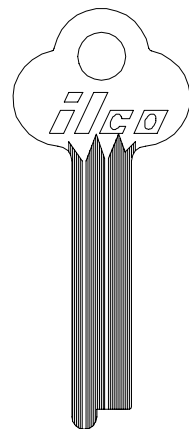

1587
-

ILCO
EZ

NORTH AMERICAN CYLINDER

SEC 2
PG 282

*Yale is a trademark of a third party not affiliated or linked with Kaba Ilco or the Dormakaba Group.





SECTION 3 INTERNATIONAL CYLINDER

Key Blanks designed for locks used primarily outside of North America. Manufacturers are listed in alphabetical order and keys are listed by manufacturer in a numerical order where possible.

Throughout this section you will notice  This symbol indicates that a special key machine is required to cut that blank.



ABLOY ABUS

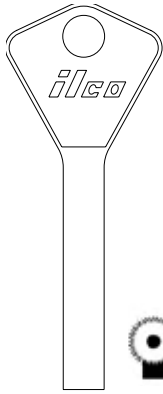

(BLACK)
AL1-BLK
AY1P
S11ABYP

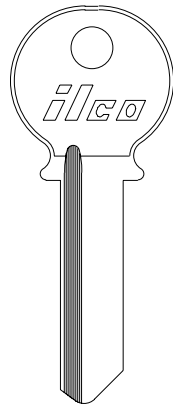

AB3
-
-

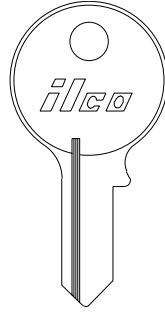

AB4
-
-

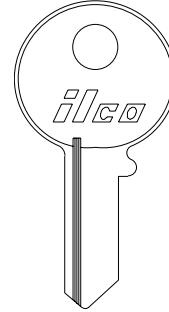

AB10
-
-

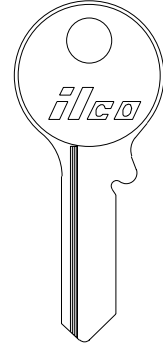

AB11
-
-

AB12
AB17R
ABS14L

ILCO
SILCA
ORION

ABUS

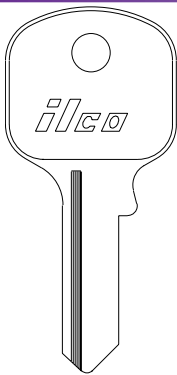

AB13
-
-

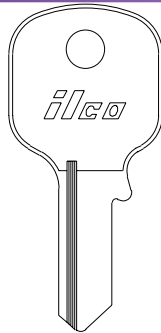

AB14
-
-

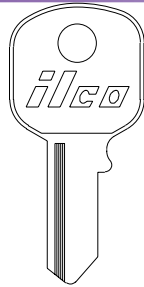

AB15
AB16R
-

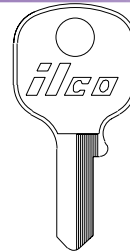

AB16
AB15R
-

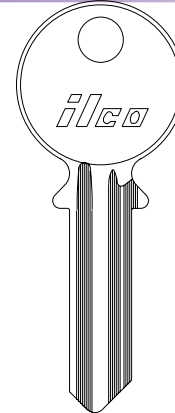

AB17
CS23
ABS20

AB19
AB8
ABS11

AB20
AB8R
ABS11L

AB21
AB10R
ABS12L

ILCO
SILCA
ORION

ABUS

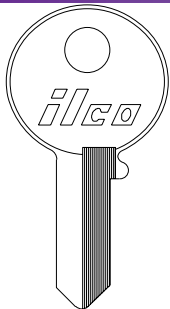

AB22
-
-

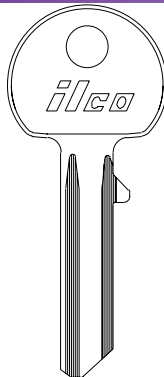

AB23
AB19
-



AB62CR
-
-

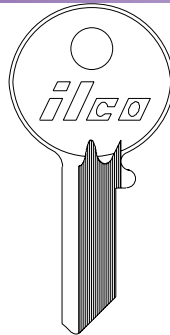

AB62C
CS6
-

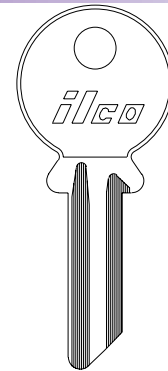

AB62E
CS7
CSA5P

AB62ER
CS7R
CSA5PL

ILCO
SILCA
ORION

INTERNATIONAL CYLINDER

ABUS

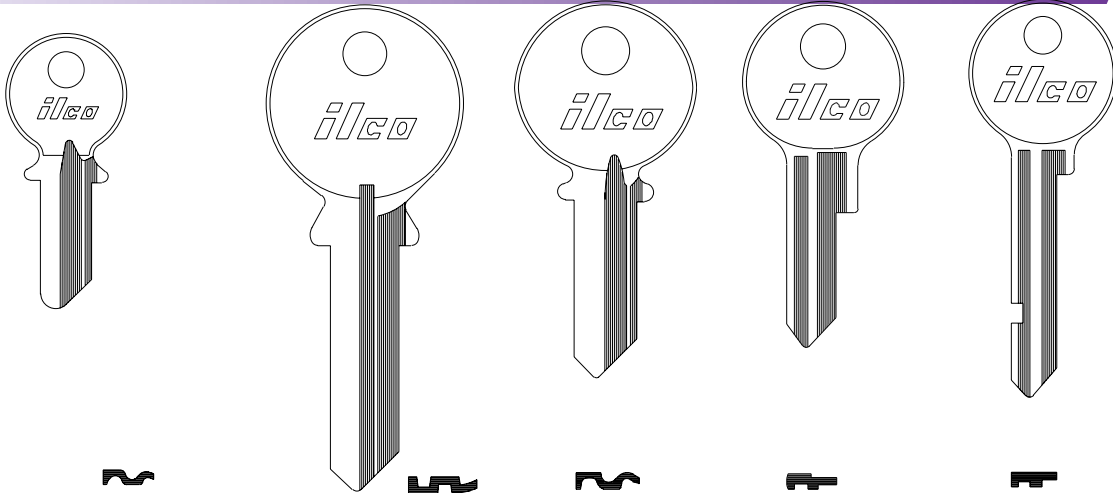

						
ILCO	AB62G	AB62GR	AB1	999B	AG1	AG2
SILCA	CS9	CCS9R	CS501	YA6	AG2R	AG1R
ORION	-	-	CSA51	YAL4	-	-

ALPHA

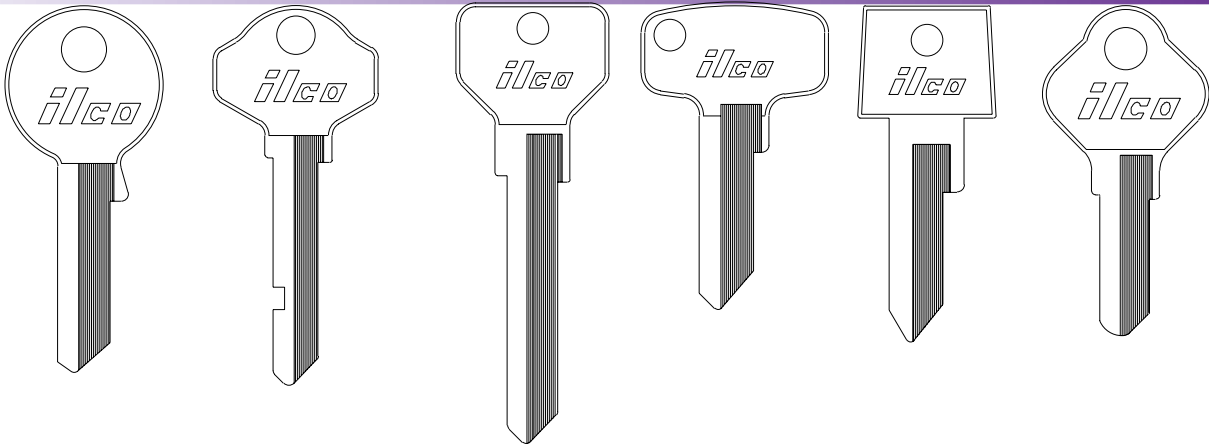

						
ILCO	ALP3	ALP6	ALP7	ALP9	ALP10	A190
SILCA	ALP7R	-	AD2	OLT1	AP10	ALP5R
ORION	-	-	-	-	-	-

ALPHA

ALPHA ALARM

ANKER

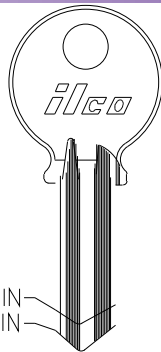
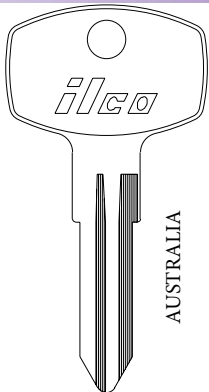
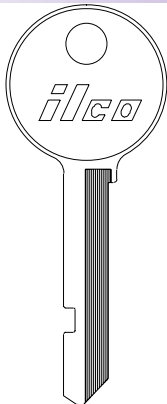

4 PIN
AK2
AKR2
ANK11

ILCO	A192
SILCA	-
ORION	-

AP6
-
-







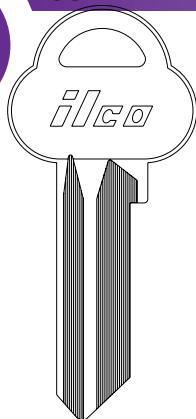

AK1
AKR1
ANK10





ASSA







- | | | | |
|--|---|--|--|
|  AS5
ASS33
A28K |  AS7
ASS33R
A28L |  61W
ASS2
A28N |  R61W
ASS2R
A28P |
|  AS23
ASS10
A28S |  AS25
ASS10R
A28R | | |
|  61Q
ASS31
A28E |  R61Q
ASS31R
A28F | | |

- | | | |
|---|--|---|
|  AS1
ASS11
A28G |  AS3
ASS11R
A28M |  61T
-
A28A |
|---|--|---|

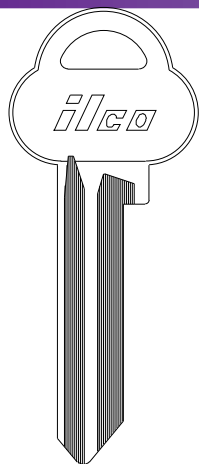
ILCO
SILCA
ORION

ASSA



- | | | | |
|--|--|--|--|
|  AS6
ASS32
A34K |  AS8
ASS17R
A34L |  A61W
ASS38
A34N |  AR61W
ASS38R
A34P |
|  A61Q
ASS40
A34E |  AR61Q
ASS40R
A34F | | |

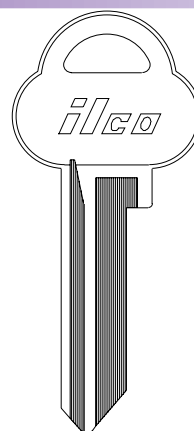

- | | |
|---|--|
|  AS1
ASS11
A28G |  AS3
ASS11R
A28M |
|---|--|



- | |
|--|
|  AS9
ASS13R
A29T |
|--|

ILCO
SILCA
ORION

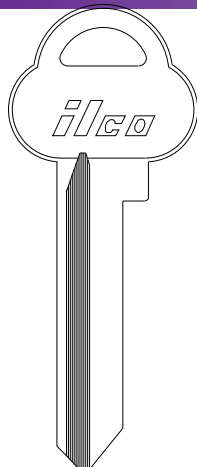
ASSA



- | |
|---|
|  AS32
ASS36R
A35X |
|---|

- | | |
|---|--|
|  AS10
ASS15R
A35T |  AS12
ASS34R
A35VM |
|---|--|

ILCO
SILCA
ORION









INTERNATIONAL CYLINDER

SEC

PG 286





									
5 PIN	AS19 ASS15 A29AK	AS15 ASS13 A29AL							AS51 ASS29 A29DM
6 PIN	AS20 ASS16 A35AK			AS38 ASS22 A35AM	AS46 ASS20 A35BL				AS52 ASS30 A35DM

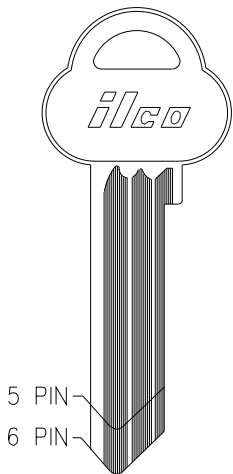
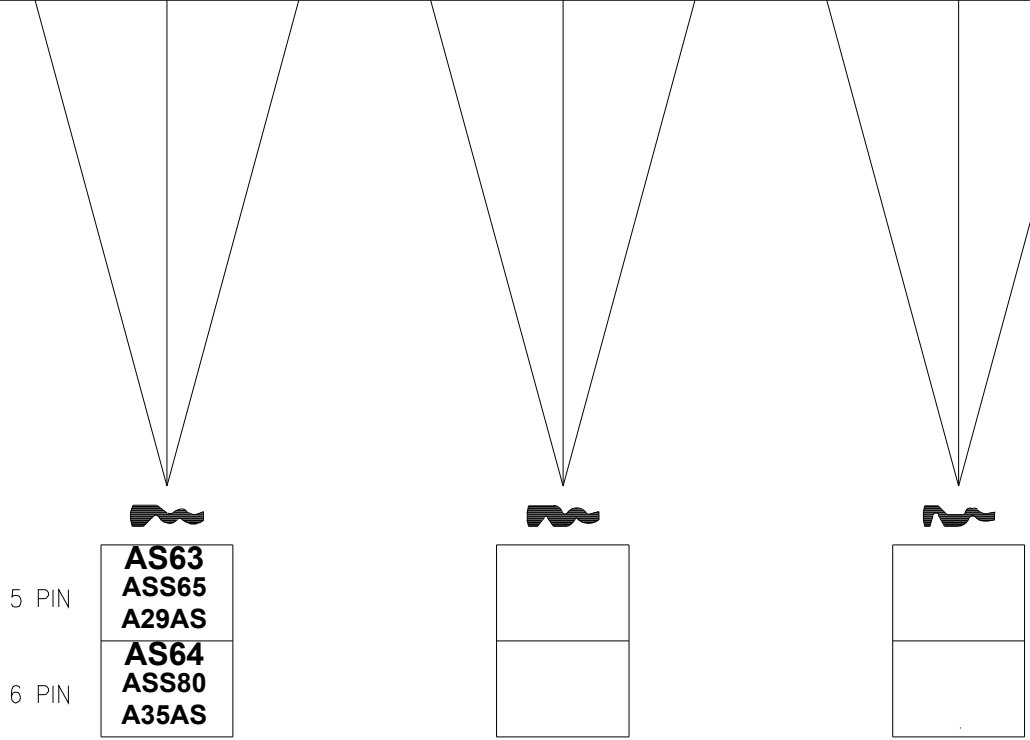

INTERNATIONAL CYLINDER



ASSA



5 PIN	AS17 ASS65 A29EK	AS13 - A29EL	AS27 - A29GK	AS47 - A29GL	AS53 AS29R A29GM
7 PIN	AS18 - A35EK	AS14 ASS14R A35EL	AS28 ASS26R A35GK	AS48 ASS28R A35GL	AS54 AS30R A35GM

5 PIN

AS61
ASS65R
A29ES

7 PIN

AS59
ASS67R
A29GS

AS60
ASS82R
A29GS

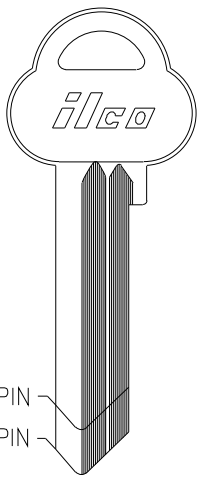

5 PIN
7 PIN

ILCO
SILCA
ORION

ALPHA

ASTRA

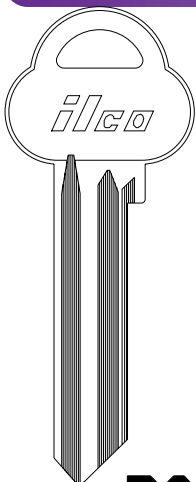

AS72
-
A35D

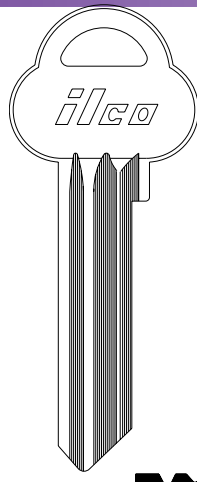

AS84
-
-

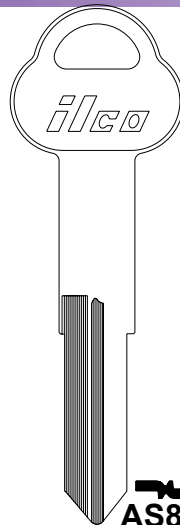

AS86
ASS61
-

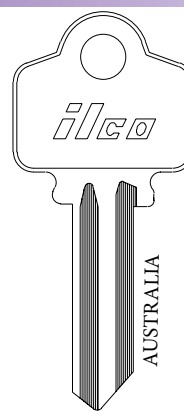

AT1
-
-

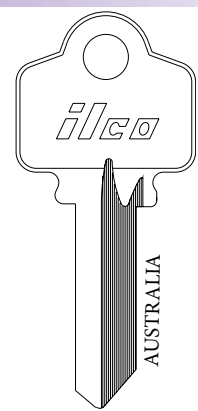

AT2
-
-

ILCO
SILCA
ORION



INTERNATIONAL CYLINDER



AUSTRAL

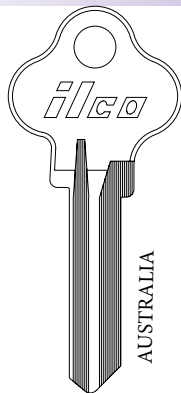

AZBE

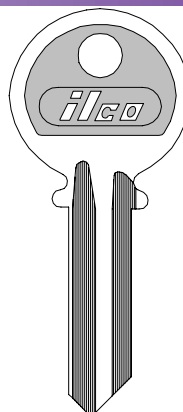
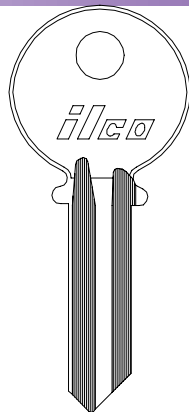
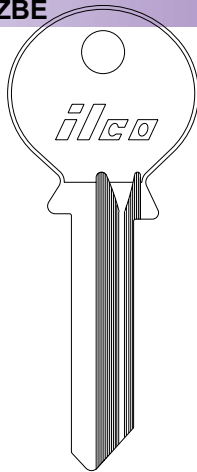

BETA

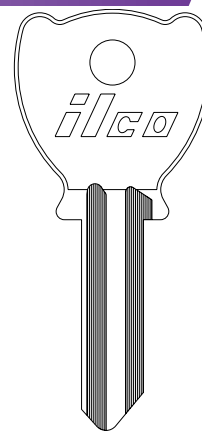

ILCO
SILCA
ORION

AUS1
-
-

AZ1R AZ2R
AZ1R AZ1
AZB11L AZB11

999
Y1
YAL13

999R
YA1R
-

Y1-PC
-
-

BT1
-
BT4A

BT3
-
BT4AL

BKS

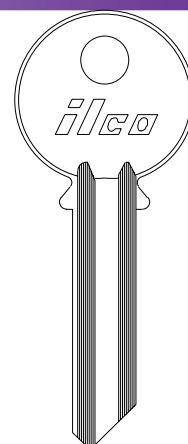
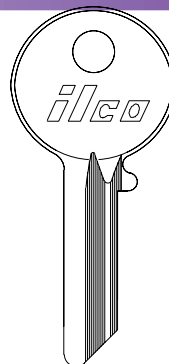
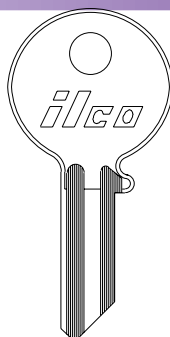
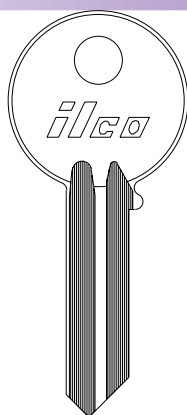
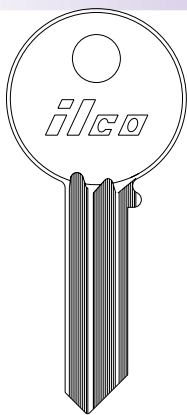

ILCO
SILCA
ORION

BKZ1
YA9
YAL21

X999
YA1
BKS10

997EB
YA8
YAL10

997ER
YA3R
YAL12L

999A
YA5
YAL15

BKS

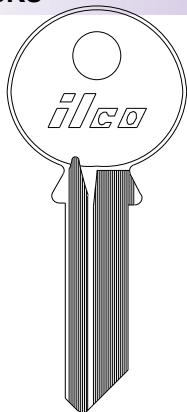

999GB
GYB
YAL13B

999GC
GYC
YAL13C

999GD
GYD
YAL13D

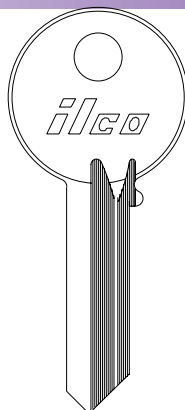

X999
YA1
BKS10

ILCO
SILCA
ORION

999GA
GYA
YAL13A

999GR
GYA
-

BLACK & DECKER

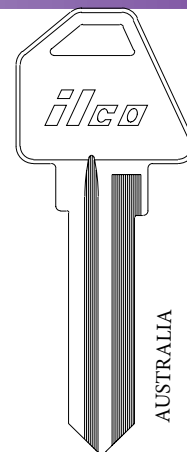

LH10
-
-

BLAU

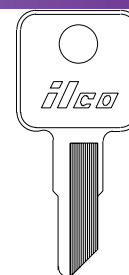

BU4
HM1
-



BLAU

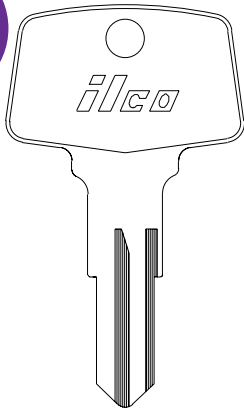

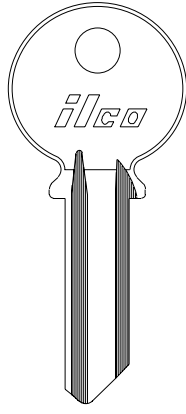

BU8
BTU
-

BLOCUS



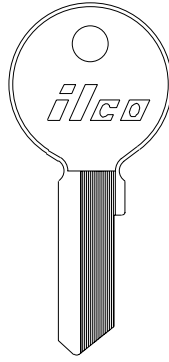

61JD
R08
RN16

BROTHERS

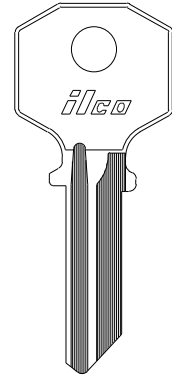
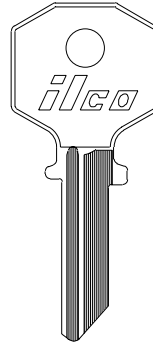

BS1
-
-

BURG





BUR7
BUR2
BRG11

BUR8
BUR2R
BRG11L

BUR11
BUR1
BRG12

ILCO
SILCA
ORION

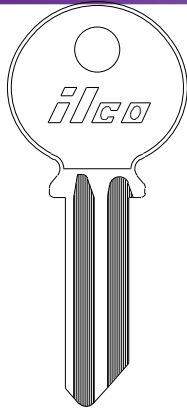
CENTURY



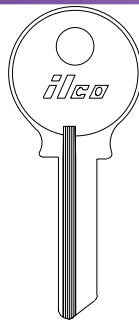

CE1
CEN1
-

C.E. SCHLUTE



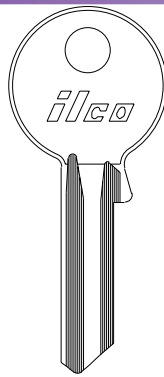

CS1
-
-



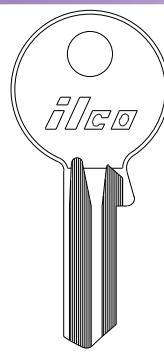

CS10
-
CE11



CS11
-
CE11L

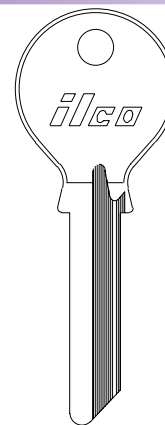



CS12
CE7
CE20

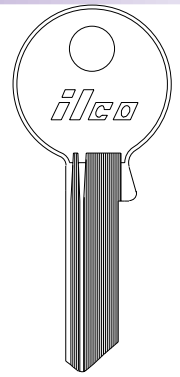



CS26
-
-



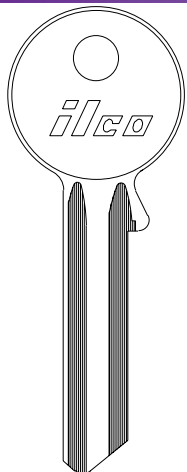

CS29
CE8
CE16

ILCO
SILCA
ORION

C.E. SCHLUTE



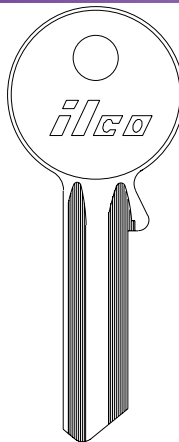

LR62US
CE1R
CE15L



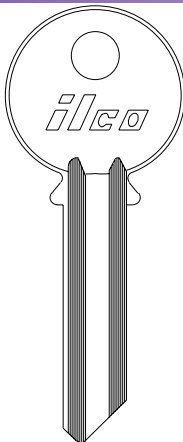

R62US
CE2R
CE14L



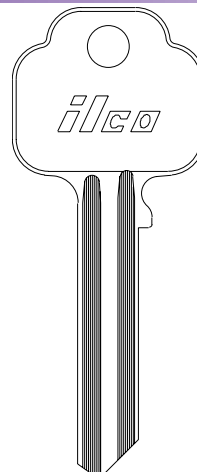

999A
YA5
-

CHUBB



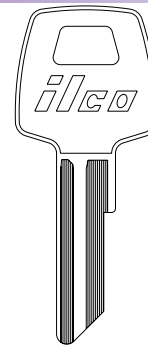

1516
CHU6
CH6

CISA



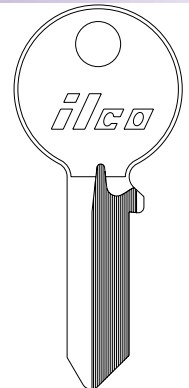

9CX
CA10
CSA20



NSR9CS
-
CSA4L

ILCO
SILCA
ORION

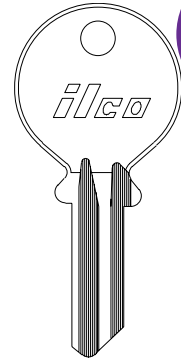
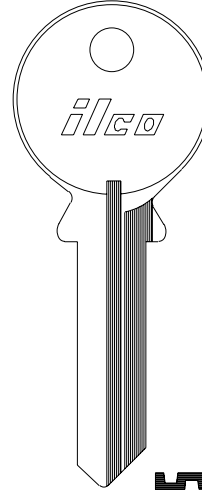
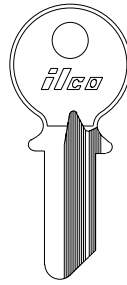
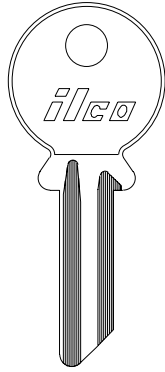
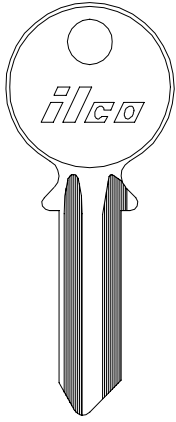
CISA



ILCO R9CS 9CS
 SILCA - CS206
 ORION - -

ILCO AB62E AB62ER
 CS7 CS7R
 - -

ILCO AB62GR
 CS9R
 -

ILCO AB1
 CS501
 -

ILCO CS91CR CS91C
 CS6 CS6R
 - -

CISA

CLICK-IT

COLE-HERSEE

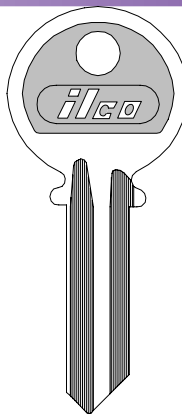
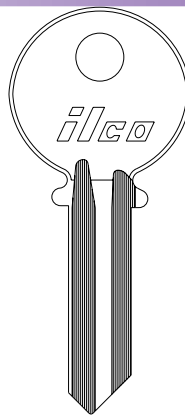
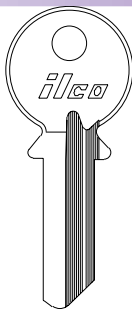
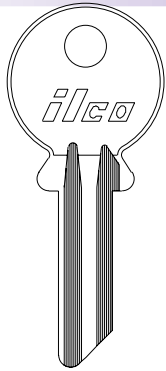

SEE
TAYLOR

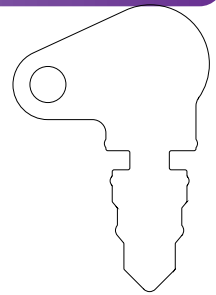

ILCO ILCOC91E CS91ER CS91F
 SILCA CS7 CS7R CS8R
 ORION - - -

ILCO CS91FR 999 999R
 CS8 YA1 YA1R
 - YAL13 -

ILCO Y1-PC
 -
 -

ILCO 1147
 -
 -

COLE-HERSEE

DOM

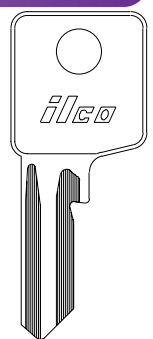
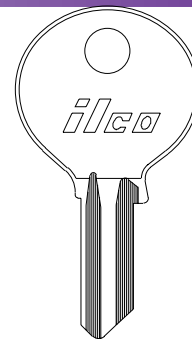
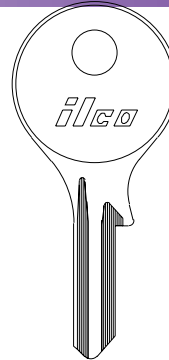
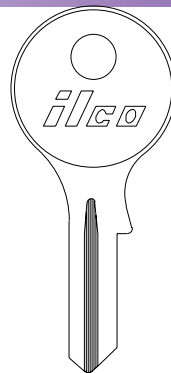
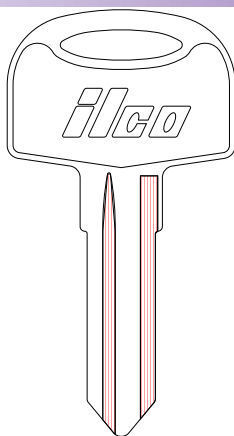
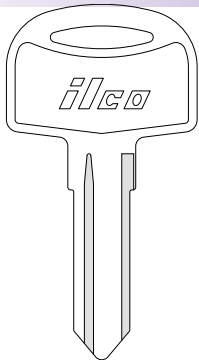

ILCO 1679 1679R
 SILCA - -
 ORION - -

ILCO 1689 1689R
 - -
 - -

ILCO DO1M
 DM4R
 -

ILCO DM10
 DM8
 DO12

ILCO DM11
 DM11
 DO18

ILCO DM21
 DM16
 DO71

INTERNATIONAL CYLINDER





DOM

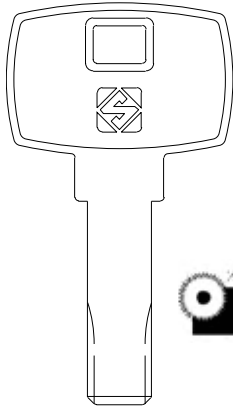

DM22-SI
DM22
-

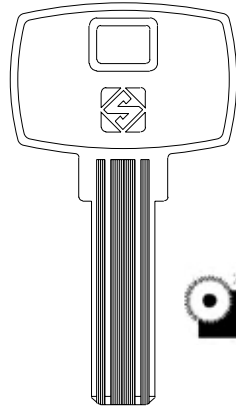

DM22TVP
DM22TVP
-

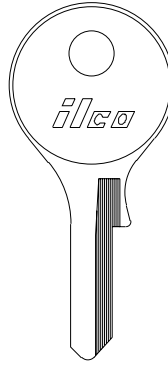

DM23
DM39R
DO84L

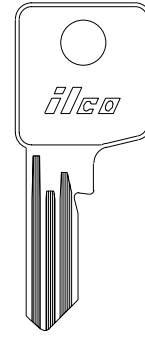

DM24
-
DO129

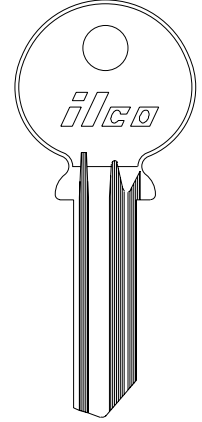

DM57
-
ILCO
SILCA
ORION



INTERNATIONAL CYLINDER

DOM

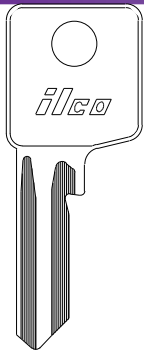

DM62
-
-

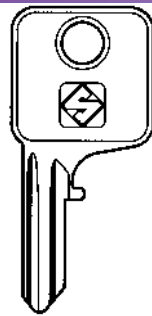

DM110
-
-

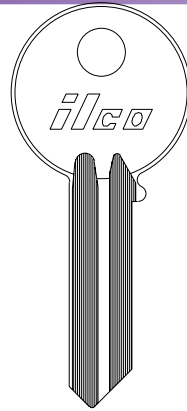

X999
YA1
BKS10

DOMWARE

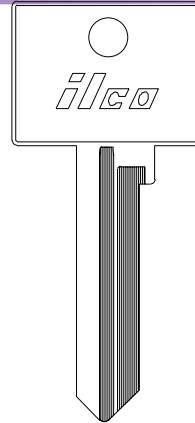

DW2
-
-

EFCO

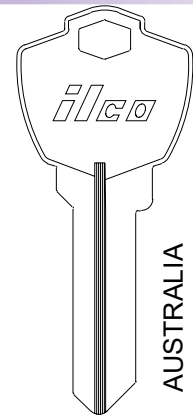

EC1
-
-

AUSTRALIA

ILCO
SILCA
ORION

EFCO

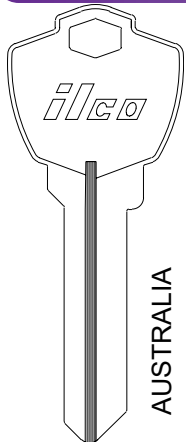

EC2
-
-

AUSTRALIA

EGO

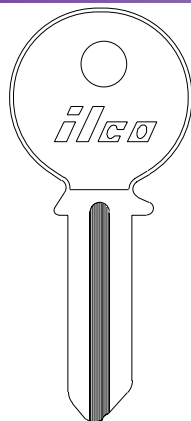

EE1
EGO1R
EGO12L

F.A.C.



9FAC
FAC11
-



ILCO
SILCA
ORION

F.A.C

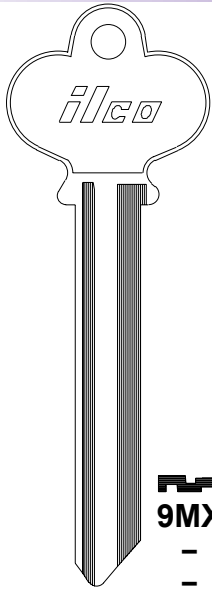

ILCO
SILCA
ORION

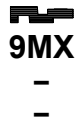

9MX
-
-

FCV-FLIETHER

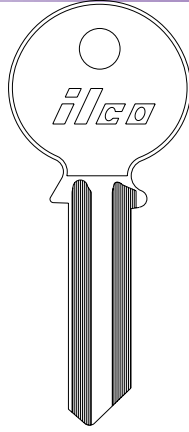

KFV1
KF1
-

FICHET

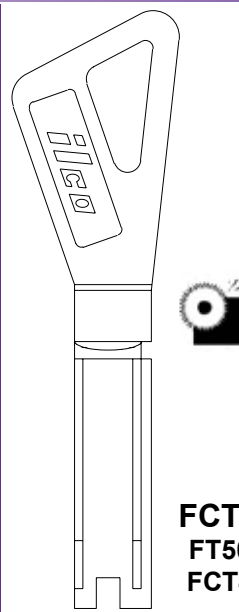

FCT45
FT500
FCT45

FIRMA DOOR

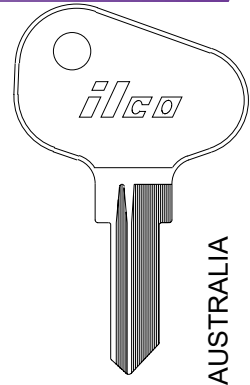

AUSTRALIA

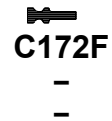

C172F
-
-



FTH

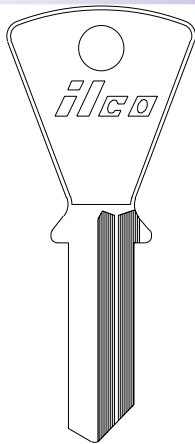

ILCO
SILCA
ORION



FTH5
FH6
FTH14

GAINSBOROUGH

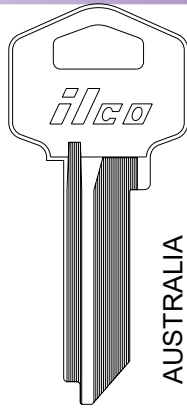

AUSTRALIA

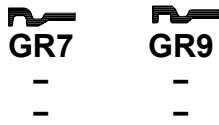

GR7
-
-
GR9
-
-

GEGE

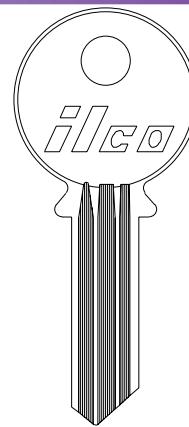

AUSTRALIA



GE15
-
-

GOAL

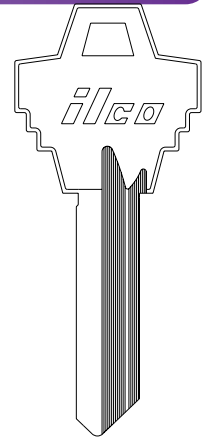

GL2
-
-

GOAL

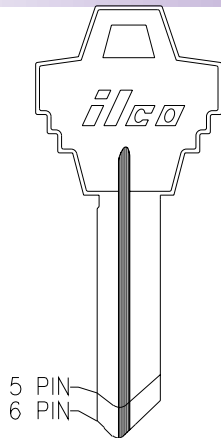

5 PIN
6 PIN

ILCO
SILCA
ORION



GL3
GO1R
GOL10L



GL1
GO2R
GOL11L

GUARD

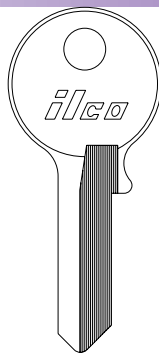

VR91AR
VIO82
VRO5P

GUERVILLE

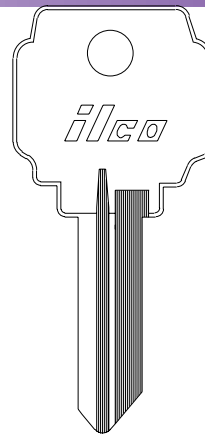

GU91F
RIQ3
-
GU91G
RIQ2
-

HALO

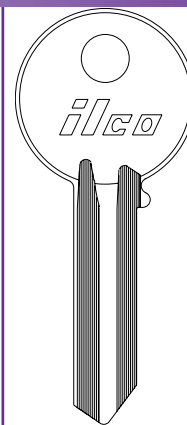

HL1
-
-

HORSE

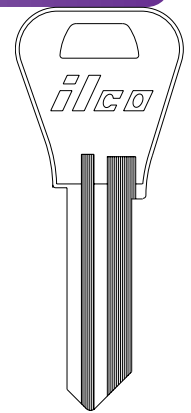

HS1
-
-

INTERNATIONAL CYLINDER



HUWILL

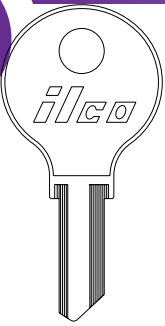

HU2
-
-

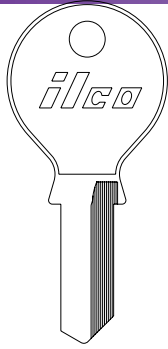

HU3
-
HWL12

I.G.S.

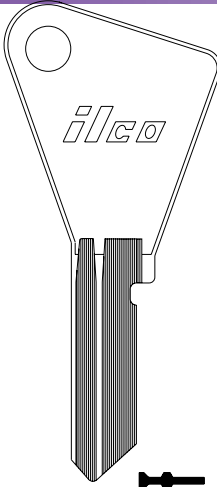

IGS1
-
-

ILCO AUSTRALIA



ILP20
-
-



ILP25
-
-



ILP30
-
ILCO
SILCA
ORION

AUSTRALIA

AUSTRALIA

AUSTRALIA

ILCO AUSTRALIA

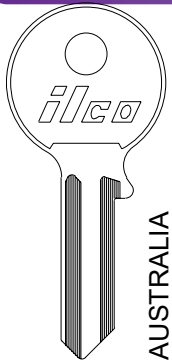

ILP40
-
-

AUSTRALIA

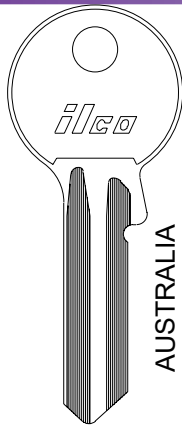

ILP50
-
-

AUSTRALIA

J.D.

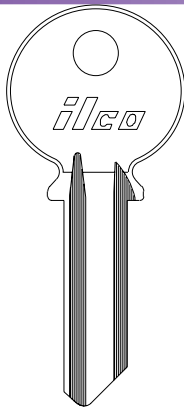

61JD
RO8
RN16

J.M.A.

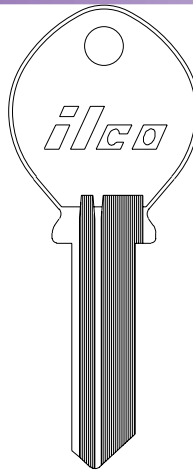

UCM1
AC1
-

KABA

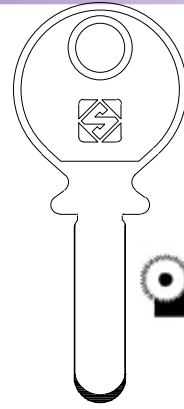

KA5-SI
KA5
-

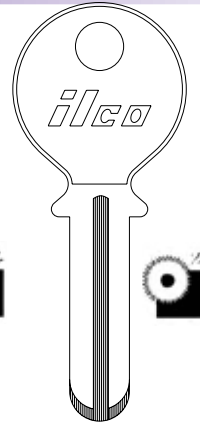

KAB1
KA1
-

ILCO
SILCA
ORION

KABA

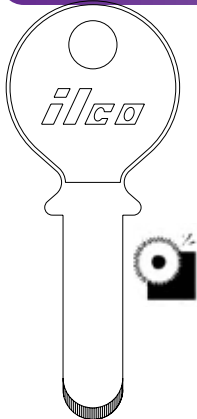

KAB2
KA2
-

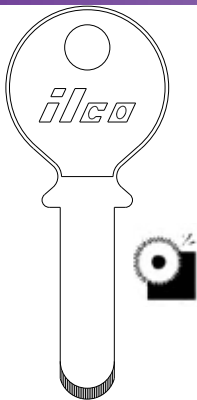

KAB3
-
-

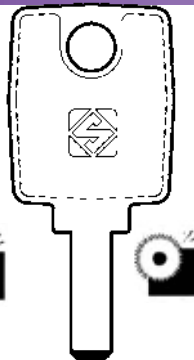

KA8-SI
-
-

KAWAKAMI

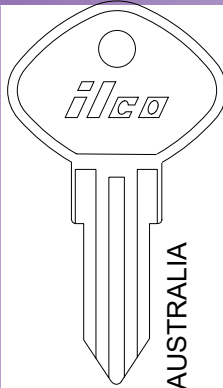

S6-AUS
-
-

AUSTRALIA

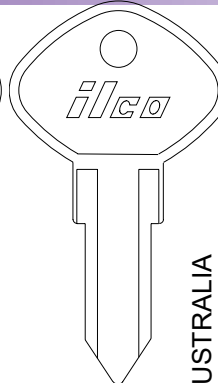

S7-AUS
-
-

AUSTRALIA

KUMAHIRA

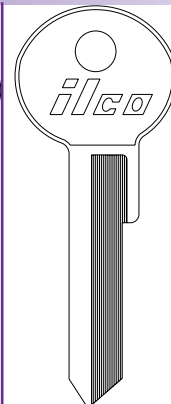

184K
-
-

ILCO
SILCA
ORION



LANES

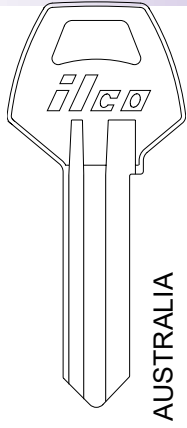

AUSTRALIA



ILCO LH1
SILCA -
ORION -

L.A.S.

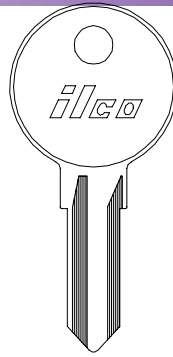
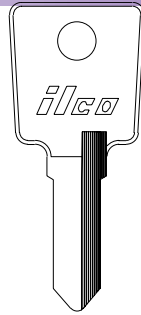
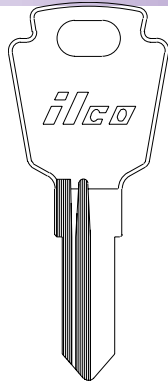

L4RM
LS21
-



L6FM
LS14
LAS2



L6S
LS13
LAS1



KM8
LS1
-

LINCE (ALSO SEE ELGIN IN SECTION 2)

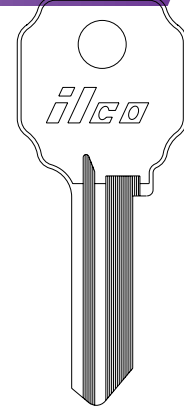
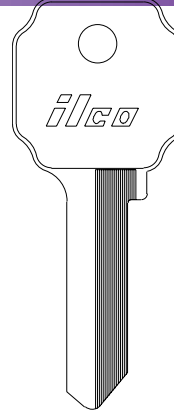

LC8
LC2R
-



S1096G
ELG10
LC11

LISTA

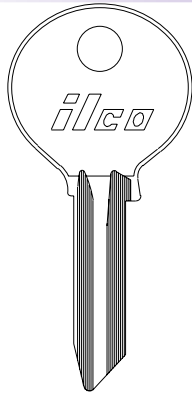

ILCO H64E
SILCA H64E
ORION DM7

LOCKWOOD AUSTRALIA

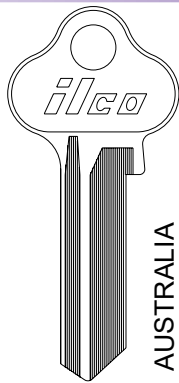

AUSTRALIA

4 4R
- -
- -

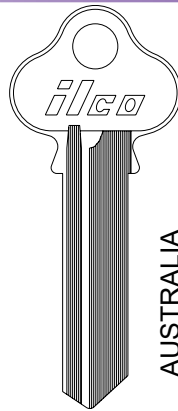

AUSTRALIA

LK1
-
-



LK2
-
-



LK3
-
-



LK4
-
-



LK5
-
-



LK6
-
-



LK7
-
-



LK8
-
-



LK9
-
-



LK10
-
-



LK13
-
-

LOCKWOOD AUSTRALIA

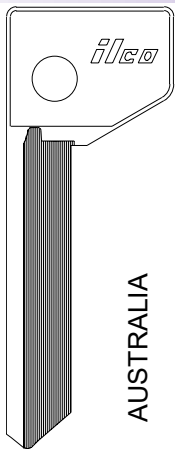

AUSTRALIA

ILCO LK21
SILCA -
ORION -

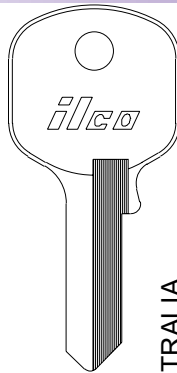

AUSTRALIA

LWC1
-
-



AUSTRALIA

LWC2
-
-

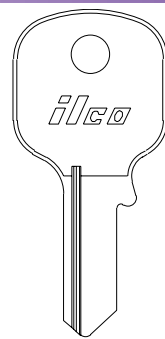

AUSTRALIA

LWC3 LWC3R
- -
- RIQ2

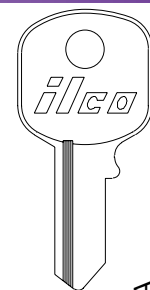

AUSTRALIA

LWC4 LWC4R
- -
- -



LOCKWOOD AUSTRALIA

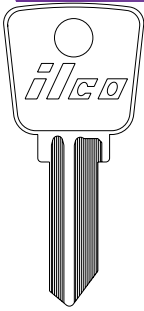

AUSTRALIA

24
-
-

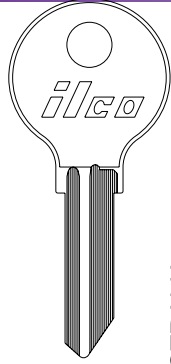

AUSTRALIA

24A
-
-

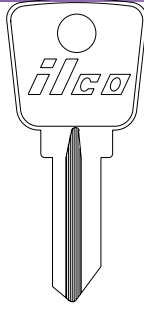

AUSTRALIA

25B-AUS
-
-

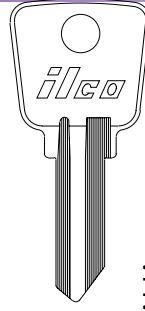

AUSTRALIA

24CL
-
-

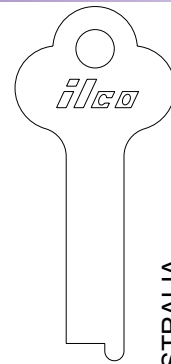

AUSTRALIA

201-AUS
-
-

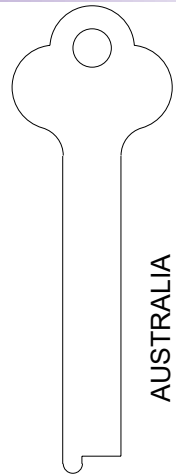

AUSTRALIA

202
-
-

ILCO
SILCA
ORION

LOWE & FLETCHER

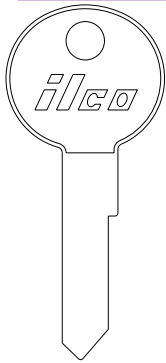

LF1
LF6R
-

LF2
-
-
LF3
-
-

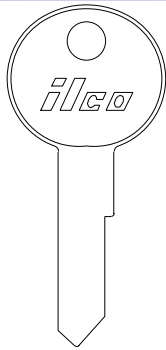

LF5
LF4
-

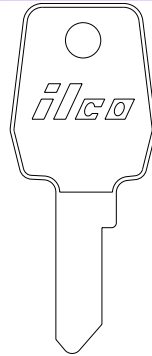

LF6
LF13
LF23

LF10
LF17
LF26
LF11
-
-
LF16
LF15R
LF25L

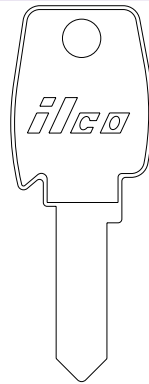

LF7
LF2
LF12

LF8
-
-
LF9
-
-

ILCO
SILCA
ORION

LOWE & FLETCHER

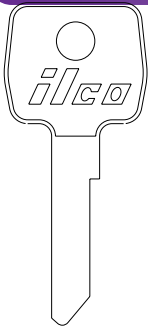

LF14
LF11
LF21

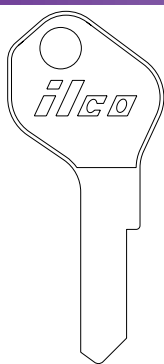

LF18
LF31R
LF39L

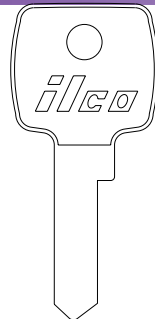

LF19
LF4
LF32

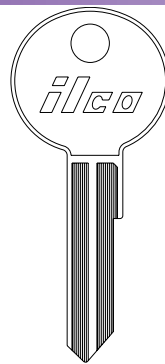

LF21
-
-

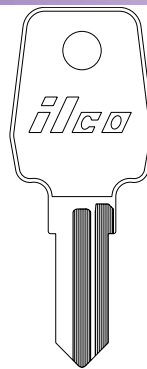

LF23
-
-

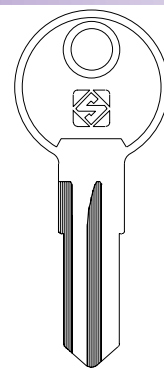

LF12-SI
LF12-SI
-

ILCO
SILCA
ORION

INTERNATIONAL CYLINDER





LOWE & FLETCHER

LOWE & FLETCHER (AUSTRALIA)

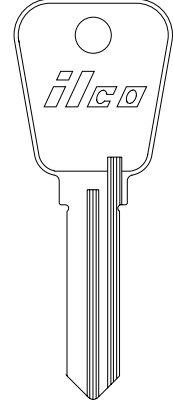
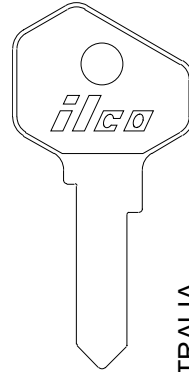
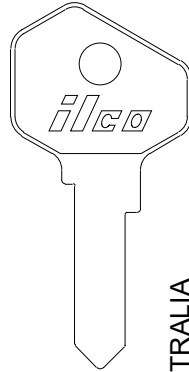
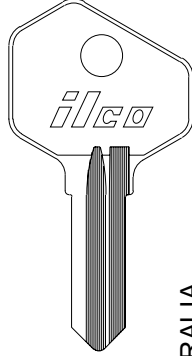
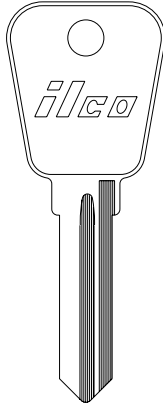

AUSTRALIA

AUSTRALIA

AUSTRALIA

AUSTRALIA

ILCO
SILCA
ORION

LF24
LF19
-

C209
-
-

LF20
-
-



LF20S
-
-

LF25
-
-

MERONI

MIWA

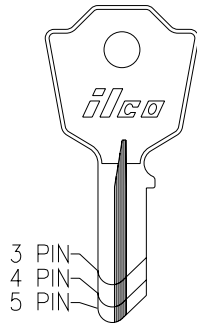
MUL-T-LOCK * (Compatible)



4 PIN
ME1
MER6
MRN3P
5 PIN
ME3
MER6
MRN3P

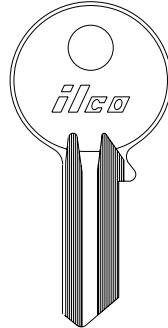

ME2
MER1
-

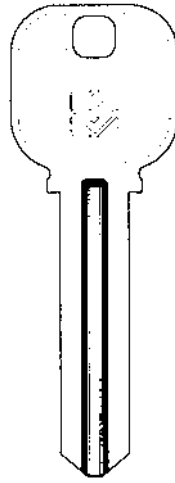

MIW2
MIW2
-

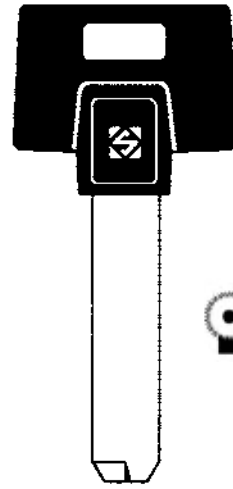



MTK2P
MTK2P
-

ILCO
SILCA
ORION

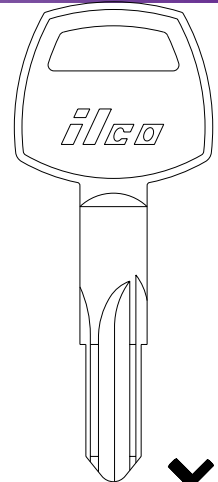
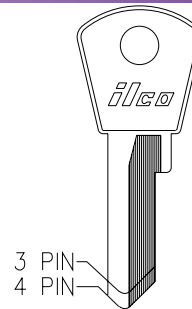
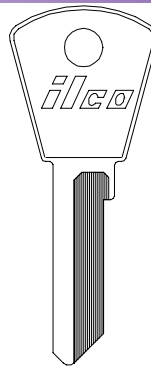
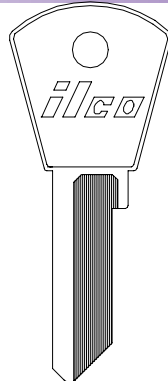
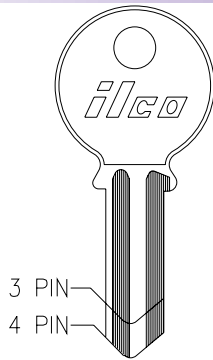

ME6
MER6
MRN3P

ODA

PAPAIZ



ILCO
SILCA
ORION

AK1
AK1R
ANK10
AK2
AKR2
AMK11

PZ1
PZ1
PA10

PZ2
PZ2
PA11

PZ4
PZ4
PA13
PZ3
PZ3
PZ12

XPA1
XPZ1
XPA1



*Mul-T-Lock is a trademark of a third party not affiliated or linked with Kaba Ilco or the Dormakaba Group.



INTERNATIONAL CYLINDER

SEC
PG 298

PAPAIZ

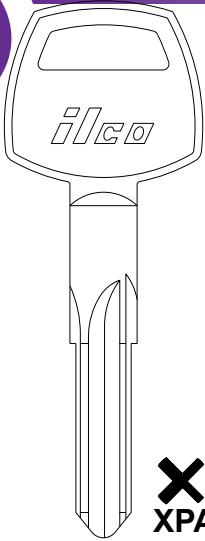

X
XPA2
XPZ1
XPA2

PREFER

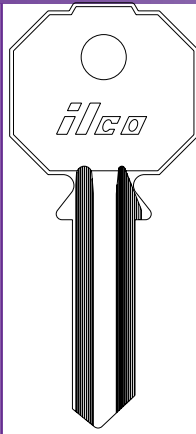

PR91C
PFO92S
PRF28F

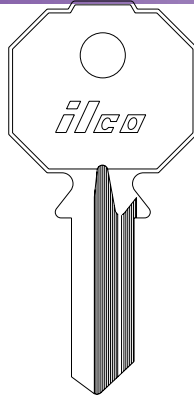

PR91CS
PF2S
PRF4SF

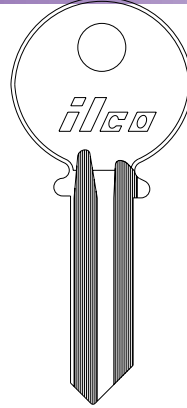

999
YA1
YAL13

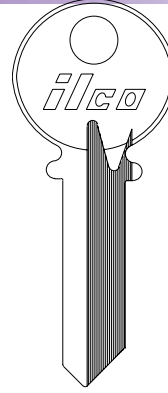

999R
YA1R
-

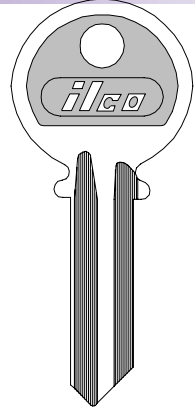

Y1PC
-
-

ILCO
SILCA
ORION

RICOUARD

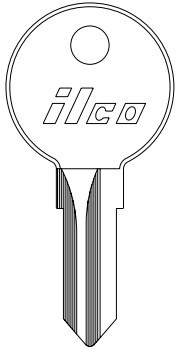

KM2
KI10
-

KM8
LS1
-

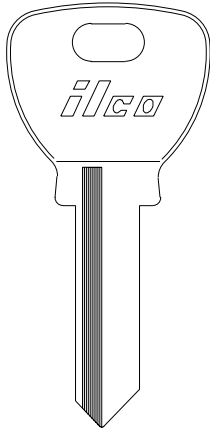

GU4R
RIQ1R
GRQ1R

ROLL A DOOR (AUSTRALIA)

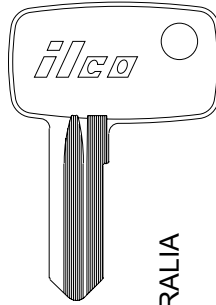

AUSTRALIA

C219
-
-

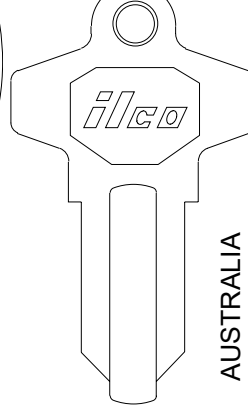

AUSTRALIA

ORD1
-
-

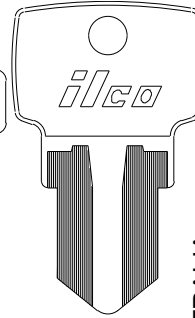

AUSTRALIA

RD1
-
-

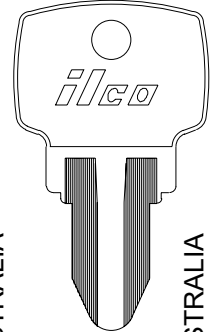

AUSTRALIA

RD2
-
-

ILCO
SILCA
ORION

ROLL A DOOR

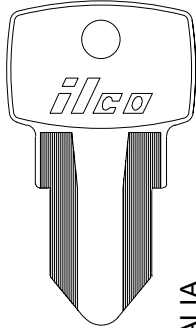

AUSTRALIA

RD4
-
-

ROLL-IT

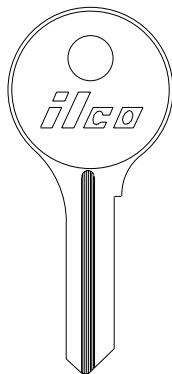

RL1
RL1
-

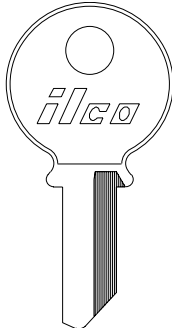

RL2
RL2
-

RONIS

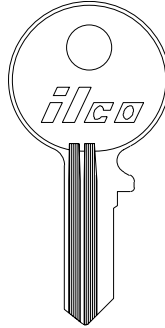

R16
RO60
-

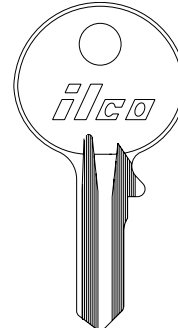

7DC
RO20
RN11

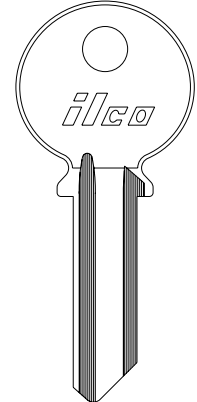

61JD
RO8
RN16

R61JDILCO
RO8R SILCA
RN16L ORION



RONIS

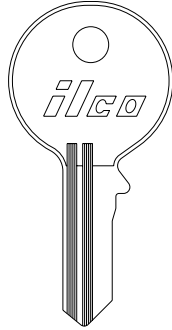
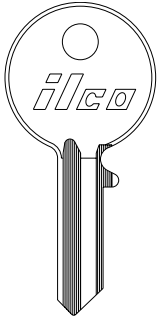

SANWA (AUSTRALIA)

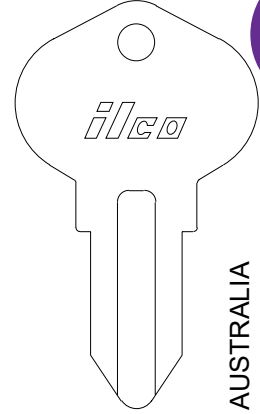
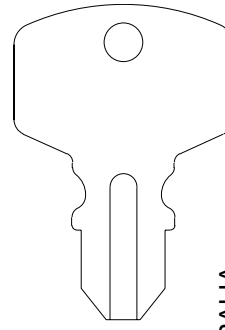
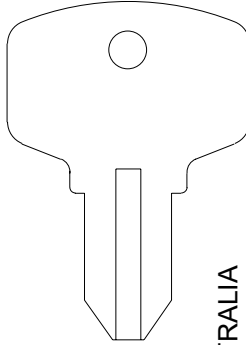

 **ILCO HV61**
 **HVR61**
 **V61S**
 **VR61S**
SILCA RO21 **RO21R** **RO4** **RO4R**
ORION RN10 **RN10L** **RN13** **RN13L**

 **S1-AUS**
 -
 -
 **S2-AUS**
 -
 -
 **S3-AUS**
 -
 -

AUSTRALIA

AUSTRALIA

AUSTRALIA

SANWA (AUSTRALIA)

S & G

SESA

SIDLEEN

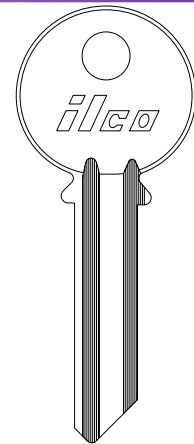
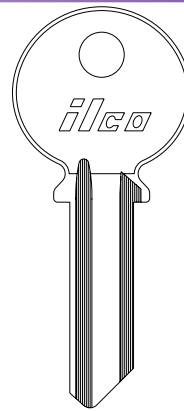
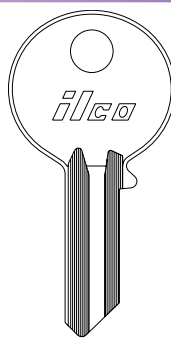
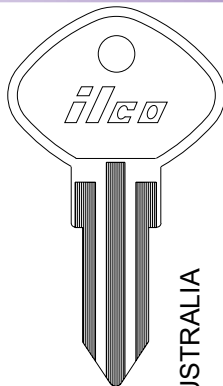
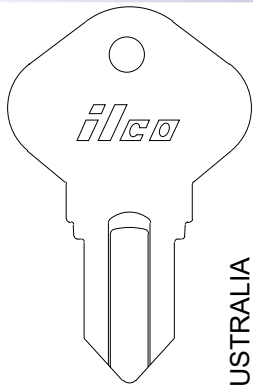

AUSTRALIA

AUSTRALIA

ILCO
SILCA
ORION
 **S4-AUS**
 -
 -

 **S9-AUS**
 -
 -

 **SG2**
 -
 -

 **61JD**
RO8
RN16

 **EX1**
SD1
SLE10

SIMECA

SIS

SQUIRE

SUREX

SWEDA

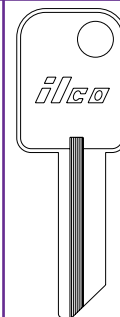
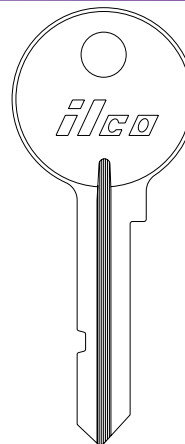
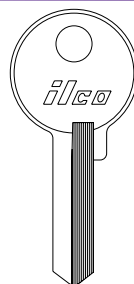
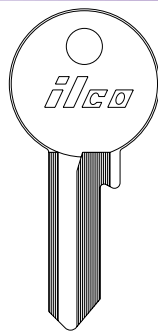
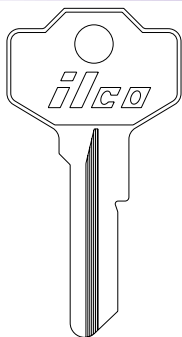

 **SW2**
SW2
 -

ILCO
SILCA
ORION
 **SIM2**
SM1
SMG10

 **1523**
SS10
 -

 **192**
SQ1
 -

 **192B**
 -
 -

 **SX4**
PZ3
SRX15

 **SW1**
SW1
 -





TESA * (Compatible)

TRI-CIRCLE

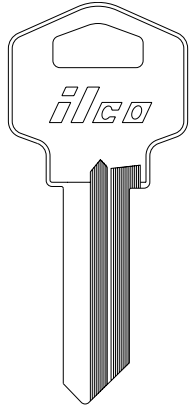

TE1
TE1
TSA10

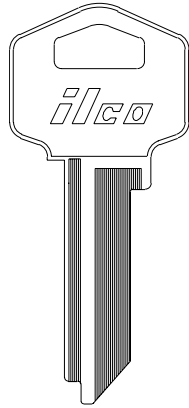

TE2
TE1R
TSA10L

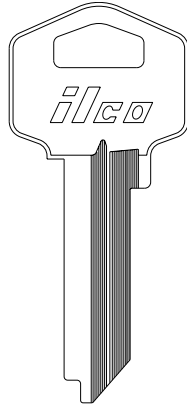

TE3
TE3
TSA11

TE4
TE2
TSA12

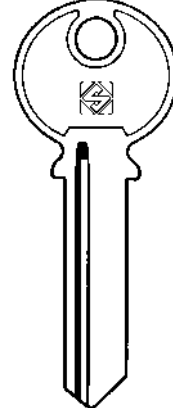

TL8
TL8R
-

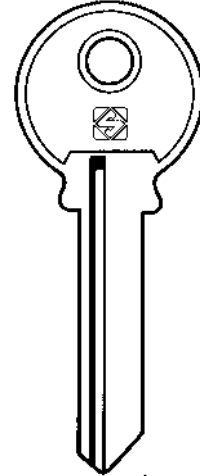

TL11
TL11
-

ILCO
SILCA
ORION

TRI-CIRCLE TRIO

UCEM

UNION

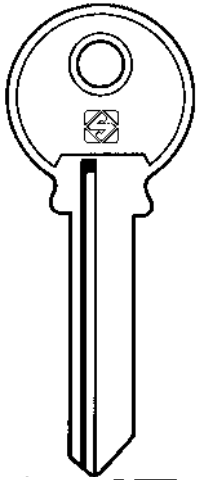

TL11R
TL11R
-

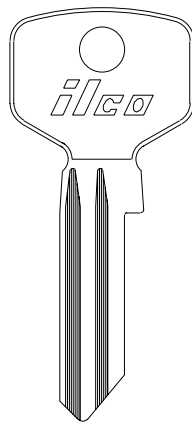

TO5
TR3
TO5

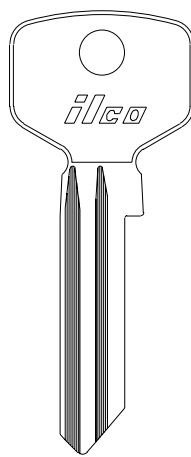

TO6
TR4
-

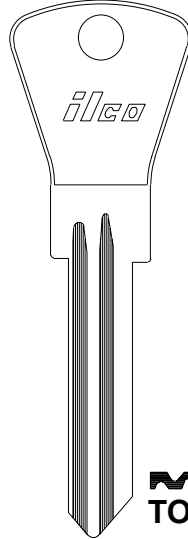

TO7
-
-

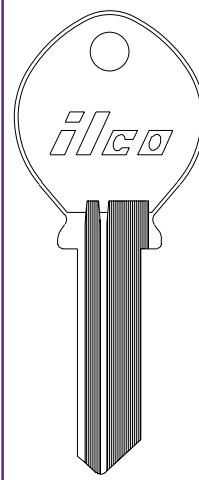

UCM1
AC1
-

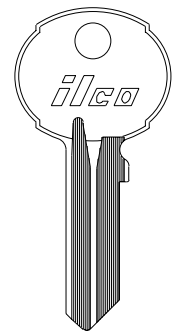

UN5
UN127
UN36

ILCO
SILCA
ORION

UNION

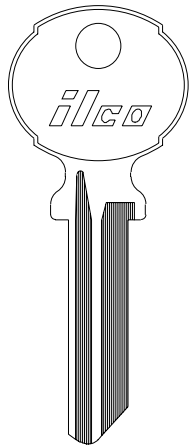

33NO
UNI3
-

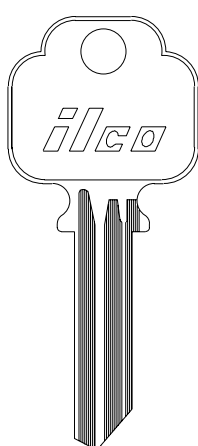

UN51
UNI33
-

UN54
UNI38
-

UN68
UNI36R
-

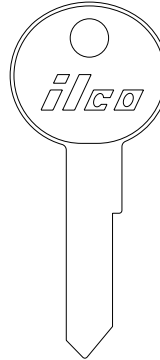

L62DM
UNI29
UN37

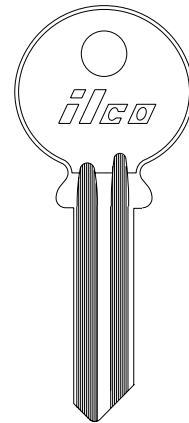

1033
-
UN13

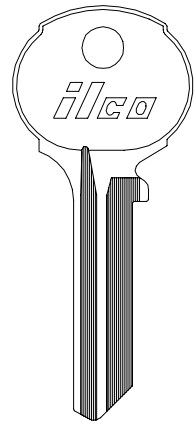

1033N
UNI3
UN12
ILCO
SILCA
ORION

INTERNATIONAL CYLINDER

SEC
PG
300

*Tesa is a trademark of a third party not affiliated or linked with Kaba Ilco or the Dormakaba Group.





VAUGHAN

VIRO

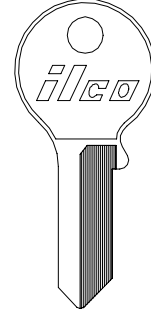
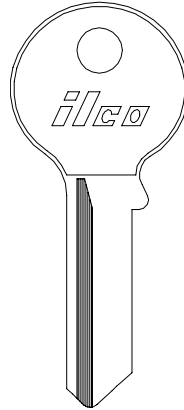
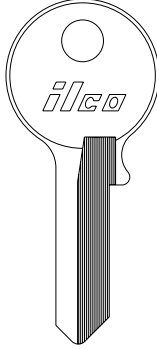
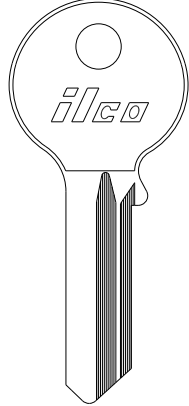
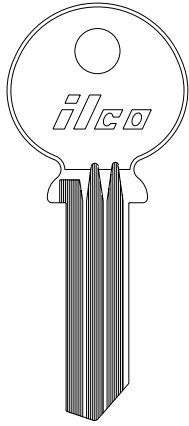

 VR91BR
VIO85
VRO4PL

 L67A

ILCO
SILCA
ORION

 VA1
HT2
-

 VR1
VI1R
VRO5XL

 VR91A
VIO87
VRO5PL

 VR91AR
VIO82
VRO5P

 VR91R
VIO81
VRO5

 VR91
VIO80
VRO5

 VR91B
VIO84
VRO4P

VIRO

WHITCO

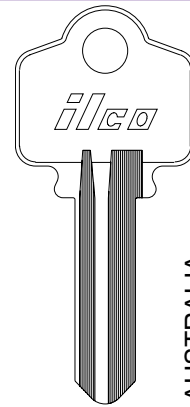
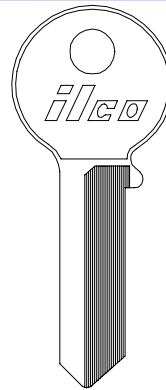
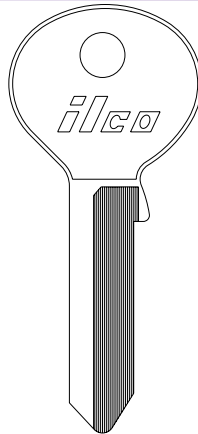
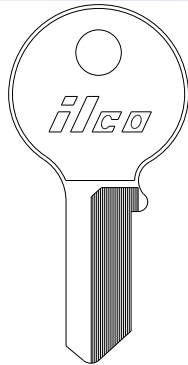

AUSTRALIA

ILCO VR91C
SILCA VIO89
ORION VRO3PL

 VR91CR
VIO88
VRO3P

 VR91S
VIO82
VRO4

 185V
-
-

 R185V
-
-

 191A
GD2
-

 WO1
-
-

WHITCO

WILKA

YALE

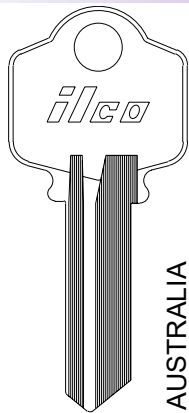

AUSTRALIA

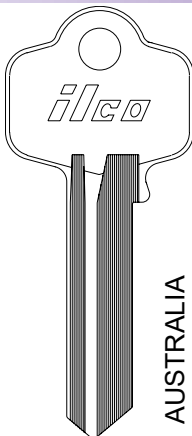

AUSTRALIA

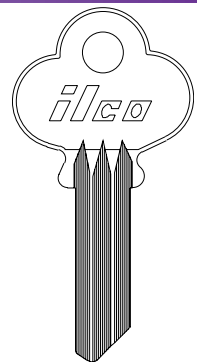
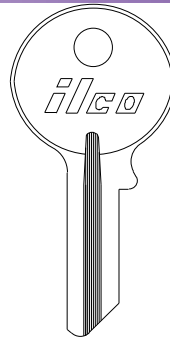
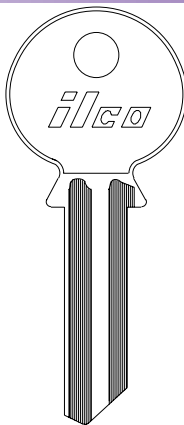

ILCO
SILCA
ORION

 WO2
-
-

 WO3
-
-

 W91C
WK1
WIL10

 YL5
YA15
-

 S7JA
-
-

 Y8
-
-





YALE * (Compatible)

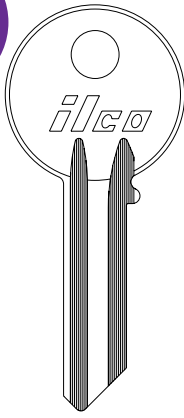

14KH
YA226
-

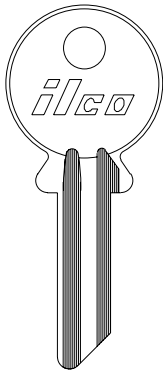

Y200
YA3
-

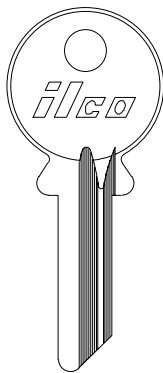

Y204
CS204
-

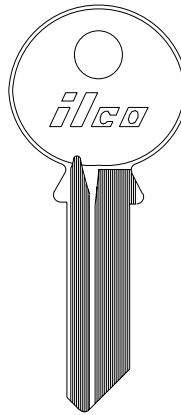

999GA
GYA
YAL13A

999GB
GYB
YAL13B

999GC
GYC
YAL13C

999GD
GYD
YAL13D

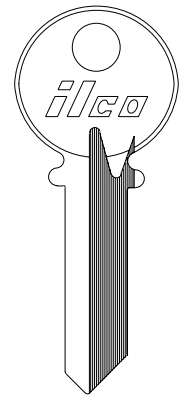

999R
YA1R
-

ILCO
SILCA
ORION

ZADA

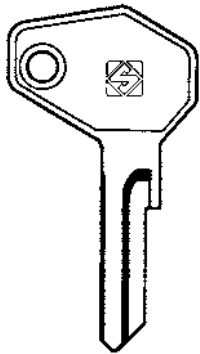

ZD7
ZD7
-

ZEISS-IKON

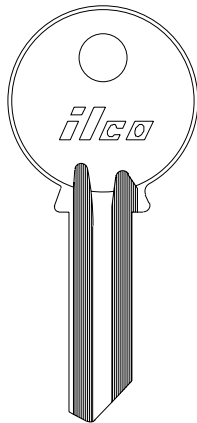

ZKN1R
ZE1R
-

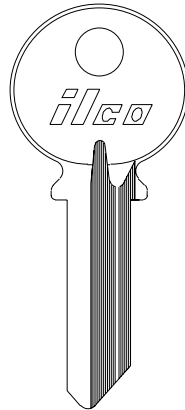

ZKN2
ZE1R
-



S60
-
ZE112

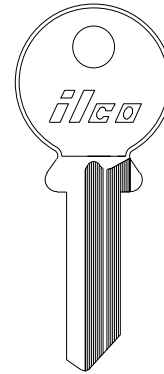

S60R
-
ZE112L

ILCO
SILCA
ORION

INTERNATIONAL CYLINDER



**SECTION 4A
ORIGINALS**

Key Blanks with the authorized Original Manufacturer's logos and/or designs.

**SECTION 4B
LOOK ALIKE® CYLINDERS**

Key Blanks manufactured to look just like the Original Manufacturer's key, without the brand name.

**SECTION 4C
LOOK ALIKE® REMOTES**

Remotes manufactured to look just like the Original Manufacturer's remotes, without the brand name.

Look Alike Key Number	Ilco Equivalent	Ilco EZ Equivalent	Fits	Finish	Look Alike Key Number	Ilco Equivalent	Ilco EZ Equivalent	Fits	Finish
320560	1970AM	RA4	American Motors	NP	1063KW-NP-250PK	1176	KW1	Kwikset	NP
320561	S1970AM	RA3	American Motors	NP	N1063KW	1176	KW1	Kwikset	NP
PTKB1	1045	AM3	American	BR	B308	1004	L1	Lockwood	NP
CH1C	B1179-1C	-	Arrow	NS	B310	1004A	L4	Lockwood	NP
CH1D	B1179-1D	-	Arrow	NS	15K	1092N	M16	Master	BR
K2-A	1179	AR1	Arrow	BR	1K	1092	M16	Master	BR
K7	1179A	AR4	Arrow	NS	1515	-	-	Medeco	NS
1A1A1	A1114A	BE2	Best	NS	1517	-	-	Medeco	NS
1A1B1	A1114B	-	Best	NS	1518	-	-	Medeco	NS
1A1C1	A1114C	-	Best	NS	1542	-	-	Medeco	NS
1A1D1	A1114D	-	Best	NS	1543	-	-	Medeco	NS
1A1DD1	A1114DD	-	Best	NS	1638	-	-	Medeco	NP
1A1E1	A1114E	-	Best	NS	1644	-	-	Medeco	NP
1A1F1	A1114F	-	Best	NS	1655	-	-	Medeco	NS
1A1FM1	A1114FM	-	Best	NS	A1515	-	-	Medeco	NS
1A1G1	A1114G	-	Best	NS	A1517	-	-	Medeco	NS
1A1H1	A1114H	-	Best	NS	A1638	-	-	Medeco	NP
1A1J1	A1114J	-	Best	NS	4295	R1064E	NA25	National	BR
1A1K1	A1114K	-	Best	NS	5981R	N1011P	RU52	Russwin	NS
1A1L1	A1114L	-	Best	NS	5D1R	1011D1	RU45	Russwin	NS
1A1M1	A1114M	-	Best	NS	6D1R	A1011D1	RU46	Russwin	NS
1A1Q1	A1114Q	-	Best	NS	275LA	1007LA	S22 1/2	Sargent	NS
1A1R1	A1114R	-	Best	NS	275S	1010N	S68	Sargent	NS
1A1TA1	-	-	Best	NS	6275LA-NP	01007LA	S22	Sargent	NP
1A1TB1	A1114TB	-	Best	NS	6275LA-NS	01007LA	S22	Sargent	NS
1A1WA1	-	-	Best	NS	100-C	1145	SC1	Schlage	NP
1A1WB1	-	-	Best	NS	100-C-250PK	1145	SC1	Schlage	NP
1A1WC1	-	-	Best	NS	100C-BR	1145	SC1	Schlage	BR
1A1WD1	-	-	Best	NS	100-C-NS	1145	SC1	Schlage	NS
1A1WE1	-	-	Best	NS	100C-NS-250PK	1145	SC1	Schlage	NS
1A1WG1	-	-	Best	NS	100-E	1145E	SC8	Schlage	NP
1A1WH1	-	-	Best	NS	100-E-NS	1145E	SC8	Schlage	NS
1A1WY1	-	-	Best	NS	101-C	1145A	SC4	Schlage	NP
K4	1041G	CG1	Chicago	BR	101C-BR	1145A	SC4	Schlage	BR
K5	C1041P	-	Chicago	BR	101C-BR-250PK	1145A	SC4	Schlage	BR
320433	S1768CH	-	Chrysler	NP	101-CE-NS	A1145CE	-	Schlage	NS
320514	1769CH	-	Chrysler	NP	101-C-NS	1145A	SC4	Schlage	NS
Z1-59A1-6	A1001AH	CO91	Corbin	NS	101C-NS-250PK	1145A	SC4	Schlage	NS
Z1-59A2-6	A1001FH	CO92	Corbin	NS	101E	A1145E	SC9	Segal	NP
Z1-59B1-6	A1001BH	CO94	Corbin	NS	101-EF-NS	A1145EF	-	Schlage	NS
Z1-59C1-6	A1001C1	CO98	Corbin	NS	101-E-NS	A1145E	SCC9	Schlage	NS
Z1-59C2-6	A1001C2	CO102	Corbin	NS	101E-NS 250PK	A1145E	SC9	Schlage	NS
Z1-59D2-6	A1001D2	CO108	Corbin	NS	101-F	A1145F	SC10	Schlage	NP
Z1-60-5	1001EH	CO87	Corbin	NS	101-F-NS	A1145F	SC10	Schlage	NS
Z1-60-6	A1001EH	CO88	Corbin	NS	180A	1370A	SC6	Segal	NP
67	D1054K	DE6	Dexter	BR	200W	1307W	SC22	Segal	NP
S54F	-	-	Dominion	NP	K9	1120D	SL1	Segal	BR
KB1577G	A1054WD	FA3	Falcon	NS	83559	A1176ST	KW10	Titan	NP
P1577E	A1054WC	FA2	Falcon	NS	08260KW	A1176ST	KW10	Titan	NS
113	1167FD	H51	Ford	NP	7743	-	-	Titan (Lg. Head)	NP
114	S1167FD	H50	Ford	NP	13D	VR91AR	VR7	Viro	NP
116	1184FD	H54	Ford	NP	15D	VR91AR	VR2	Viro	NP
GM-A	P1098A	B48	GM	NP	1555	1054WB	WR3	Weiser	NP
GM-B	S1098B	B49	GM	NP	1555-NP-250PK	1054WB	WR3	Weiser	NP
GM-C	P1098C	B50	GM	NP	1555-NS	1054WB	WR3	Weiser	NS
GM-D	S1098D	B51	GM	NP	P1555	N1054WB	WR5	Weiser	NP
GM-E	P1098E	B44	GM	NP	P1555-BR-250PK	N1054WB	WR5	Weiser	BR
GM-H	S1098H	B45	GM	NP	P1555-NS	N1054WB	WR5	Weiser	NS
GM-J	P1098J	B46	GM	NP	12344	1175N	WK2	Weslock	BR
GM-K	S1098K	B47	GM	NP	12344-NS	1175N	WK2	Weslock	NS
H20	1003M	CO106	Hudson	BR	8	999	Y1	Yale	BR
H21	R1003M	BO1	Hudson	BR	9114	1122	Y11	Yale	BR
1063KW	1176	KW1	Kwikset	NP	9278	01122A	Y12	Yale	BR
1063KW-BR	1176	KW1	Kwikset	BR	8 YALE-250PK	999	Y1	Yale	BR
1063KW-BR-250PK	1176	KW1	Kwikset	BR	E8	999N	Y1E	Yale	BR

GM

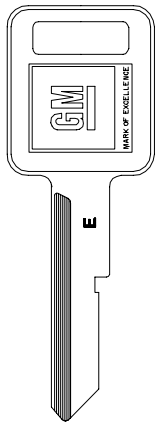

B46G

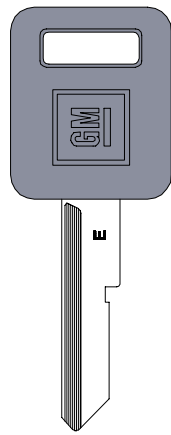

B48G

B46GP

B48GP

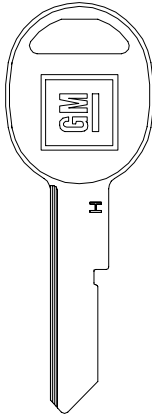

B47G

B49G

B51G

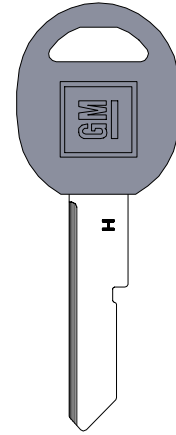

B49GP

B51GP

ILCO B44G

B44GP

B45G

B45GP

GM

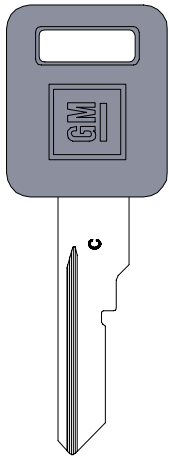

ILCO B63GP

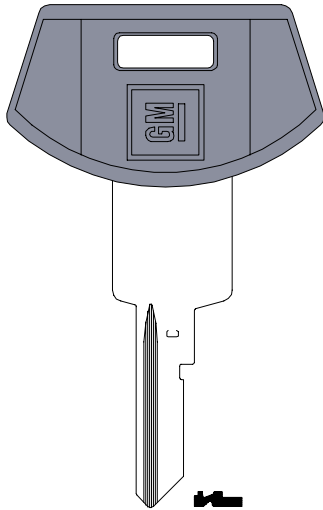

B64GP

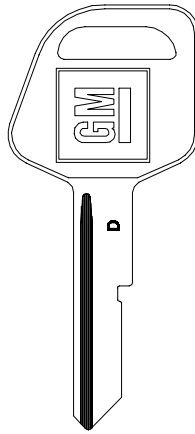

B67G

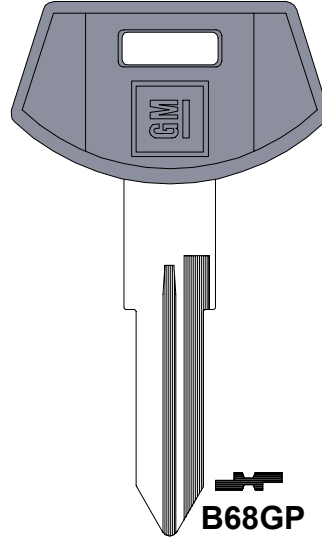

B68GP

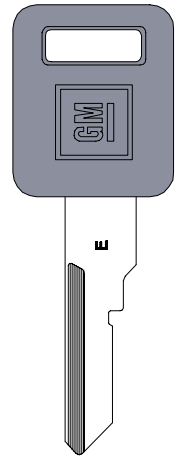

B77GP

GM

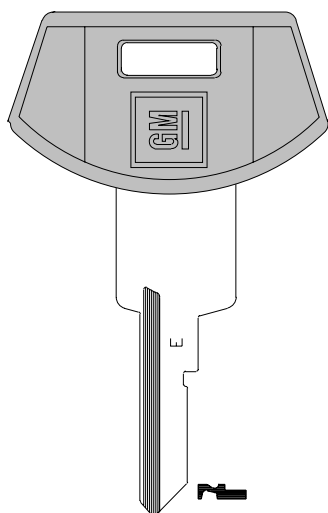

ILCO B78GP

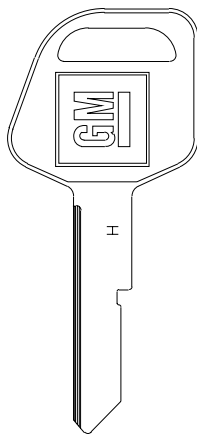

B79G

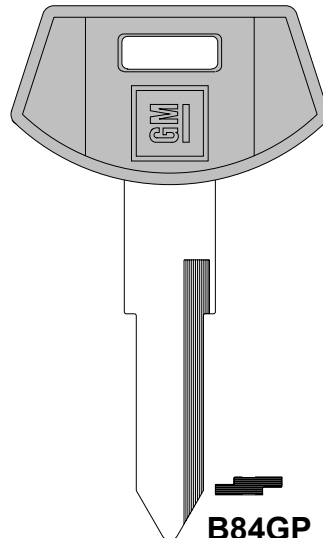

B84GP

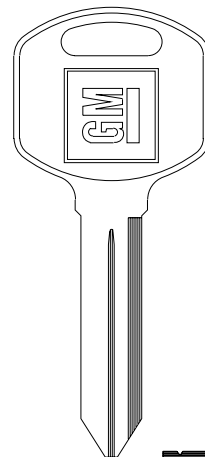

B85G

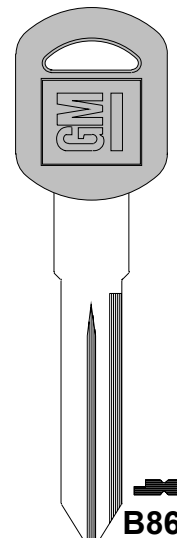

B86GP



ORIGINALS





GM

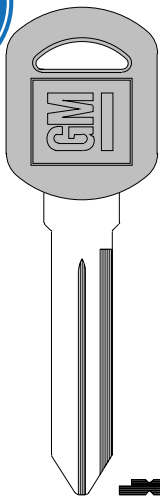

B89GP

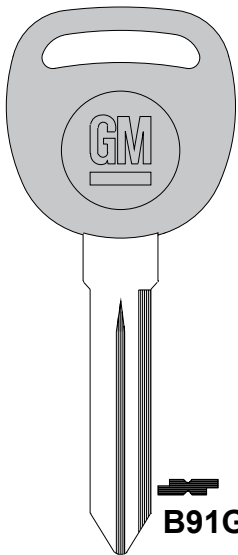

B91GP

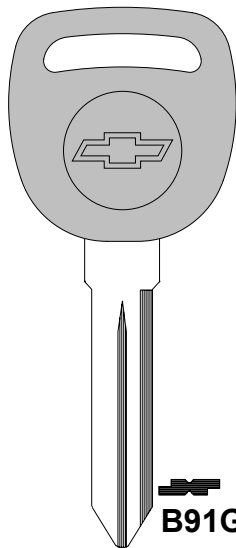

B91GCP

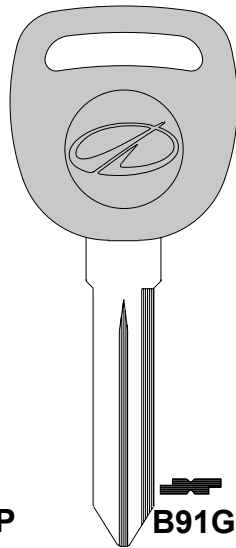

B91GOP

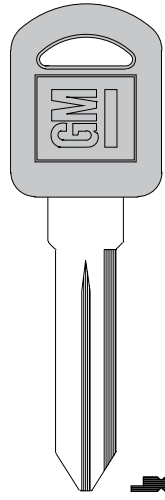

B92GP ILCO

GM

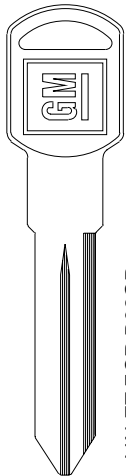

B92GV

VALET FOR B92GP

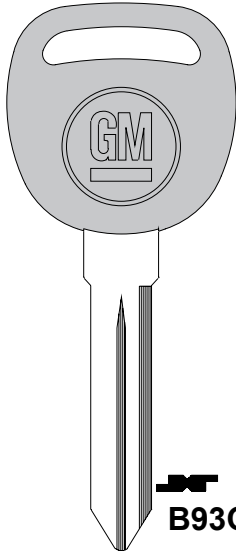

B93GP

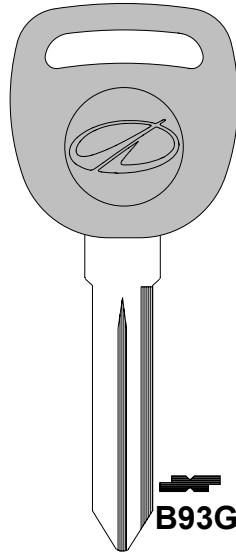

B93GOP

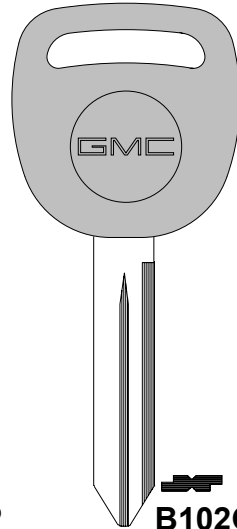

B102GP

ILCO

GM

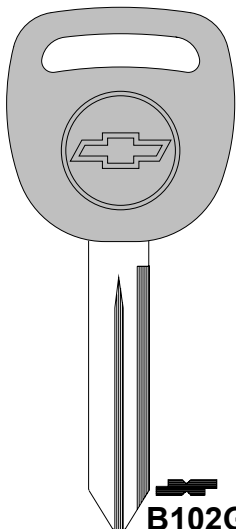

B102GCP

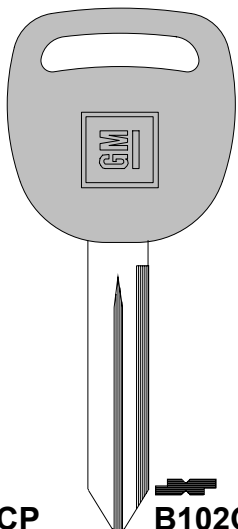

B102GMP

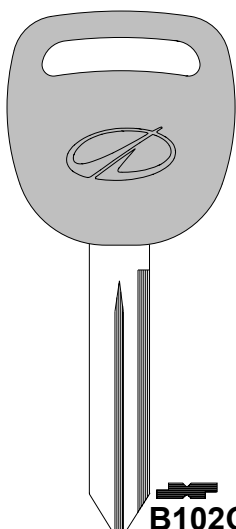

B102GOP

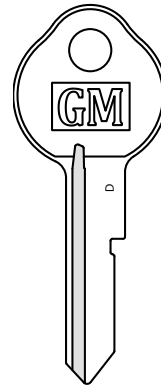

O1098D-GM

ILCO

AMERICAN LOCK

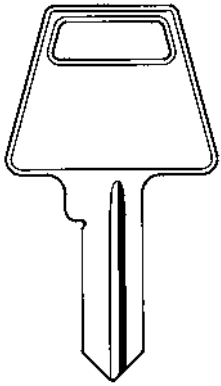

PTKB1

Orig.
No.

ARROW

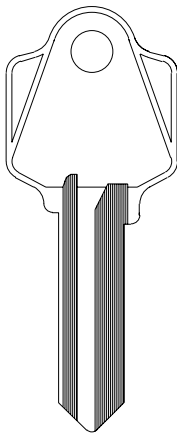

K2-A

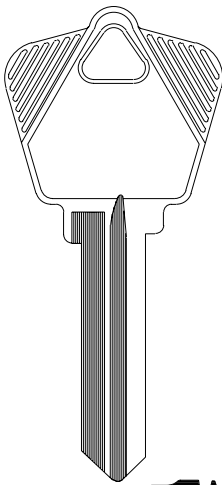

**K7
NICKEL SILVER**

BEST

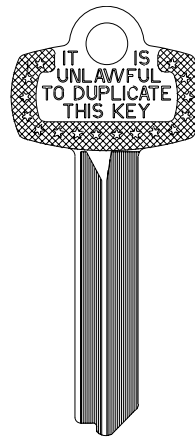

**1A1A1
NICKEL SILVER**



1A1B1



1A1C1



1A1D1



1A1DD1



1A1E1



1A1F1



1A1G1



1A1H1



1A1J1



1A1K1



1A1L1



1A1M1



1A1N1



1A1Q1



1A1R1



1A1FM1



LOOK-ALIKE CYLINDERS

BEST

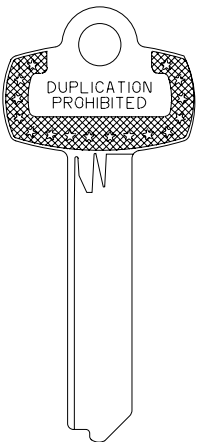

1A1TA1

Orig.
No. NICKEL SILVER



1A1TB1



1A1TC1



1A1TD1



1A1TE1

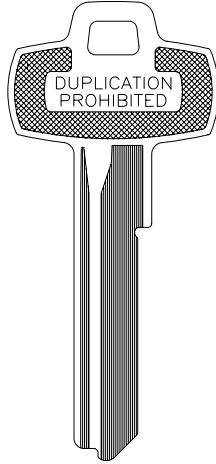

**1A1WA1
NICKEL SILVER**



1A1WB1



1A1WD1



1A1WG1



1A1WY1



1A1WC1



1A1WE1



1A1WH1

CHICAGO

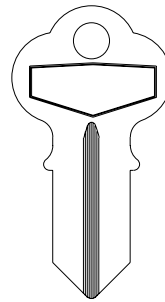

K4

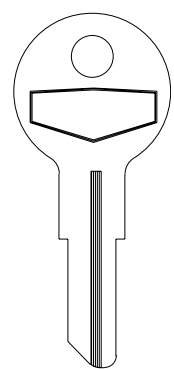

K5

CORBIN (Now Corbin/Russwin)

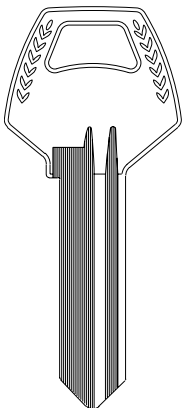

Orig. **Z1-59A1-6**
No. NICKEL SILVER

Z1-59A2-6

Z1-59B1-6

Z1-59C1-6

Z1-59C2-6

Z1-59D2-6

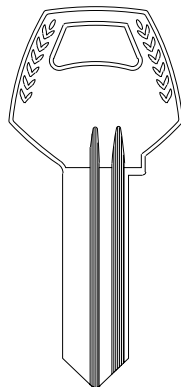

**Z1-60-5
NICKEL SILVER**

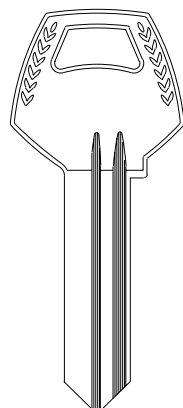

**Z1-60-6
NICKEL SILVER**

DEXTER/MASTER

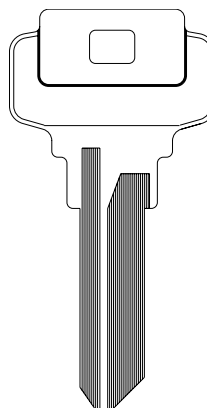

67

DOMINION

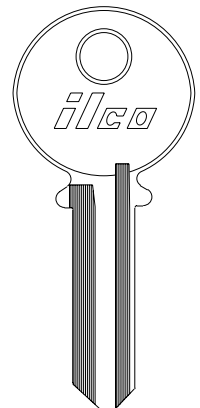

S54F





LOOK ALIKE CYLINDERS



SEC 4B
PG 308

FALCON

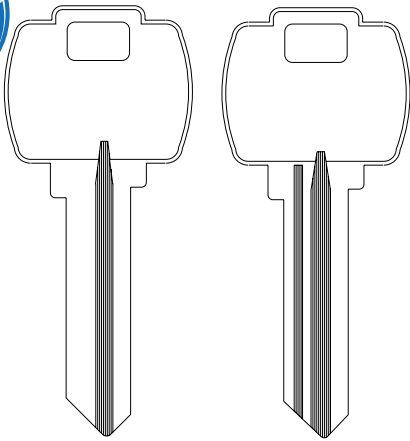

P1577E
NICKEL SILVER
KB1577G
NICKEL SILVER

HUDSON

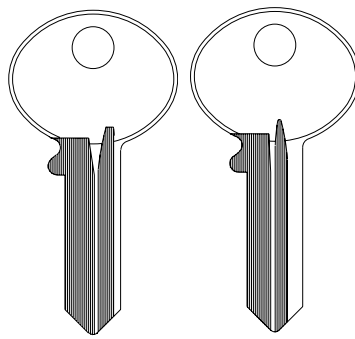

H20
H21

KWIKSET

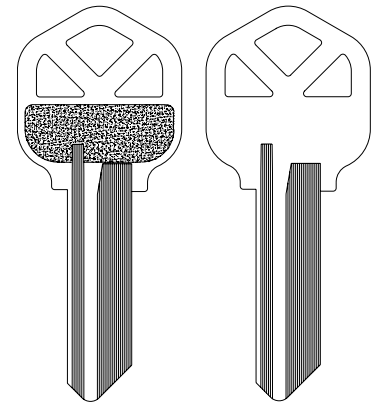

1063KW
1063KW-BR Orig. No.

KWIKSET

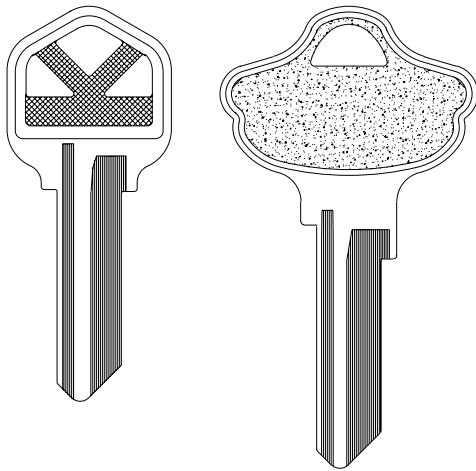

N1063KW
07743

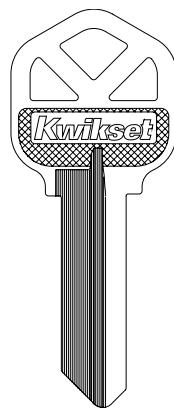

10119-001

KWIKSET/TITAN

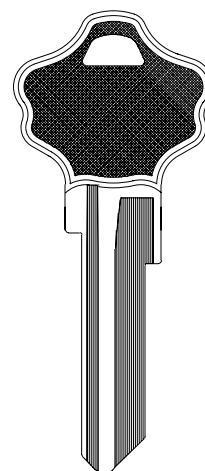

08260KW

LOCKWOOD

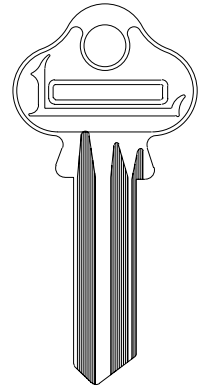

B308 Orig. No.

LOCKWOOD

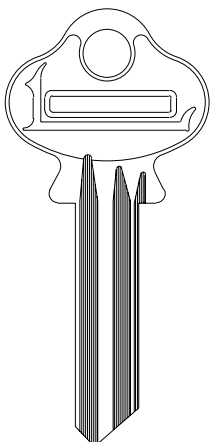

B310

MASTER

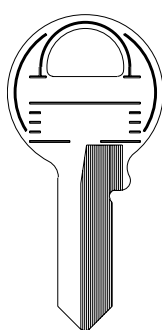

1K

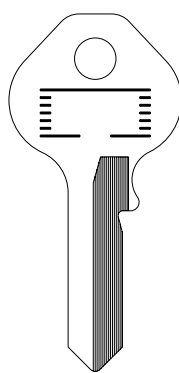

15K

MEDECO * (Compatible)

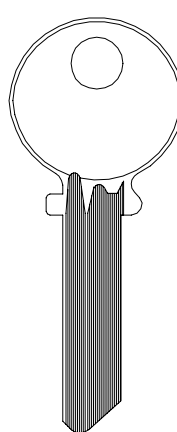

1515
NICKEL SILVER

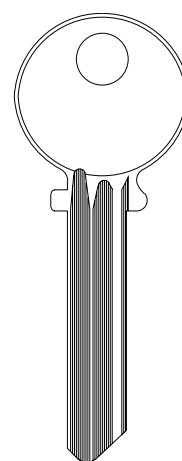

A1515
NICKEL SILVER

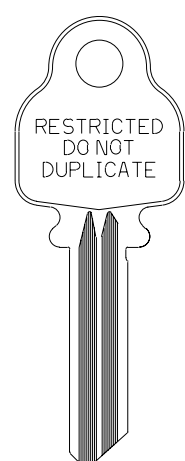

1517 Orig. No.
NICKEL SILVER

*Medeco is a trademark of a third party not affiliated or linked with Kaba Ilco or the Dormakaba Group.



MEDECO * (Compatible)

NATIONAL/AMEROCK

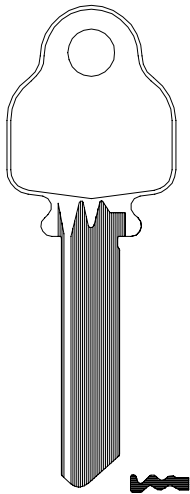

Orig. A1517
No. NICKEL SILVER

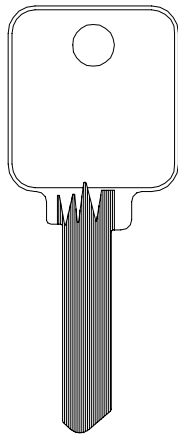

1518
NICKEL SILVER

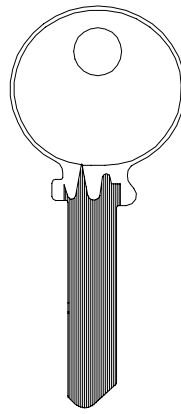

1542
NICKEL SILVER

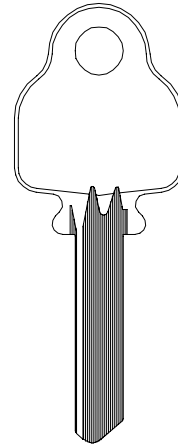

1543
NICKEL SILVER

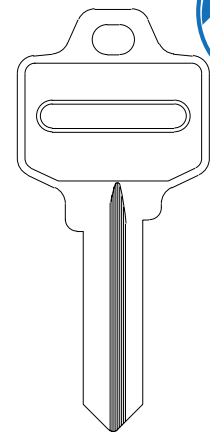

4295

RUSSWIN

SARGENT * (Compatible)

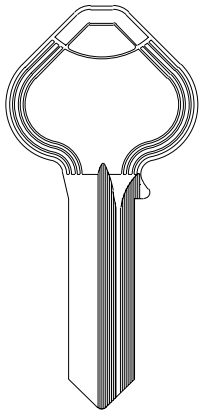

Orig. 5D1R
No. NICKEL SILVER

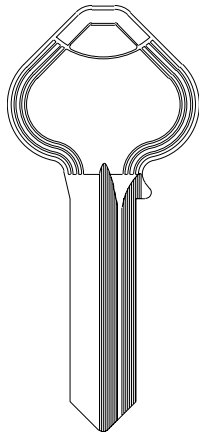

6D1R
NICKEL SILVER

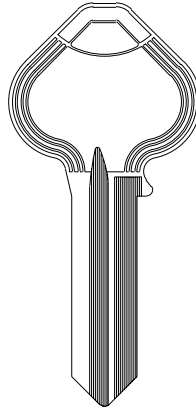

5981R
NICKEL SILVER

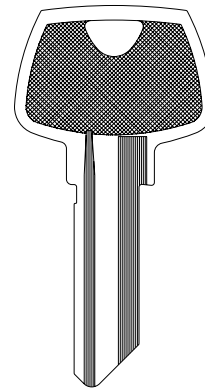

275S
NICKEL SILVER

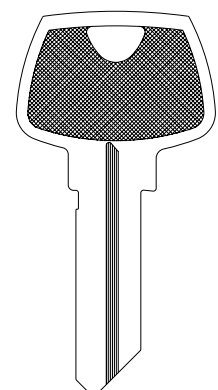

275LA
NICKEL SILVER

SARGENT * (Compatible) SCHLAGE

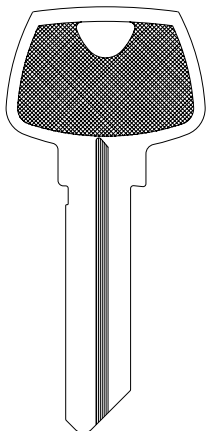

Orig. 6275LA
No. NICKEL SILVER

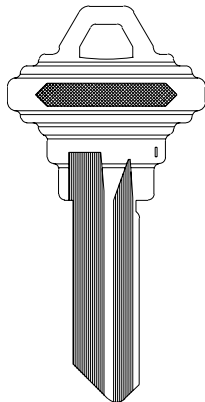

100-C
100C-NS

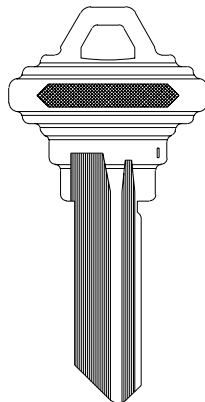

100-E
100E-NS

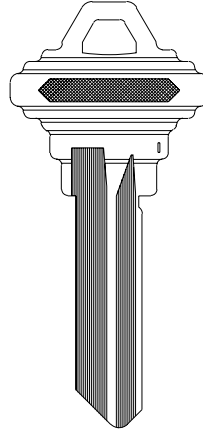

101-C
101C-NS

101-E
101E-NS
101CE-NS
101EF-NS



*Medeco and Sargent are trademarks of a third party not affiliated or linked with Kaba Ilco or the Dormakaba Group.

LOOK-ALIKE CYLINDERS



LOOK ALIKE CYLINDERS

SCHLAGE

SEGAL

TITAN

VIRO

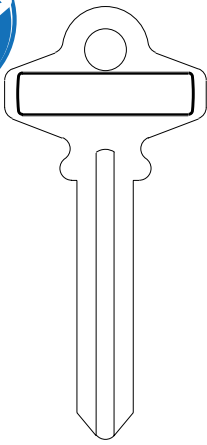

180A

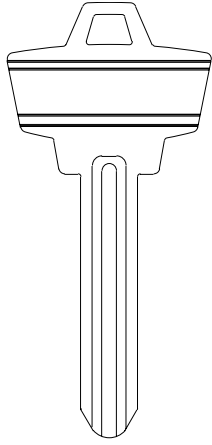

200W

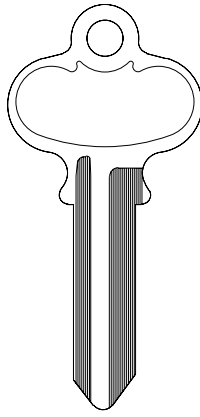

K9

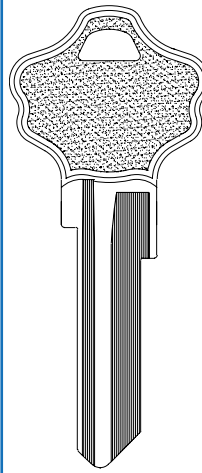

83559

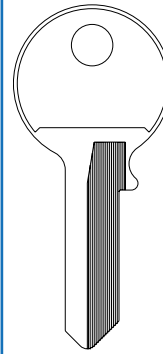

13D

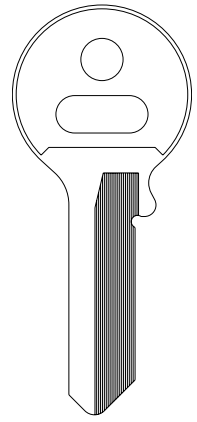

15D

Orig. No.

WEISER

WESLOCK

YALE

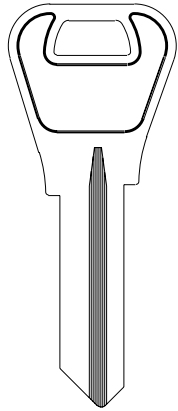

1555
1555-NS

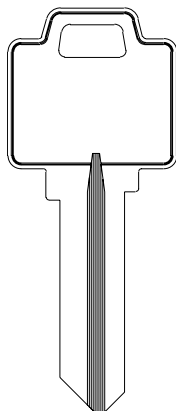

P1555
P1555-NS

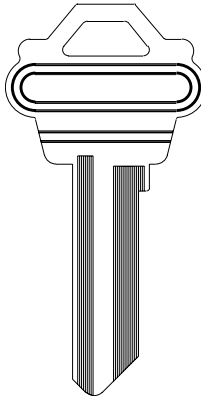

12344
12344-NS

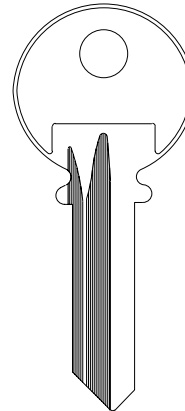

8
8-YALE-NS

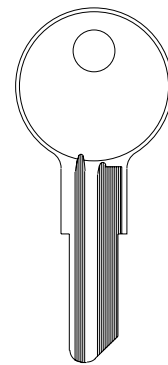

9114

Orig. No.

YALE *

AMERICAN MOTORS

CHRYSLER

FORD

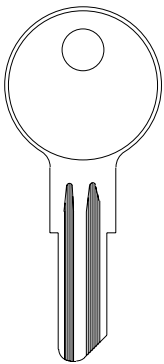

9278

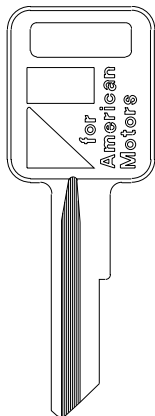

320560

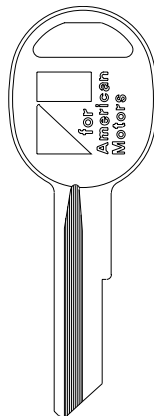

320561

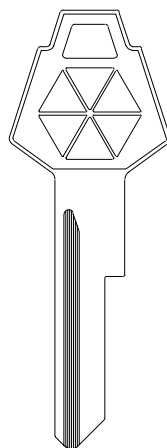

320514

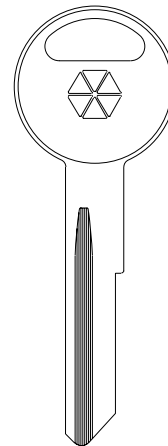

320433

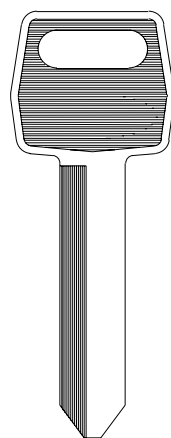

00113

Orig. No.

SEC 4B
PG 310

*Yale is a trademark of a third party not affiliated or linked with Kaba Ilco or the Dormakaba Group.



FORD

GENERAL MOTORS

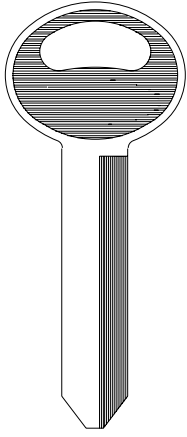

00114

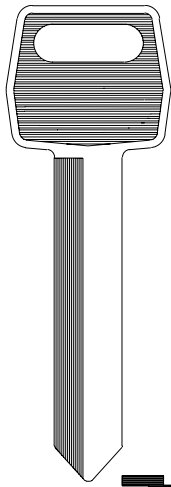

00116

Orig.
No.

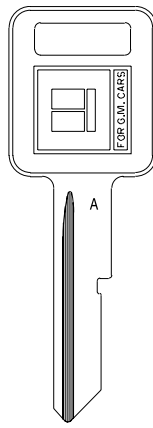

GM-A

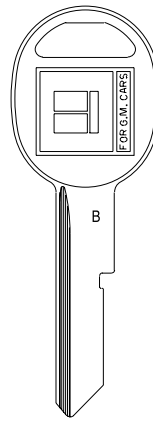

GM-B

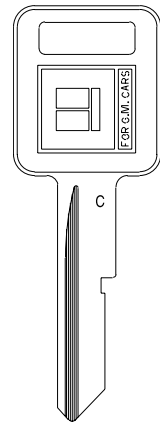

GM-C

GENERAL MOTORS

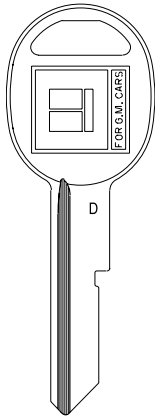

GM-D

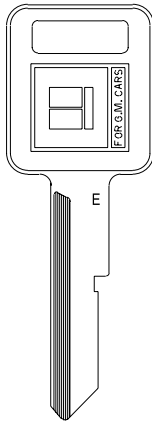

GM-E

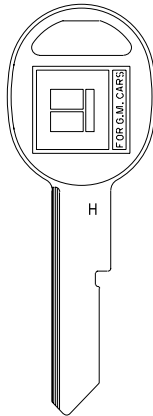

GM-H

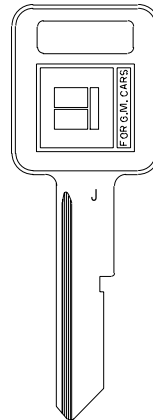

GM-J

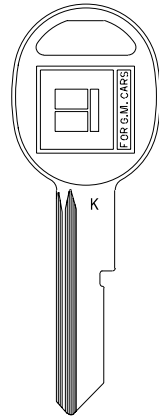

GM-K

Orig.
No.

LOOK-ALIKE CYLINDERS

Orig.
No.





ACURA



FLIP-ACURA-3B1



FLIP-ACURA-4B1

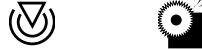

FLIP-ACURA-4B2

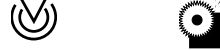

FLIP-ACURA-4B3



ILCO

LOOK-ALIKE REMOTES

ACURA



FLIP-HON-3B2



RHK-HON-4B6



RKE-ACURA-3B1



RKE-ACURA-3B2

ILCO

ACURA



RKE-ACURA-4B1



RKE-ACURA-4B2



RKE-HON-4B1



RKE-HON-4B5

ILCO

BMW



ILCO PRX-BMW-3B1
 



PRX-BMW-3B3
 



PRX-BMW-4B1
 



PRX-BMW-4B2
 

BMW



ILCO PRX-BMW-4B3
 



PRX-BMW-4B4
 



RHK-BMW-3B1
 



RHK-BMW-3B2
 

CHRYSLER



ILCO POD-LAL-3B1





POD-LAL-4B1



POD-LAL-4B2



POD-LAL-5B1



LOOK-ALIKE REMOTES





CHRYSLER



POD-LAL-5B2



POD-LAL-5B9



POD-LAL-6B1



POD-LAL-6B4



ILCO

CHRYSLER



POD-LAL-7B1



POD-LAL-7B2



PRX-CHRY-3B2



PRX-CHRY-3B4



ILCO

CHRYSLER



PRX-CHRY-4B6



PRX-CHRY-5B3



PRX-CHRY-5B5



PRX-CHRY-6B1



ILCO



LOOK-ALIKE REMOTES



CHRYSLER



ILCO PRX-CHRY-6B2



ILCO PRX-CHRY-7B1



ILCO RHK-CHRY-3B1



ILCO RHK-CHRY-3B3

CHRYSLER



ILCO RHK-CHRY-4B1



ILCO RHK-CHRY-4B2



ILCO RHK-CHRY-4B3

CHRYSLER



ILCO RHK-CHRY-4B4



ILCO RHK-CHRY-4B5



ILCO RHK-CHRY-5B1

LOOK-ALIKE REMOTES



CHRYSLER



RHK-CHRY-5B2
Ⓜ



RHK-CHRY-6B1
Ⓜ



RKE-CHRY-3B1



RKE-CHRY-4B1 ILCO

LOOK-ALIKE REMOTES

CHRYSLER

DODGE



RKE-CHRY-4B2



POD-LAL-3B1
Ⓜ



POD-LAL-3B4
Ⓜ



POD-LAL-4B1 ILCO
Ⓜ

DODGE



POD-LAL-4B2
Ⓜ



POD-LAL-4B6
Ⓜ



POD-LAL-4B8
Ⓜ



POD-LAL-4B9 ILCO
Ⓜ

DODGE



ILCO **POD-LAL-5B1**

ILCO **POD-LAL-5B2**

ILCO **POD-LAL-5B6**

ILCO **POD-LAL-5B9**

DODGE



ILCO **POD-LAL-6B1**

ILCO **POD-LAL-6B4**

ILCO **POD-LAL-7B1**

ILCO **POD-LAL-7B2**

DODGE



ILCO **PRX-CHRY-3B3**

ILCO **PRX-CHRY-3B4**

ILCO **PRX-CHRY-4B4**

ILCO **PRX-CHRY-4B5**



LOOK-ALIKE REMOTES





DODGE



PRX-CHRY-4B6



PRX-CHRY-5B4



PRX-CHRY-5B5



RHK-CHRY-3B1 ILCO



LOOK-ALIKE REMOTES

DODGE



RHK-CHRY-3B2



RHK-CHRY-3B3



RHK-CHRY-4B1

ILCO



DODGE



RHK-CHRY-4B2



RHK-CHRY-4B3



RHK-CHRY-4B5

ILCO



DODGE



ILCO RHK-CHRY-5B1

RHK-CHRY-5B2

RHK-CHRY-6B1

DODGE



ILCO RKE-CHRY-3B1

RKE-CHRY-3B2

RKE-CHRY-4B1

RKE-CHRY-4B2

FIAT

FORD



ILCO FLIP-FIAT-3B1

FLIP-FIAT-3B2

FLIP-FORD-3B1HS

FLIP-FORD-4B2HS



LOOK-ALIKE REMOTES





FORD



FLIP-FORD-4B3HS



PRX-FORD-3B2

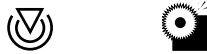

PRX-FORD-3B3



PRX-FORD-4B2



ILCO

LOOK-ALIKE REMOTES

FORD

GENERAL MOTORS



PRX-FORD-4B3



PRX-FORD-4B4



PRX-FORD-5B2



PRX-FORD-5B4



ILCO

FORD



PRX-FORD-5B5



PRX-FORD-5B6



PRX-FORD-5B7



PRX-FORD-5B8



ILCO

SEC 4C
PG 320



FORD



ILCO PRX-FORD-5B9
 



RHK-FORD-3B1



RHK-FORD-3B3HS
 

FORD



ILCO RHK-FORD-3B4
 



RHK-FORD-3B5



RHK-FORD-3B6HS
 

FORD



ILCO RHK-FORD-3B7HS
 



RHK-FORD-4B1HS
 



RHK-FORD-4B2

LOOK-ALIKE REMOTES





FORD



RHK-FORD-4B3



RHK-FORD-4B4



RHK-FORD-5B1



ILCO

FORD



RKE-FORD-3B1



RKE-FORD-4B1



RKE-FORD-4B2

ILCO

FORD

GENERAL MOTORS



RKE-FORD-5B1



RKE-FORD-5B3



FLIP-GM-3B1HS



FLIP-GM-4B1HS



ILCO

LOOK-ALIKE REMOTES

SEC 4C
PG 322



GENERAL MOTORS



ILCO FLIP-GM-4B2HS
 

FLIP-GM-4B3HS
 

FLIP-GM-4B4HS
 

FLIP-GM-5B1HS
 

GENERAL MOTORS



ILCO FLIP-GM-5B2HS
 

PRX-BUICK-3B1

PRX-BUICK-3B2



PRX-BUICK-4B1



GENERAL MOTORS



ILCO PRX-BUICK-4B2

PRX-BUICK-5B1

PRX-BUICK-5B2

PRX-BUICK-5B3

LOOK-ALIKE REMOTES



GENERAL MOTORS



PRX-CAD-3B1



PRX-CAD-3B2



PRX-CAD-4B1



PRX-CAD-4B2 ILCO



LOOK-ALIKE REMOTES

GENERAL MOTORS



PRX-CAD-4B3



PRX-CAD-5B1



PRX-CAD-5B2



PRX-CAD-5B3 ILCO



GENERAL MOTORS



PRX-CAD-5B4



PRX-CAD-5B5



PRX-CAD-6B1



PRX-CAD-6B2 ILCO



GENERAL MOTORS



ILCO PRX-CHEVY-3B1

PRX-CHEVY-3B2

PRX-CHEVY-4B1

PRX-CHEVY-4B2

GENERAL MOTORS



ILCO PRX-CHEVY-5B1

PRX-CHEVY-5B2

PRX-CHEVY-5B3

PRX-CHEVY-5B4

GENERAL MOTORS



ILCO PRX-CHEVY-5B5

PRX-CHEVY-6B1

PRX-GM-3B1

PRX-GM-3B2

LOOK-ALIKE REMOTES



GENERAL MOTORS



PRX-GM-4B1



PRX-GM-4B3



PRX-GM-4B4



PRX-GM-5B1

ILCO

LOOK-ALIKE REMOTES

GENERAL MOTORS



PRX-GM-5B6



PRX-GM-5B7



PRX-GM-6B2



RKE-CAD-4B1

ILCO

GENERAL MOTORS



RKE-CAD-4B2



RKE-CAD-5B2



RKE-CAD-6B1



RKE-GM-3B1

ILCO

SEC 4C
PG 326

GENERAL MOTORS



ILCO

RKE-GM-3B2



RKE-GM-3B3



RKE-GM-3B4

GENERAL MOTORS



ILCO

RKE-GM-3B5



RKE-GM-3B6



RKE-GM-3B7

GENERAL MOTORS



ILCO

RKE-GM-3B8



RKE-GM-3B9



RKE-GM-4B1



LOOK-ALIKE REMOTES





GENERAL MOTORS



RKE-GM-4B10



RKE-GM-4B11



RKE-GM-4B12

ILCO

LOOK-ALIKE REMOTES

GENERAL MOTORS



RKE-GM-4B13



RKE-GM-4B14



RKE-GM-4B15

ILCO

GENERAL MOTORS



RKE-GM-4B16



RKE-GM-4B17



RKE-GM-4B18

ILCO

GENERAL MOTORS



ILCO RKE-GM-4B19



RKE-GM-4B2



RKE-GM-4B20

GENERAL MOTORS



ILCO RKE-GM-4B21



RKE-GM-4B22



RKE-GM-4B3

GENERAL MOTORS



ILCO RKE-GM-4B4



RKE-GM-4B5



RKE-GM-4B6



LOOK-ALIKE REMOTES





GENERAL MOTORS



RKE-GM-4B7



RKE-GM-4B8



RKE-GM-4B9

ILCO

LOOK-ALIKE REMOTES

GENERAL MOTORS



RKE-GM-5B1



RKE-GM-5B2



RKE-GM-5B3

ILCO

GENERAL MOTORS



RKE-GM-5B4



RKE-GM-5B5



RKE-GM-5B6

ILCO

GENERAL MOTORS



ILCO

RKE-GM-5B7



RKE-GM-6B1



RKE-GM-6B2



LOOK-ALIKE REMOTES



SEC 4C
PG 331

GENERAL MOTORS



ILCO

RKE-GM-6B3



RKE-TOY-3B3



RKE-TOY-4B6

HONDA



ILCO

RHK-HON-3B1



RHK-HON-3B2



RHK-HON-3B4



RHK-HON-3B5





HONDA



RHK-HON-3B6



RHK-HON-3B7



RHK-HON-3B8



RHK-HON-4B1



ILCO

HONDA



RHK-HON-4B10



RHK-HON-4B2



RHK-HON-4B3



RHK-HON-4B4



ILCO

HONDA



RHK-HON-4B6



RHK-HON-4B7



RHK-HON-4B8



RHK-HON-4B9



ILCO



LOOK-ALIKE REMOTES



HONDA



ILCO RHK-HON-5B1
 

RHK-HON-6B1
 

RKE-HON-3B1

RKE-HON-3B2

HONDA



ILCO RKE-HON-3B3

RKE-HON-3B4

RKE-HON-4B1

RKE-HON-4B2

HONDA



ILCO RKE-HON-4B3

RKE-HON-4B4

RKE-HON-5B1

RKE-HON-6B1



LOOK-ALIKE REMOTES





HYUNDAI



FLIP-HYUN-4B3



FLIP-HYUN-4B4



PRX-HYUN-4B2



PRX-HYUN-4B3



ILCO

HYUNDAI



PRX-HYUN-4B4



RKE-HYUN-3B1



RKE-HYUN-3B2



RKE-HYUN-3B3

ILCO

HYUNDAI

INFINITI



RKE-HYUN-4B1



RKE-HYUN-4B2



PRX-INF-4B1



PRX-INF-4B2



ILCO

LOOK-ALIKE REMOTES

INFINITI



ILCO PRX-INF-5B1



PRX-NIS-4B1



RHK-NIS-4B2



RKE-NIS-3B1

INFINITI

JAGUAR

JEEP



ILCO RKE-NIS-4B1



FLIP-JAG-4B1
 



POD-LAL-3B1



POD-LAL-3B3

JEEP



ILCO POD-LAL-3B4



POD-LAL-4B3



POD-LAL-4B7



POD-LAL-4B9

LOOK-ALIKE REMOTES



JEEP



POD-LAL-4B10



POD-LAL-5B3



POD-LAL-5B4



POD-LAL-5B7



ILCO

JEEP



POD-LAL-5B8



POD-LAL-6B2



POD-LAL-6B3



PRX-CHRY-3B3



ILCO

JEEP



PRX-CHRY-4B4



PRX-CHRY-4B5



PRX-CHRY-5B4



PRX-JEEP-3B1



ILCO

LOOK-ALIKE REMOTES

JEEP



ILCO PRX-JEEP-3B2 

PRX-JEEP-3B3 

PRX-JEEP-4B1 

PRX-JEEP-4B2 

JEEP



ILCO PRX-JEEP-4B3 

PRX-JEEP-4B4 

PRX-JEEP-4B5 

PRX-JEEP-5B1 

JEEP



ILCO RHK-CHRY-3B1 

RHK-CHRY-4B1 

RHK-CHRY-4B2 



LOOK-ALIKE REMOTES





JEEP



RHK-CHRY-4B4



RHK-CHRY-4B5



RHK-CHRY-5B1



ILCO

JEEP



RHK-CHRY-5B2



RKE-CHRY-4B1



RKE-JEEP-3B1

ILCO

KIA



FLIP-KIA-3B1



FLIP-KIA-3B2



FLIP-KIA-3B3



FLIP-KIA-4B3



ILCO



LOOK-ALIKE REMOTES



KIA



ILCO FLIP-KIA-4B4  

FLIP-KIA-4B5  

FLIP-KIA-4B6  

FLIP-KIA-4B7  

KIA



ILCO PRX-HYUN-4B2  

PRX-HYUN-4B3  

RKE-KIA-3B1

RKE-KIA-4B1

LEXUS



ILCO PRX-LEX-3B1  

PRX-LEX-4B2  

PRX-LEX-4B3  

PRX-LEX-4B4  



LOOK-ALIKE REMOTES





LEXUS



PRX-LEX-4B5



PRX-LEX-4B6



RHK-LEXUS-3B1



ILCO

LEXUS



RHK-LEXUS-3B2



RHK-LEXUS-3B3



RHK-LEXUS-3B4



RHK-LEXUS-3B5



ILCO

LEXUS



RHK-LEXUS-3B6



RHK-LEXUS-3B7



RHK-LEXUS-3B8



RHK-LEXUS-3B9 ILCO



LOOK-ALIKE REMOTES



SEC 4C
PG 340

LINCOLN



ILCO PRX-FORD-4B4
 

PRX-FORD-5B2

PRX-FORD-5B5
 

PRX-FORD-5B6
 

LINCOLN



ILCO PRX-FORD-5B8
 

RHK-FORD-4B2

RHK-FORD-4B3

RHK-FORD-4B4

LINCOLN



ILCO RHK-FORD-5B1

RKE-FORD-4B1

RKE-FORD-4B2

RKE-FORD-5B1

LOOK-ALIKE REMOTES



LINCOLN

MAZDA



RKE-FORD-5B2



RKE-FORD-5B3



FLIP-MAZ-3B1



FLIP-MAZ-3B2



ILCO

LOOK-ALIKE REMOTES

MAZDA



FLIP-MAZ-4B1



FLIP-MAZ-4B2



RKE-MAZ-3B1



RKE-MAZ-3B2

ILCO

MAZDA

MERCURY



RKE-MAZ-4B1



RKE-MAZ-4B2



RHK-FORD-3B1



ILCO

MERCURY



ILCO RHK-FORD-4B2



RKE-FORD-4B4



RKE-FORD-4B1

MERCURY

MITSUBISHI



ILCO RKE-FORD-4B2



RKE-FORD-5B3



RHK-CHRY-3B2

MITSUBISHI



ILCO RHK-MITS-3B1



RHK-MITS-3B2



RHK-MITS-4B1

LOOK-ALIKE REMOTES



MITSUBISHI



RHK-MITS-4B2



RKE-MITS-2B1



RHK-MITS-2B2



RKE-MITS-2B3

ILCO

LOOK-ALIKE REMOTES

MITSUBISHI



RKE-MITS-3B1



RKE-MITS-3B2



RKE-MITS-3B3



RKE-MITS-4B1

ILCO

NISSAN



FLIP-NIS-3B2



PRX-NIS-3B2



PRX-NIS-3B3



PRX-NIS-3B4



ILCO

NISSAN



ILCO PRX-NIS-3B5



PRX-NIS-3B6



PRX-NIS-4B1



PRX-NIS-4B10

NISSAN



ILCO PRX-NIS-4B11



PRX-NIS-4B12



PRX-NIS-4B2



PRX-NIS-4B3

NISSAN



ILCO PRX-NIS-4B7



PRX-NIS-4B8



PRX-NIS-4B9



PRX-NIS-5B3



LOOK-ALIKE REMOTES





NISSAN



PRX-NIS-5B4



PRX-NIS-5B5



PRX-NIS-5B6



PRX-NIS-5B7



ILCO

NISSAN



PRX-NIS-5B8



PRX-NIS-5B9



PRX-NIS-5B10



RHK-NIS-3B1



ILCO

NISSAN



RHK-NIS-4B2



RKE-NIS-3B1



RKE-NIS-4B1



RKE-NIS-5B1

ILCO

LOOK-ALIKE REMOTES



NISSAN

PLYMOUTH

RAM



ILCO RKE-NIS-6B1

RKE-CHRY-3B1

RHK-CHRY-4B2

FLIP-PROMASTER-3B1



RAM



ILCO FLIP-PROMASTERCITY-3B1

POD-LAL-3B1

POD-LAL-3B2

POD-LAL-4B2



RAM



ILCO POD-LAL-4B4

POD-LAL-4B5

POD-LAL-5B5

PRX-RAM-3B1



LOOK-ALIKE REMOTES





RAM



PRX-RAM-4B1



PRX-RAM-5B1



RHK-CHRY-3B1

ILCO

LOOK-ALIKE REMOTES

RAM



RHK-CHRY-3B2



RHK-CHRY-4B1



RHK-CHRY-4B5

ILCO

RAM

SCION

SUBARU



RKE-CHRY-3B1



RKE-CHRY-3B2



RKE-TOY-3B4



RHK-SUB-4B1

ILCO

SUBARU



ILCO RHK-SUB-4B2
 



RHK-SUB-4B3



RHK-SUB-4B4



RHK-SUB-4B5

SUBARU



ILCO RHK-SUB-4B6HS
 



RKE-SUB-2B1



RKE-SUB-4B1



RKE-SUB-4B2

TOYOTA





ILCO FLIP-TOY-3B1
 



FLIP-TOY-4B1
 



PRX-TOY-3B2
 



PRX-TOY-3B3
 

LOOK-ALIKE REMOTES



TOYOTA



PRX-TOY-3B4



PRX-TOY-3B5



PRX-TOY-3B6



PRX-TOY-3B7

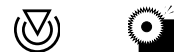

ILCO

TOYOTA



PRX-TOY-3B8



PRX-TOY-3B9



PRX-TOY-3B10



PRX-TOY-4B2

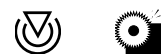

ILCO

TOYOTA



PRX-TOY-4B3



PRX-TOY-4B4

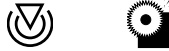

PRX-TOY-4B5



PRX-TOY-4B6



ILCO

SEC 4C
PG 350



LOOK-ALIKE REMOTES

TOYOTA



ILCO PRX-TOY-4B7
 

PRX-TOY-4B8
 

PRX-TOY-4B9
 

PRX-TOY-4B10
 

TOYOTA



ILCO PRX-TOY-4B11
 

PRX-TOY-4B12
 

RHK-TOY-3BD1

RHK-TOY-3BD2

TOYOTA



ILCO RHK-TOY-3BD3

RHK-TOY-3BFJ

RHK-TOY-3BFJ2

LOOK-ALIKE REMOTES



TOYOTA



RHK-TOY-3BG1



RHK-TOY-3BG2



RHK-TOY-3BG3



ILCO

TOYOTA



RHK-TOY-3BH



RHK-TOY-3BH2



RHK-TOY-3BH3



ILCO

TOYOTA



RHK-TOY-3BLC



RHK-TOY-3BPC



RHK-TOY-4B1



ILCO



LOOK-ALIKE REMOTES



TOYOTA



ILCO RHK-TOY-4BD
▽



RHK-TOY-4BD2
▽



RHK-TOY-4BG
▽

TOYOTA



ILCO RHK-TOY-4BG2
▽



RHK-TOY-4BH
▽



RHK-TOY-4BH2
▽

TOYOTA



ILCO RHK-TOY-4BH3
▽



RKE-TOY-3B1



RKE-TOY-3B2



LOOK-ALIKE REMOTES





TOYOTA



RKE-TOY-3B3



RKE-TOY-3B4



RKE-TOY-4B1



RKE-TOY-4B2

ILCO

LOOK-ALIKE REMOTES

TOYOTA



RKE-TOY-4B3



RKE-TOY-4B4



RKE-TOY-4B5



RKE-TOY-4B6

ILCO

TOYOTA

VOLKSWAGEN



RKE-TOY-5B1



RKE-TOY-6B1



FLIP-VW-4B1



POD-LAL-3B1

ILCO



ILCO **POD-LAL-5B2**

POD-LAL-6B1

POD-LAL-7B1

RSK-VW-4B1

LOOK-ALIKE REMOTES

ILCO

ILCO





SECTION 5 SAFE DEPOSIT

Worldwide safe deposit keys. Organized by lock manufacturer in alphabetical order with the keys listed in numerical order. Flat keys with no milling do not show a key profile in this section.



DIEBOLD

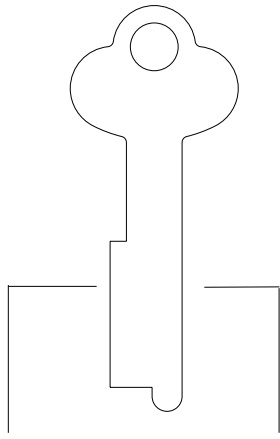

.055" - 1.4mm
.375" - 9.5mm
1028

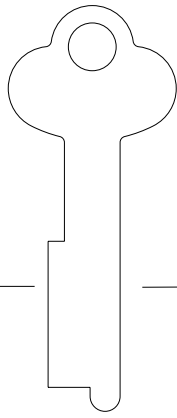

.050" - 1.3mm
.375" - 9.5mm
1028L

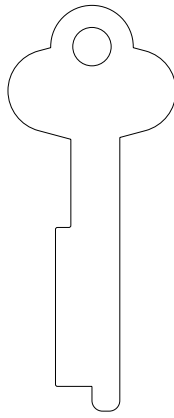

.055" - 1.4mm
.340" - 8.6mm
1028DD

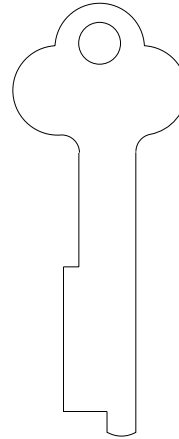

.050" - 1.3mm
.375" - 9.5mm
1028E

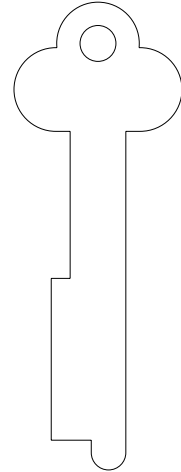

.055" - 1.4mm
.390" - 9.9mm
1028F

**THICK
WIDTH
ILCO**

SAFE DEPOSIT

DIEBOLD

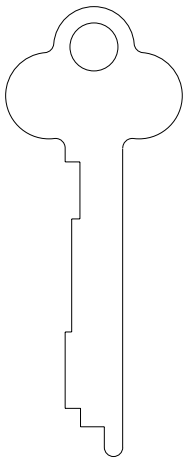

.060" - 1.5mm
.300" - 7.6mm
1028P

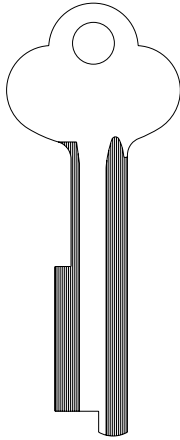

.075" - 1.9mm
.375" - 9.5mm
1052A

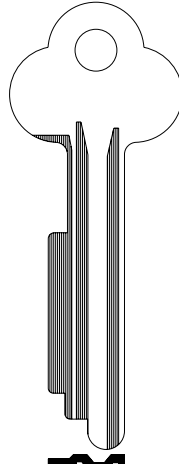

.085" - 2.2mm
.390" - 9.9mm
1052B

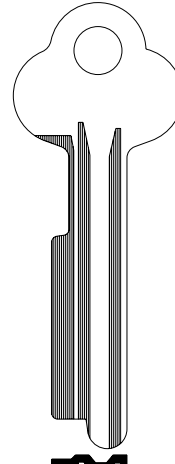

.085" - 2.2mm
.390" - 9.9mm
1052C

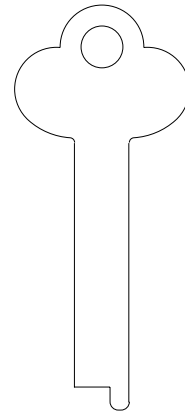

.050" - 1.3mm
.285" - 7.2mm
1066

**THICK
WIDTH
ILCO**

DIEBOLD

HHM / YORK

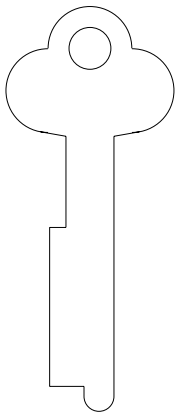

.050" - 1.3mm
.340" - 8.5mm
1365

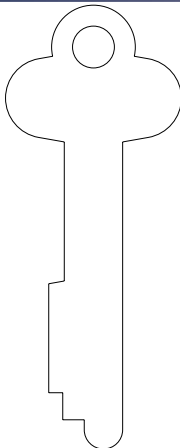

.050" - 1.3mm
.385" - 9.8mm
1028A

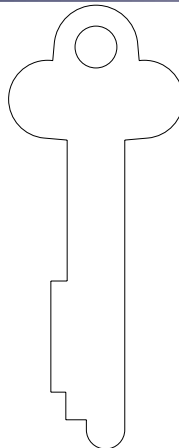

.055" - 1.4mm
.385" - 9.8mm
1028AY

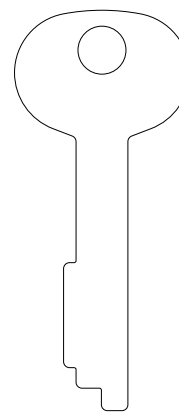

.060" - 1.5mm
.335" - 8.5mm
1028G

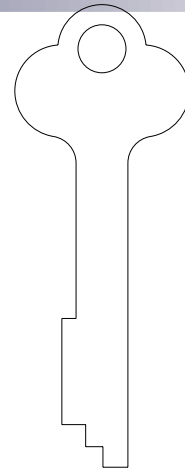

.060" - 1.5mm
.335" - 8.5mm
1028N

**THICK
WIDTH
ILCO**

SEC 5
PG 358

HHM/YORK

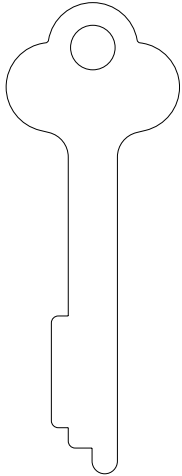

THICK
WIDTH
ILCO
1028NN

.060" - 1.5mm
.340" - 8.6mm

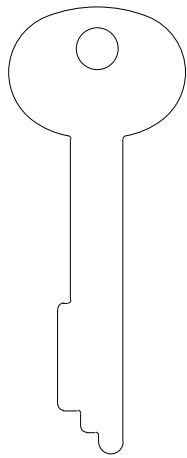

THICK
WIDTH
ILCO
O1028AH

.060" - 1.5mm
.340" - 8.6mm

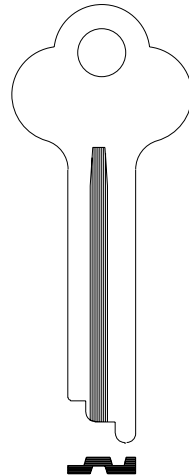

THICK
WIDTH
ILCO
1133

.085" - 2.2mm
.350" - 8.9mm

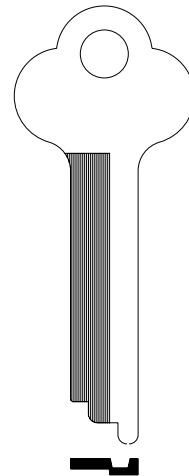

THICK
WIDTH
ILCO
1133A

.085" - 2.2mm
.350" - 8.9mm

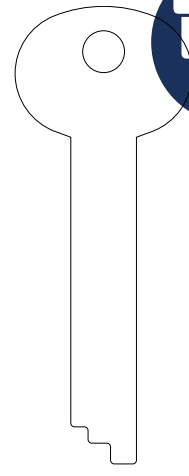

THICK
WIDTH
ILCO
1134

.085" - 2.2mm
.350" - 8.9mm



SAFE DEPOSIT



HHM/YORK

ILCO/KABA MAS

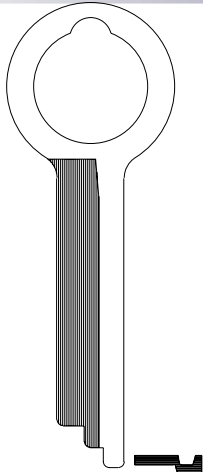

THICK
WIDTH
ILCO
1135

.080" - 2.0mm
.350" - 8.9mm

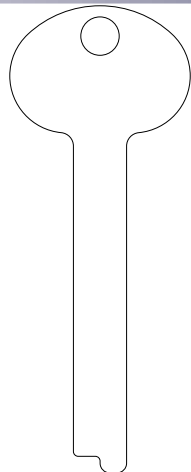

THICK
WIDTH
ILCO
SG4

.080" - 2.0mm
.280" - 7.1mm

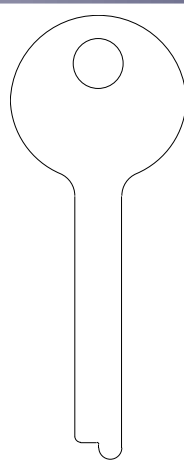

THICK
WIDTH
ILCO
887

.060" - 1.5mm
.240" - 6.1mm

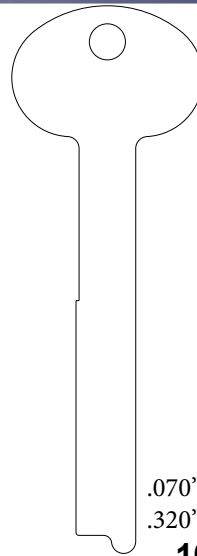

THICK
WIDTH
ILCO
1089C

.070" - 1.8mm
.320" - 8.1mm

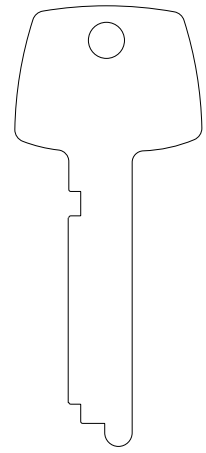

THICK
WIDTH
ILCO
1333

.070" - 1.8mm
.330" - 8.4mm

ILCO/KABA MAS

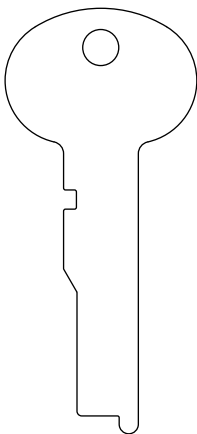

THICK
WIDTH
ILCO
1334

.070" - 1.8mm
.320" - 8.1mm

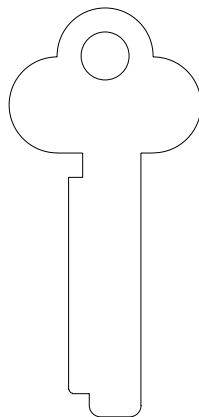

THICK
WIDTH
ILCO
1335S

.080" - 2.2mm
.375" - 9.5mm

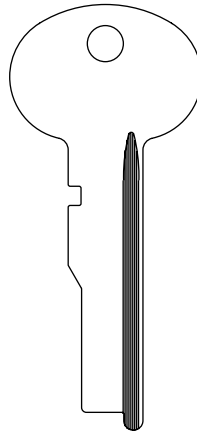

THICK
WIDTH
ILCO
1360G

.085" - 2.2mm
.320" - 8.1mm

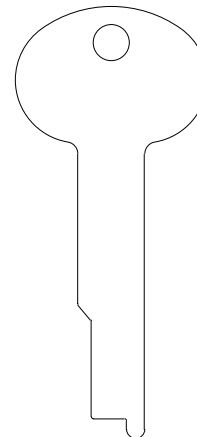

THICK
WIDTH
ILCO
1362

.070" - 1.8mm
.280" - 7.1mm

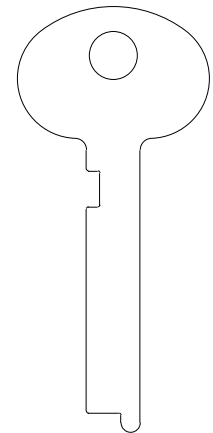

THICK
WIDTH
ILCO
1387

.080" - 2.0mm
.280" - 7.1mm



ILCO/KABA MAS

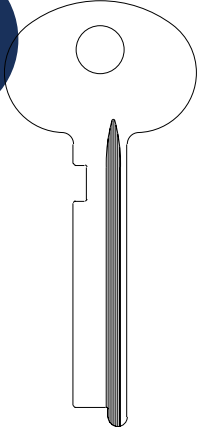

.080" - 2.0mm
.280" - 7.1mm
1387G

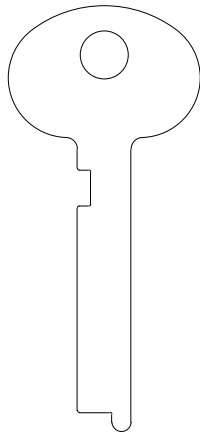

.070" - 1.8mm
.280" - 7.1mm
1388

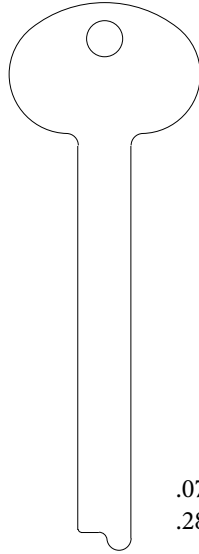

.070" - 1.8mm
.280" - 7.1mm
1388L

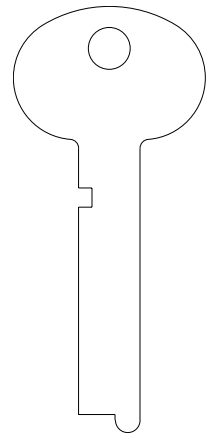

.070" - 1.8mm
.320" - 8.1mm
1396S

THICK
WIDTH
ILCO

SAFE DEPOSIT

ILCO/KABA MAS

LEFEBURE

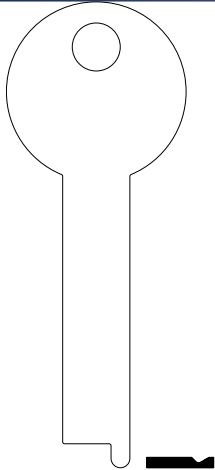

.055" - 1.4mm
.350" - 8.9mm
1526

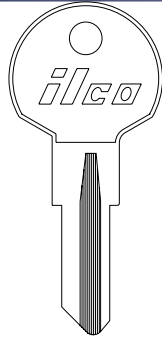

1054UN

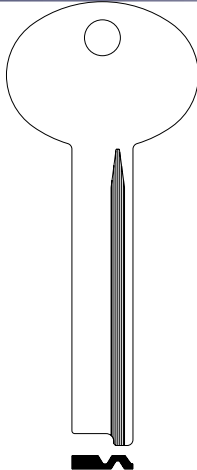

.070" - 1.8mm
.320" - 8.1mm
LB1

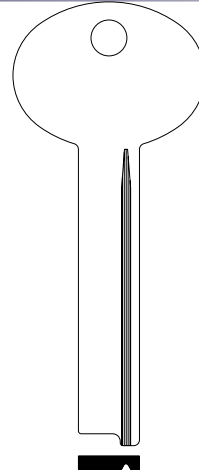

.070" - 1.8mm
.320" - 8.1mm
LB2

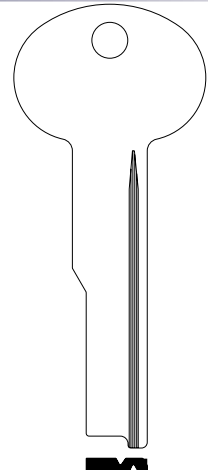

.070" - 1.8mm
.320" - 8.1mm
LB3

THICK
WIDTH
ILCO

LEFEBURE

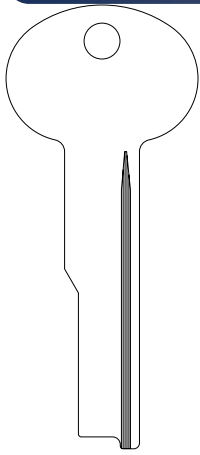

.070" - 1.8mm
.320" - 8.1mm
LB4

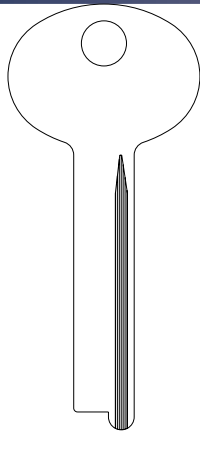

.070" - 1.8mm
.320" - 8.1mm
LB5

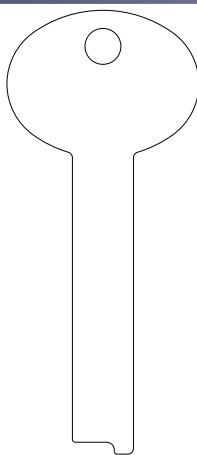

.080" - 2.0mm
.320" - 8.1mm
LB6

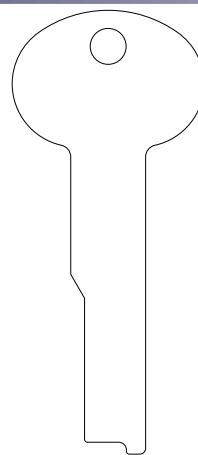

.070" - 1.8mm
.320" - 8.1mm
LB7

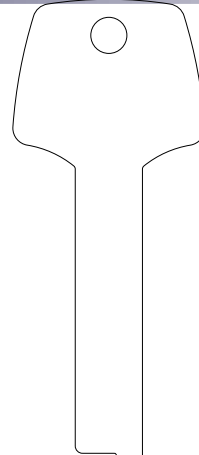

.070" - 1.8mm
.350" - 8.9mm
LB8

THICK
WIDTH
ILCO

MILES OSBORNE

MOSLER

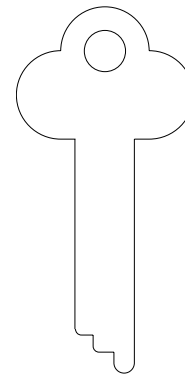
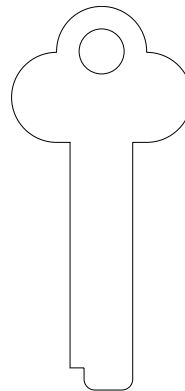
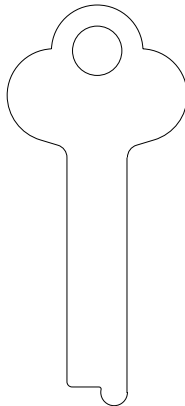
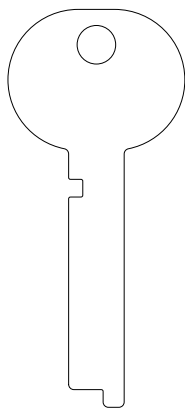
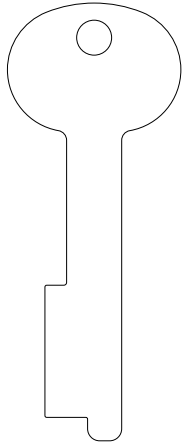

THICK .081" - 2.1mm
 WIDTH .435" - 11.0mm
 ILCO **MN1**

.050" - 1.3mm
 .315" - 8.0mm
MN3

.040" - 1.0mm
 .305" - 7.7mm
143D

.080" - 2.0mm
 .350" - 8.9mm
155

.060" - 1.5mm
 .330" - 8.49mm
706

MOSLER

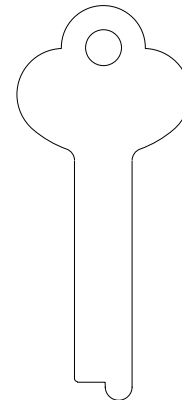
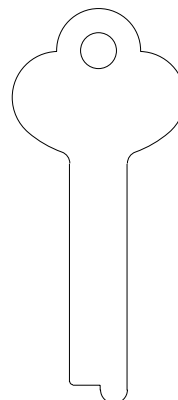
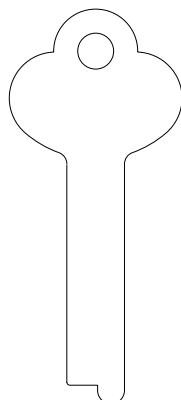
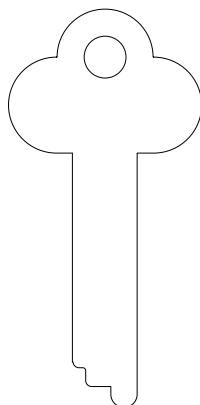
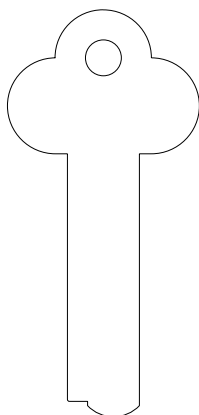

THICK .060" - 1.5mm
 WIDTH .375" - 9.5mm
 ILCO **723**

.060" - 1.5mm
 .335" - 8.5mm
1091

.040" - 1.0mm
 .300" - 7.6mm
1095

.050" - 1.3mm
 .300" - 7.6mm
1095HL

.060" - 1.5mm
 .300" - 7.6mm
1095H

MOSLER

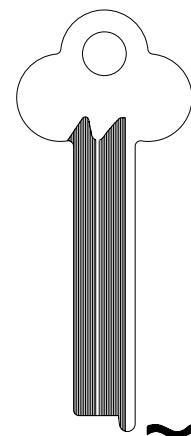
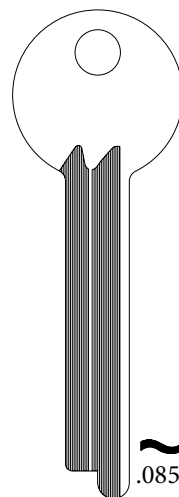
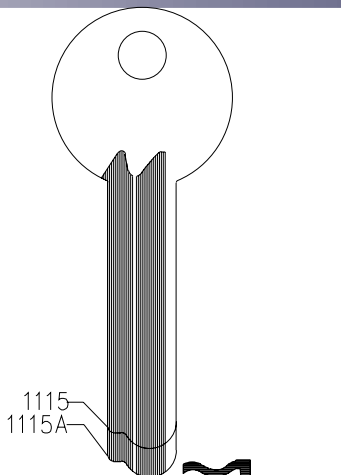
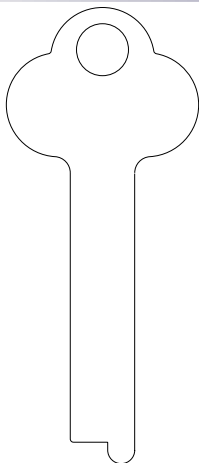

THICK .040" - 1.0mm
 WIDTH .300" - 7.6mm
 ILCO **1095A**

.085" - 2.2mm
 .350" - 8.9mm
1115

.085" - 2.2mm
 .350" - 8.91mm
1115A

.085" - 2.2mm
 .355" - 9.0mm
1115AL

.085" - 2.2mm
 .350" - 8.9mm
1115B



SAFE DEPOSIT





MOSLER



.085" - 2.2mm
.350" - 8.9mm
1115BL

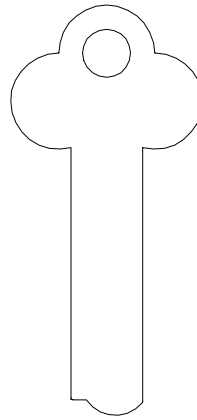

.060" - 1.5mm
.380" - 9.7mm
1323

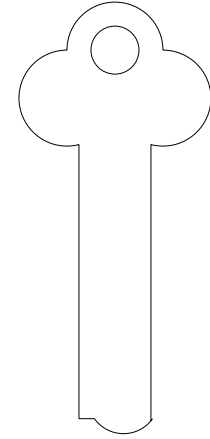

.060" - 1.5mm
.380" - 9.7mm
1323L

THICK
WIDTH
ILCO

SAFE DEPOSIT

MOSLER

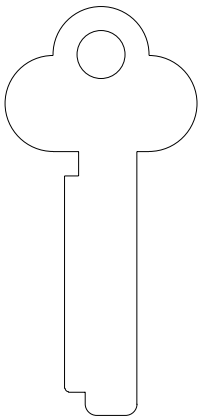

.060" - 1.5mm
.375" - 9.5mm
1335S

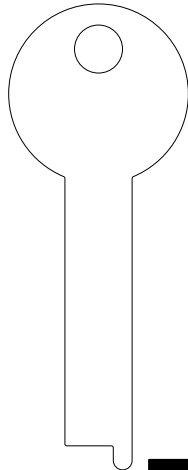

.055" - 1.4mm
.350" - 8.9mm
1526

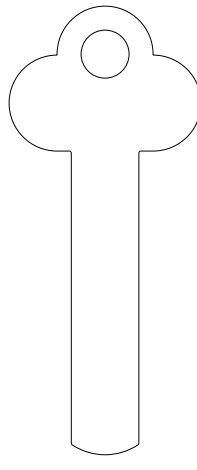

.060" - 1.5mm
.350" - 8.9mm
4015

PRECISION

SEE ILCO/
KABA MAS

S & G

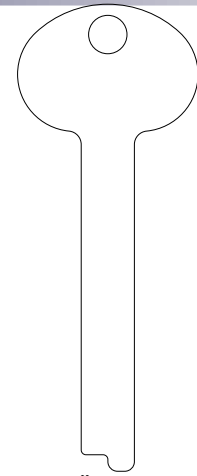

.080" - 2.0mm
.280" - 7.1mm
SG4

THICK
WIDTH
ILCO

SARGENT & GREENLEAF / S & G

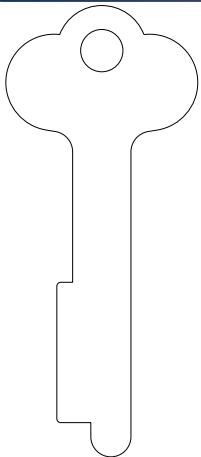

.050" - 1.8mm
.375" - 9.5mm
1028D

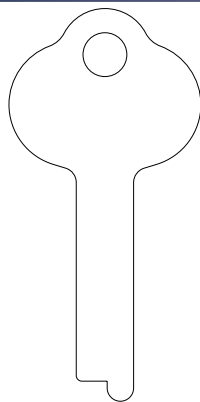

.060" - 1.5mm
.280" - 7.1mm
1063

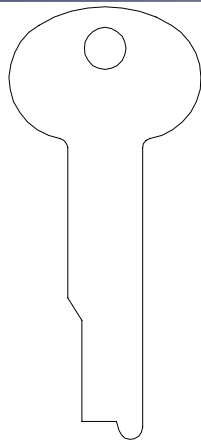

.070" - 1.8mm
.375" - 9.5mm
1063B

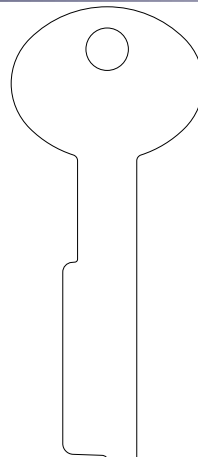

.070" - 1.8mm
.380" - 9.7mm
1063D

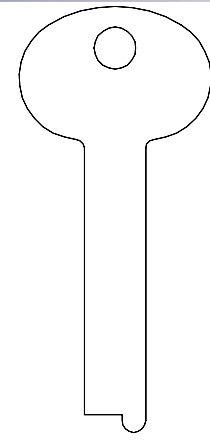

.070" - 1.8mm
.320" - 8.1mm
1063E

THICK
WIDTH
ILCO

SARGENT & GREENLEAF / S & G

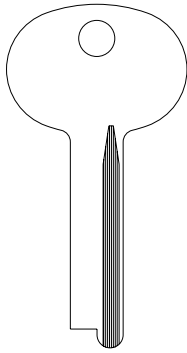

THICK
WIDTH
ILCO

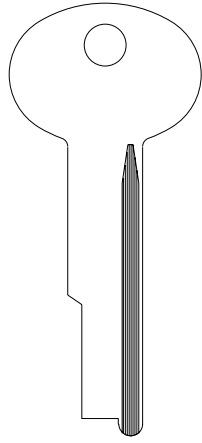
.085" - 2.2mm
.275" - 7.0mm
1068



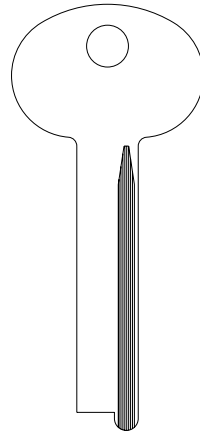

.085" - 2.2mm
.320" - 8.1mm
1068B



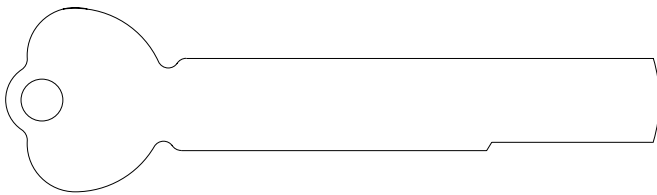

.085" - 2.2mm
.320" - 8.1mm
1068E

SARGENT & GREENLEAF / S & G

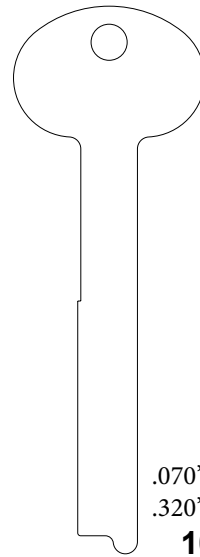

THICK
WIDTH
ILCO
.050" - 1.3mm
.435" - 11.2mm
1084



.070" - 1.8mm
.320" - 8.1mm
1089C

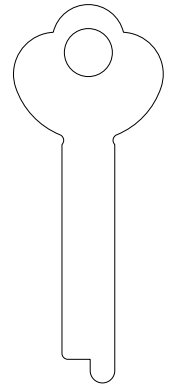

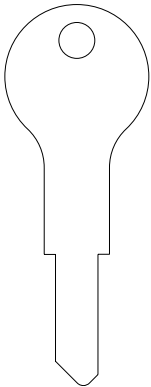

.050" - 1.3mm
.275" - 7.0mm
A1124

SARGENT & GREENLEAF / S & G

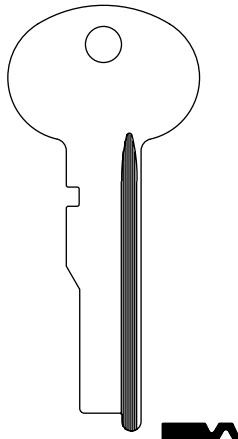

THICK
WIDTH
ILCO
.075" - 1.9mm
.215" - 5.5mm
O1125NR



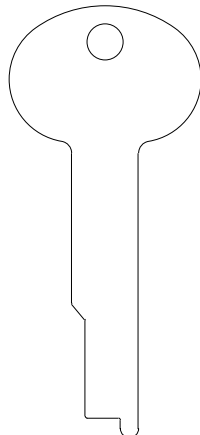

.085" - 2.2mm
.320" - 8.1mm
1360G

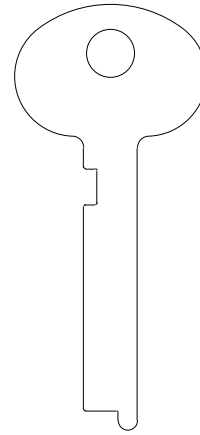

.070" - 1.8mm
.280" - 7.1mm
1362

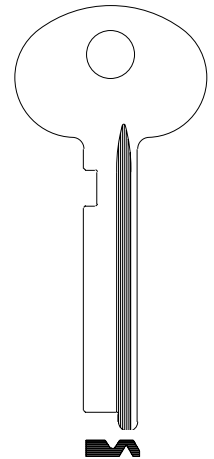

.080" - 2.0mm
.280" - 7.1mm
1387



.080" - 2.0mm
.280" - 7.1mm
1387G



SAFE DEPOSIT





SARGENT & GREENLEAF / S & G

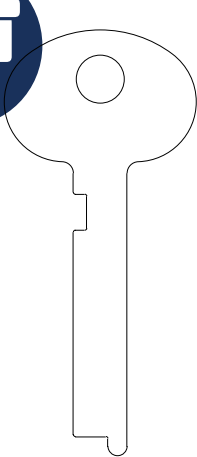

.070" - 1.8mm
.280" - 7.1mm

1388

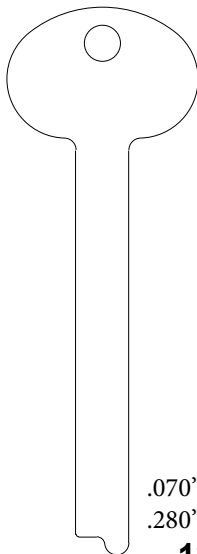

.070" - 1.8mm
.280" - 7.1mm

1388L

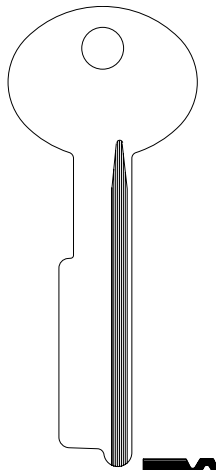

.085" - 2.2mm
.380" - 9.7mm

1389G

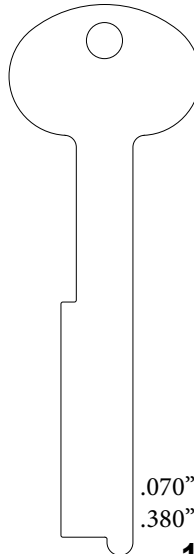

.070" - 1.8mm
.380" - 9.7mm

1390

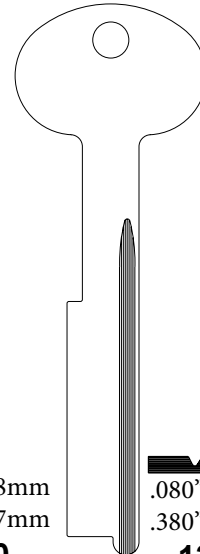

.080" - 2.0mm
.380" - 9.7mm

1390G

THICK
WIDTH
ILCO

SAFE DEPOSIT

SECURITY / KUMAHIRA

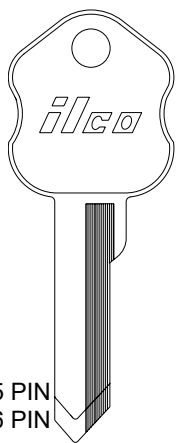

5 PIN
6 PIN

5 PIN 6 PIN
SY1 SY5-NS

SY2 SY6-NS

SY4 SY8-NS

SY7 SY7-NS

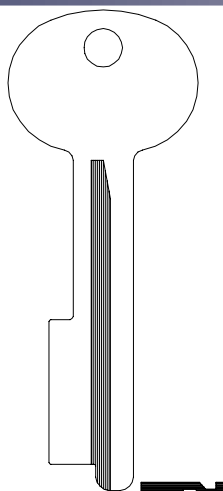

.075" - 1.9mm
.440" - 11.2mm

SY10

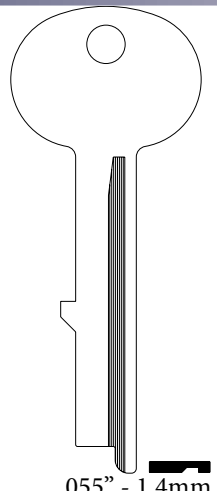

.055" - 1.4mm
.310" - 7.9mm

SY11

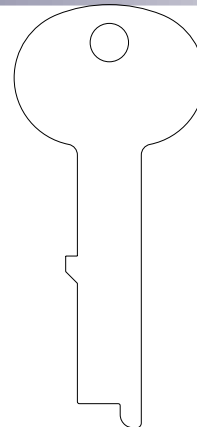

.055" - 1.4mm
.315" - 8.0mm

SY12

THICK
WIDTH
ILCO

SECURITY / KUMAHIRA YALE * (Compatible)

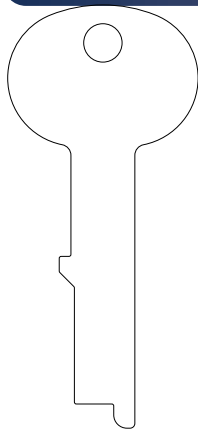

.055" - 1.4mm
.315" - 8.0mm

SY13

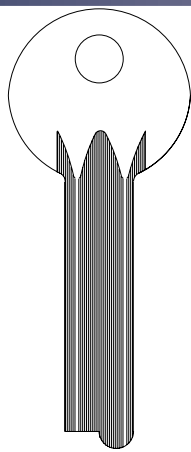

.085" - 2.2mm
.355" - 9.0mm

884

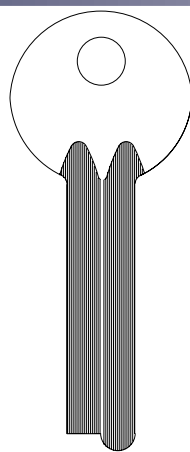

.085" - 2.2mm
.355" - 9.0mm

884R

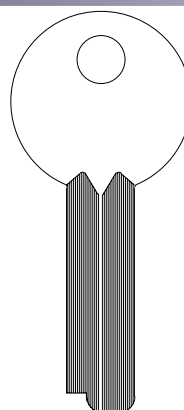

.080" - 2.0mm
.350" - 8.9mm

884BR

THICK
WIDTH
ILCO

SEC
5
PG
364

*Yale is a trademark of a third party not affiliated or linked with Kaba Ilco or the Dormakaba Group.



YALE * (Compatible)

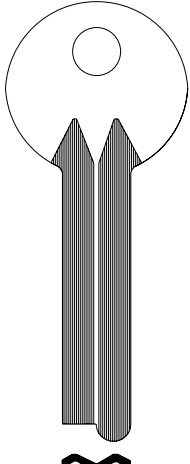

THICK .080" - 2.0mm
 WIDTH .355" - 9.0mm
 ILCO **885**

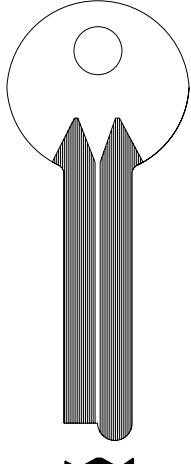

THICK .080" - 2.0mm
 WIDTH .355" - 9.0mm
 ILCO **885R**

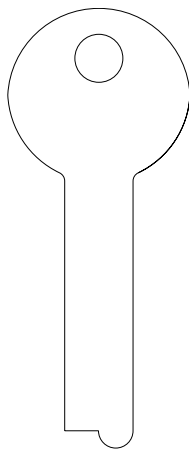

THICK .080" - 2.0mm
 WIDTH .350" - 8.9mm
 ILCO **885BL**

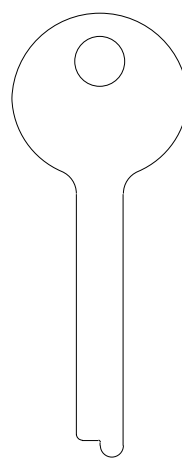

THICK .060" - 1.5mm
 WIDTH .240" - 6.1mm
 ILCO **887**

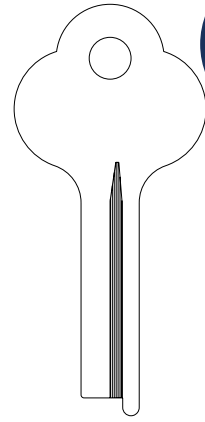

THICK .090" - 2.3mm
 WIDTH .300" - 7.6mm
 ILCO **1060C**

YALE * (Compatible) MISCELLANEOUS

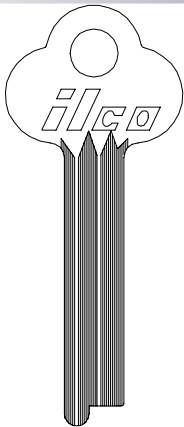

THICK .085" - 2.1mm
 WIDTH .300" - 7.6mm
 ILCO **1587**

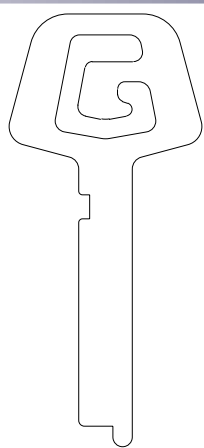

THICK .070" - 1.8mm
 WIDTH .280" - 7.1mm
 ILCO **SG5**

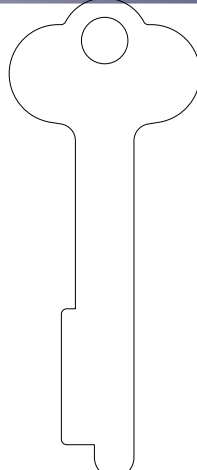

THICK .050" - 1.3mm
 WIDTH .375" - 9.5mm
 ILCO **1028C**

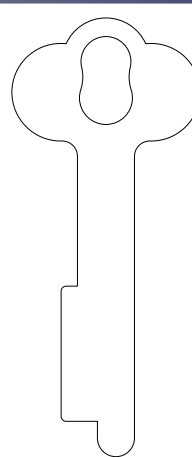

THICK .050" - 1.3mm
 WIDTH .435" - 11.2mm
 ILCO **1028DC**

MISCELLANEOUS

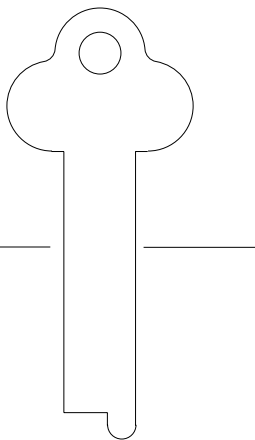

THICK .050" - 1.3mm
 WIDTH .275" - 7.0mm
 ILCO **1093**

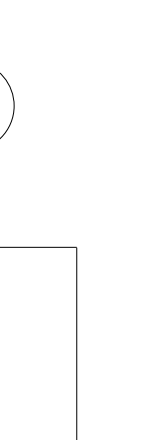

THICK .085" - 2.2mm
 WIDTH .320" - 8.1mm
 ILCO **1093H**

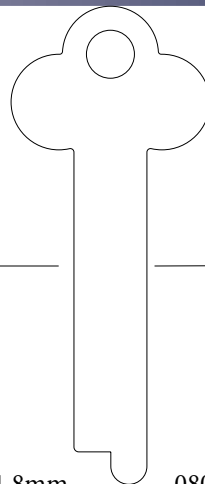

THICK .070" - 1.8mm
 WIDTH .280" - 7.1mm
 ILCO **1110A**

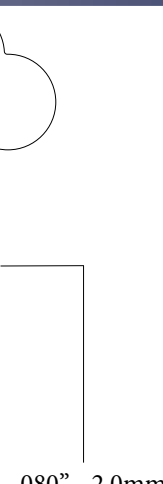

THICK .080" - 2.0mm
 WIDTH .280" - 7.1mm
 ILCO **1110B**



SAFE DEPOSIT





SECTION 6A FLAT STEEL

Worldwide flat steel keys. Organized by lock manufacturer where possible and listed in numerical order. Only keys with key way milling or corrugation are illustrated with a profile view.



SECTION 6B MISCELLANEOUS KEYS

A selection of special purpose keys organized by lock manufacturer where possible and listed in numerical sequence.



CORBIN

EAGLE

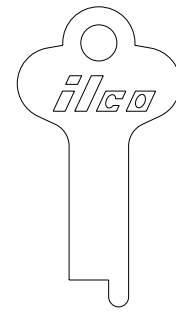
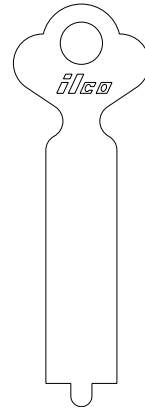

.070" - 1.8mm
.310" - 7.9mm

725

.050" - 1.3mm
.365" - 9.3mm

672

.040" - 1.0mm
.310" - 7.9mm

1214

THICK
WIDTH
ILCO

FLAT STEEL

EAGLE

LOCKWOOD AUSTRALIA

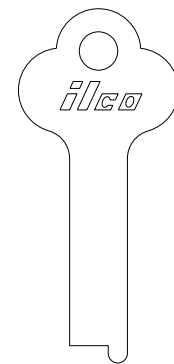
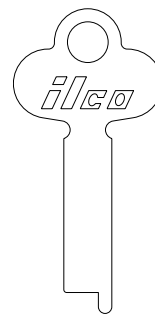
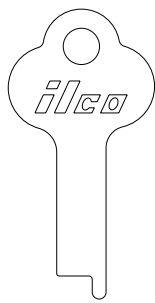
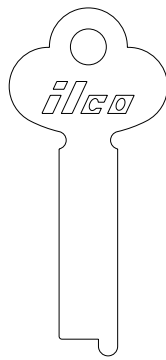
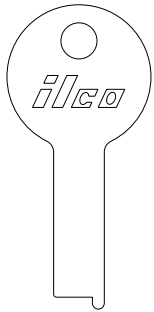

.050" - 1.3mm
.265" - 6.7mm

1270D

.060" - 1.5mm
.300" - 7.6mm

1412

.050" - 1.3mm
.260" - 6.6mm

1417

.060" - 1.5mm
.250" - 6.4mm

1417A

.065" - 1.7mm
.300" - 7.6mm

201

THICK
WIDTH
ILCO

MASTER

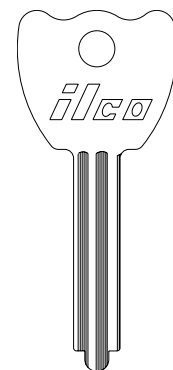
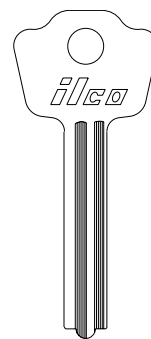
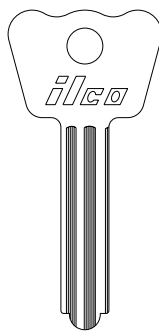
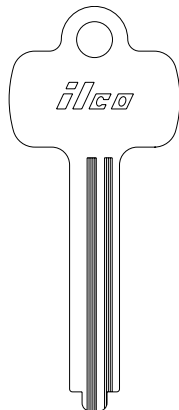
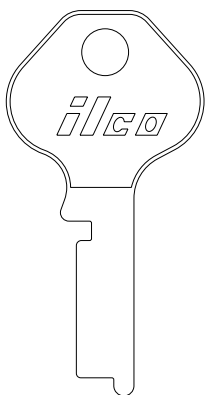

.065" - 1.7mm
.300" - 7.6mm

T153



1286



1286B



1286BR



1286C



1286E R1286E



THICK
WIDTH
ILCO

SEC
6A
PG
368



MASTER

MEDART

SLAYMAKER

SWITCH KEY

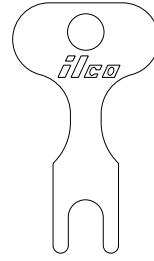
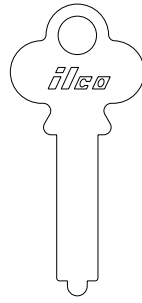
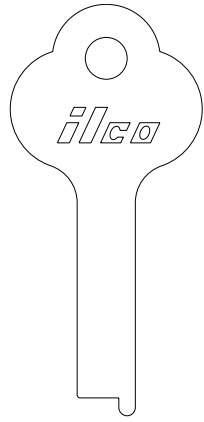
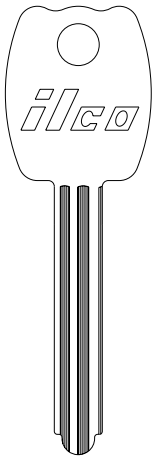

THICK WIDTH
ILCO N1286 N1286R

.060" - 1.5mm
.300" - 7.6mm
1332S

.050" - 1.3mm
.215" - 5.6mm
1418

.060" - 1.5mm
.340" - 8.7mm
1425

YALE * (Compatible)

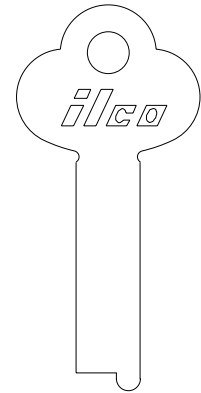
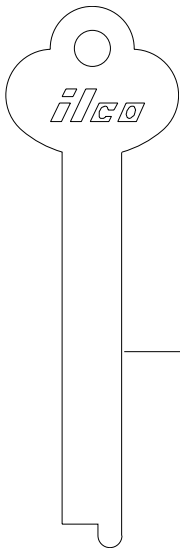

THICK WIDTH
ILCO 621A

.060" - 1.5mm
.310" - 7.9mm

.040" - 1.0mm
.310" - 7.9mm
U621A

.050" - 1.2mm
.310" - 7.9mm
1221AL

.050" - 1.2mm
.335" - 8.5mm
O1223L

YALE * (Compatible)

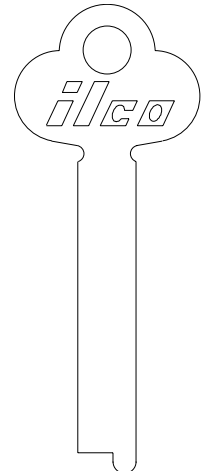
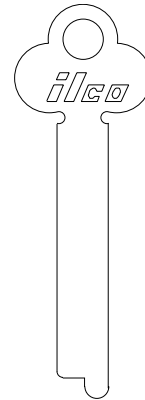
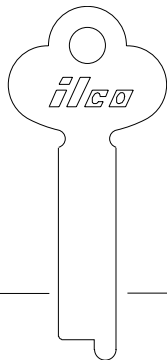

THICK WIDTH
ILCO 1224

.050" - 1.2mm
.300" - 7.6mm

.060" - 1.5mm
.300" - 7.6mm
1224F

.040" - 1.0mm
.300" - 7.6mm
1224L

.050" - 1.2mm
270" - 6.8mm
1225A

.040" - 1.0mm
.305" - 7.8mm
1225E



FLAT STEEL



*Yale is a trademark of a third party not affiliated or linked with Kaba Ilco or the Dormakaba Group.



YALE * (Compatible)

MISCELLANEOUS FLAT STEEL

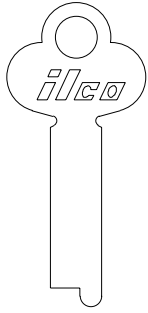

.040" - 1.0mm
.265" - 6.7mm

1225PL

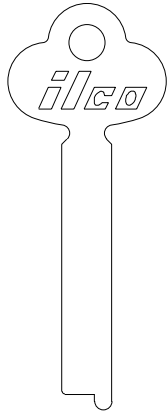

.040" - 1.0mm
.260" - 6.6mm

1422

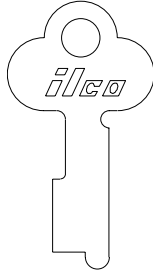

.050" - 1.3mm
.295" - 7.5mm

1427

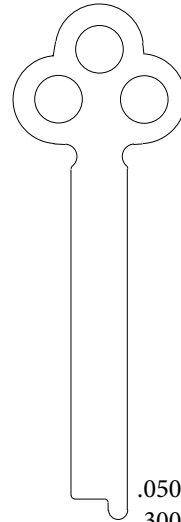

.050" - 1.2mm
.300" - 7.6mm

T45

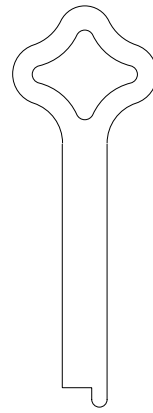

.040" - 1.0mm
.250" - 6.4mm

T64

THICK
WIDTH
ILCO

MISCELLANEOUS FLAT STEEL

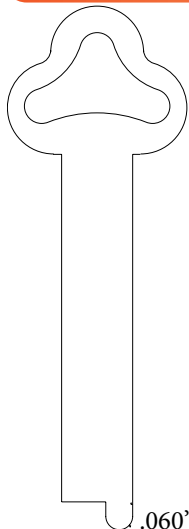

.060" - 1.5mm
.375" - 9.5mm

T70

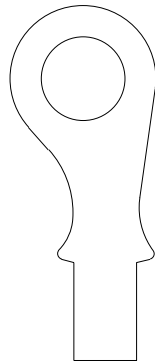

.050" - 1.2mm
.330" - 8.4mm

T131

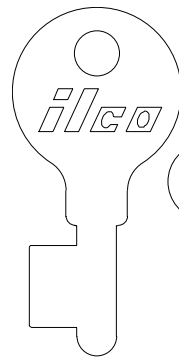

.065" - 1.7mm
.460" - 11.7mm

E375

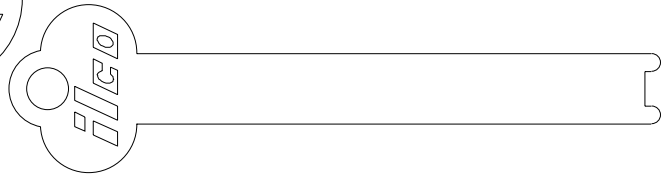

.050" - 1.2mm
.365" - 9.3mm

1206

THICK
WIDTH
ILCO

MISCELLANEOUS FLAT STEEL

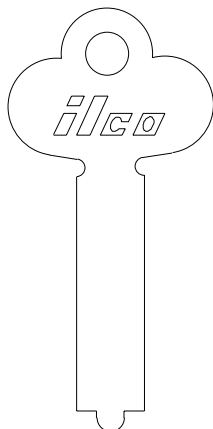

.060" - 1.5mm
.350" - 8.1mm

610B

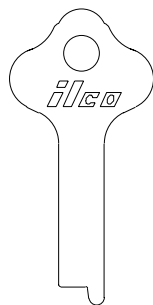

.040" - 1.0mm
.250" - 6.4mm

615

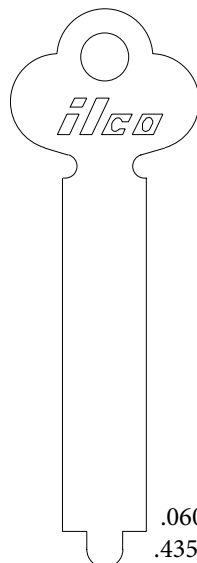

.060" - 1.5mm
.435" - 11.0mm

1209

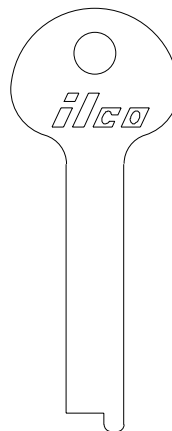

.050" - 1.2mm
.300" - 7.6mm

1213A

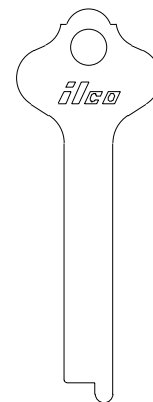

.040" - 1.0mm
.250" - 6.4mm

1215A

THICK
WIDTH
ILCO

SEC
6A
PG
370

*Yale is a trademark of a third party not affiliated or linked with Kaba Ilco or the Dormakaba Group.



FLAT STEEL

MISCELLANEOUS FLAT STEEL

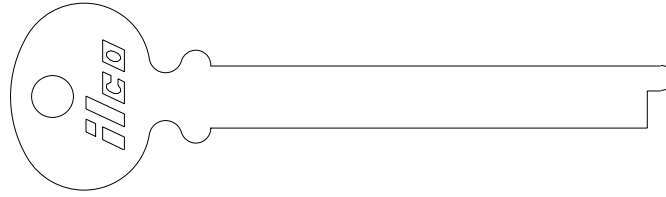
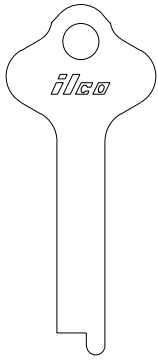

THICK .040" - 1.0mm
 WIDTH .250" - 6.4mm
 ILCO **1215B**

.050" - 1.3mm
 .325" - 8.3mm
1217A

MISCELLANEOUS FLAT STEEL

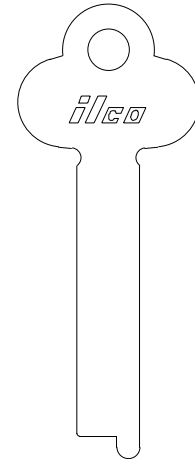
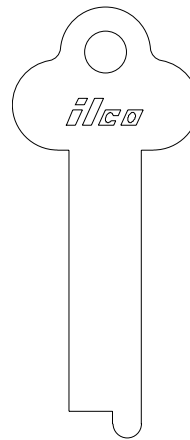
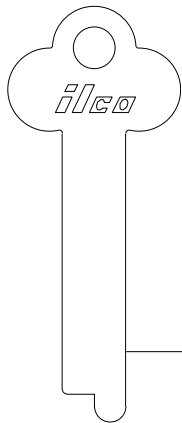

THICK	.050" - 1.3mm	.040" - 1.0mm
WIDTH	.380" - 9.7mm	.380" - 9.7mm
ILCO	1222AL	1222E

.050" - 1.3mm	.050" - 1.3mm
.375" - 9.5mm	.325" - 8.3mm
1222B	1222L

MISCELLANEOUS FLAT STEEL

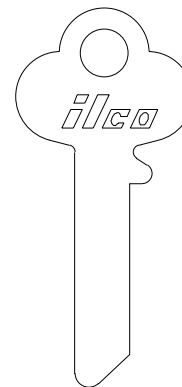
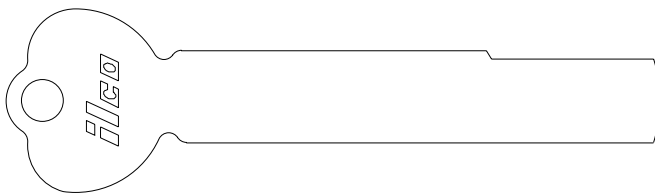

THICK .050" - 1.3mm
 WIDTH .435" - 11.1mm
 ILCO **1226**

.040" - 1.0mm
 .285" - 7.2mm
1239



FLAT STEEL





MISCELLANEOUS FLAT STEEL

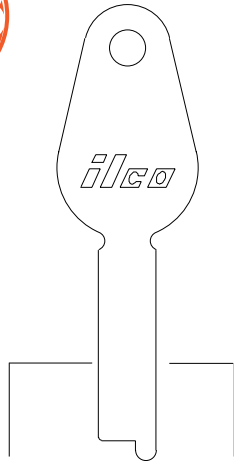

.070" - 1.8mm
.300" - 7.6mm
1242

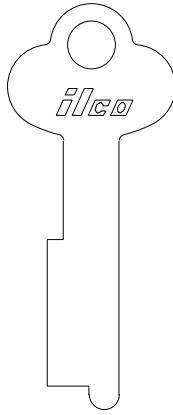

.050" - 1.3mm
.375" - 9.5mm
1243D

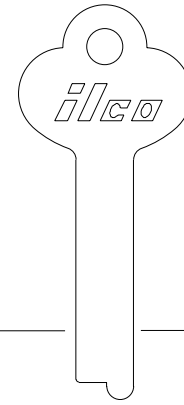

.040" - 1.0mm
.300" - 7.6mm
1270

.060" - 1.5mm
.300" - 7.6mm
1270H

THICK
WIDTH
ILCO

MISCELLANEOUS FLAT STEEL

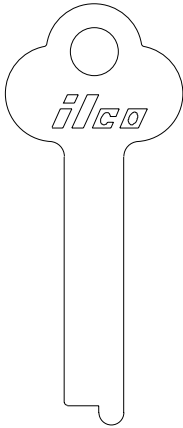

.040" - 1.0mm
.300" - 7.6mm
1270A

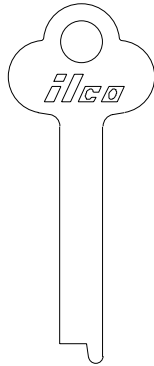

.050" - 1.2mm
.255" - 6.5mm
1270B

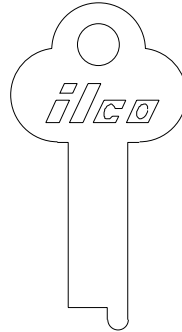

.060" - 1.5mm
.310" - 7.9mm
1270C

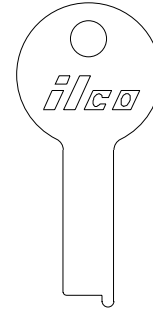

.065" - 1.6mm
.265" - 6.5mm
1271H

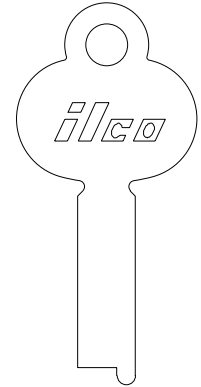

.060" - 1.5mm
.300" - 7.6mm
1303

THICK
WIDTH
ILCO

MISCELLANEOUS FLAT STEEL

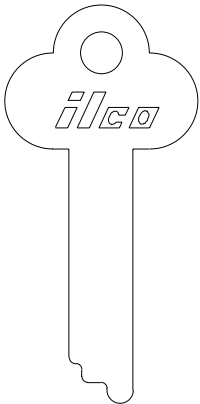

.060" - 1.5mm
.325" - 8.3mm
1306

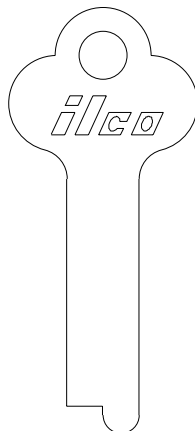

.050" - 1.3mm
.375" - 9.5mm
1306A

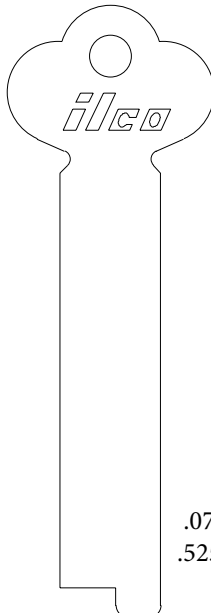

.070" - 1.8mm
.525" - 13.3mm
1309

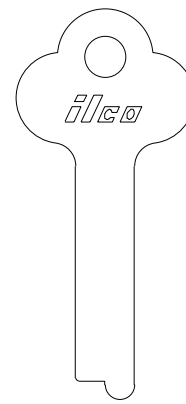

.050" - 1.3mm
.305" - 7.8mm
1321

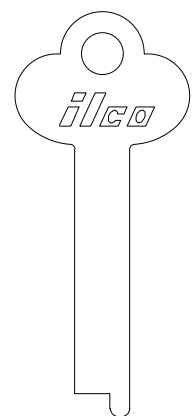

.050" - 1.3mm
.275" - 7.2mm
1366

THICK
WIDTH
ILCO

FLAT STEEL

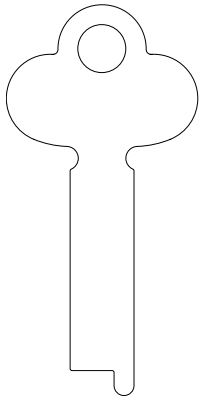

THICK .050" - 1.3mm
WIDTH .335" - 8.5mm
ILCO T37L



FLAT STEEL



THICK
WIDTH
ILCO

THICK
WIDTH
ILCO





AMER.TOURISTER

BELL LOCKER, CABINET LOCK & DUDLEY

CLARK FORK LIFT

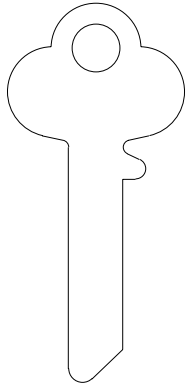

NICKEL SILVER
.040" - 1.0mm
.285" - 7.2mm
1031

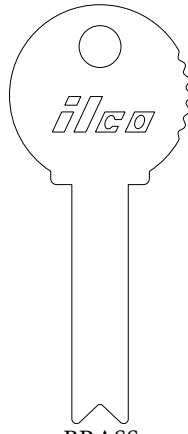

BRASS
.085" - 2.2mm
.295" - 7.5mm
1033F

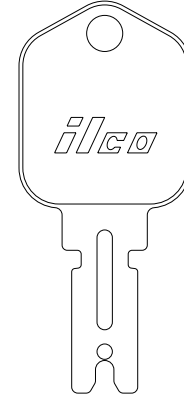

STEEL
.080" - 2.0mm
.344" - 8.7mm
1430

THICK
WIDTH
ILCO

MISCELLANEOUS

CLOCK KEY

DURAND LOCKER

EAGLE

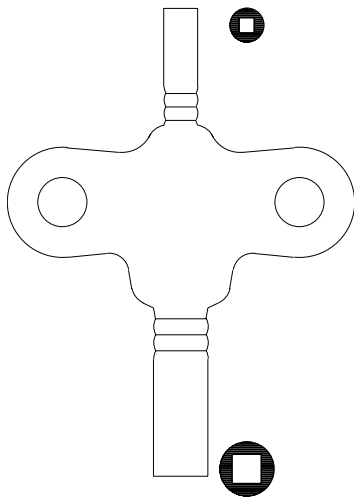

PRECISION CAST
669

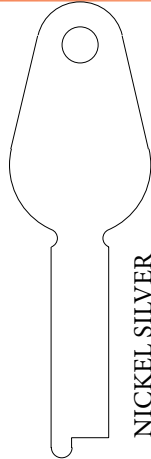

NICKEL SILVER
.060" - 1.5mm
.300" - 7.6mm
1033A

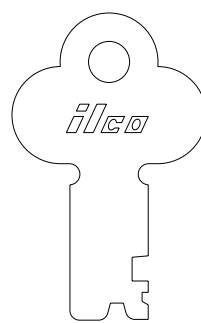

STEEL
.060" - 1.5mm
.041" - 1.04mm
T40

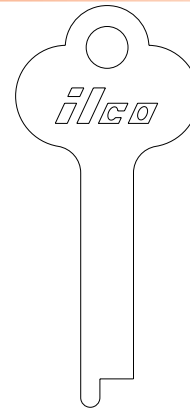

NICKEL SILVER
.050" - 1.3mm
.041" - 1.04mm
1322S

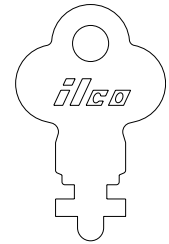

STEEL
.050" - 1.3mm
.365" - 9.3mm
1416

THICK
WIDTH
ILCO

EAGLE

EVERLASTING

GAS & COMBINE

GERSTNER TOOL BOX

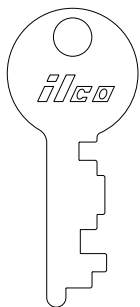

STEEL
.050" - 1.3mm
.312" - 7.92mm
2712

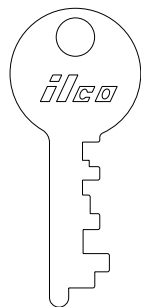

STEEL
.050" - 1.3mm
.312" - 7.92mm
2714

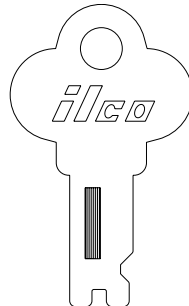

STEEL
T44

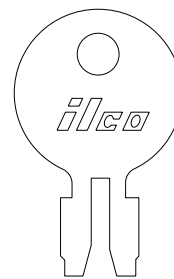

STEEL
666

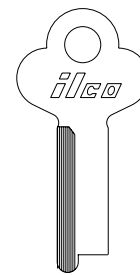

BRASS
1013G

THICK
WIDTH
ILCO

SEC 6B

PG 374



GERSTNER TOOL BOX

LUCAS

LYONS

MEDART

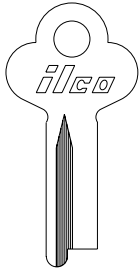

BRASS



1013GR

THICK
WIDTH
ILCO

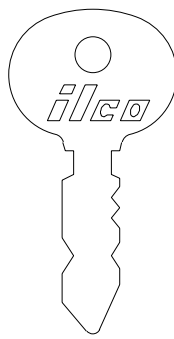

STEEL

.050" - 1.3mm
.300" - 7.6mm

LU1

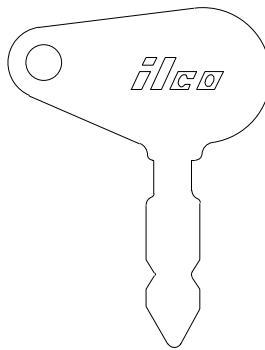

STEEL

.080" - 2.0mm
.279" - 7.09mm

LU2

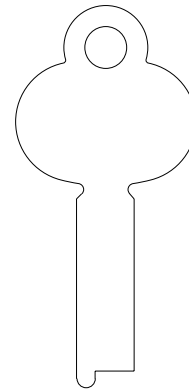

NICKEL SILVER

.060" - 1.5mm
.300" - 7.6mm

1303S

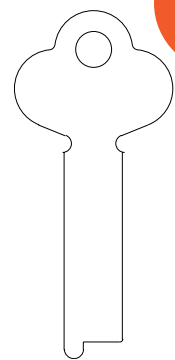

NICKEL SILVER

.060" - 1.5mm
.305" - 7.8mm

1326

MEDART

POLARIS

SAMSONITE

YALE * (Compatible)

MISCELLANEOUS

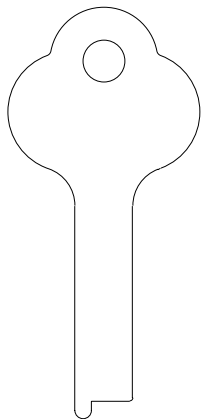

NICKEL SILVER

.060" - 1.5mm
.300" - 7.6mm

1332

THICK
WIDTH
ILCO



STEEL

1148

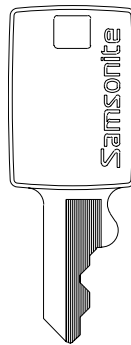

BRASS



70S

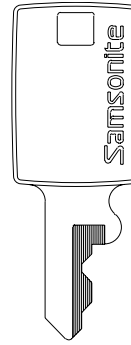

BRASS



170S

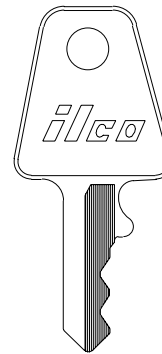

170S6

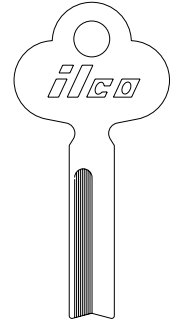

NICKEL SILVER



51

YALE * (Compatible)

MISCELLANEOUS

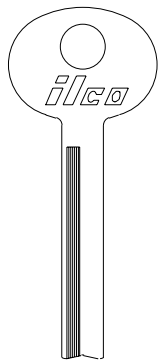

NICKEL SILVER



719S

THICK
WIDTH
ILCO

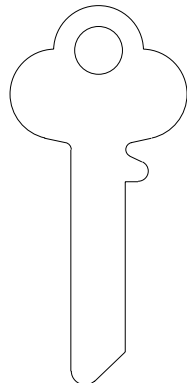

NICKEL SILVER

.040" - 1.0mm
.285" - 7.2mm

1031

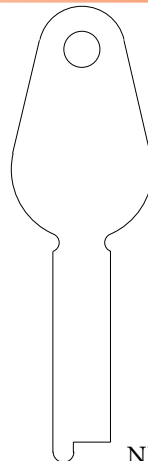

NICKEL SILVER

.060" - 1.5mm
.300" - 7.6mm

1033A



STEEL



T46

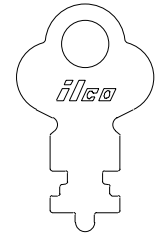

STEEL

T86



*Yale is a trademark of a third party not affiliated or linked with Kaba Ilco or the Dormakaba Group.



MISCELLANEOUS

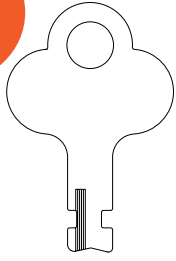

STEEL



T124



STEEL

TS149

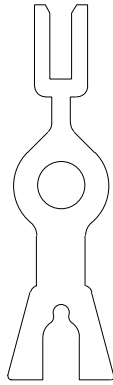

STEEL

TS150

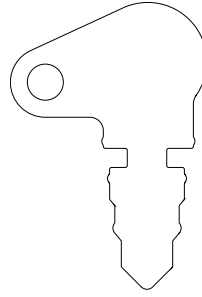

STEEL
.080" - 2.0mm
.412" - 10.46mm
1147

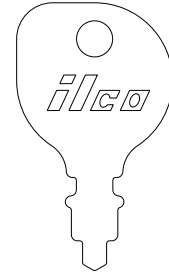

STEEL

1148

THICK
WIDTH
ILCO

MISCELLANEOUS

MISCELLANEOUS

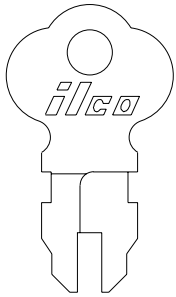

STEEL



3916-22

ILCO

THICK
WIDTH
ILCO

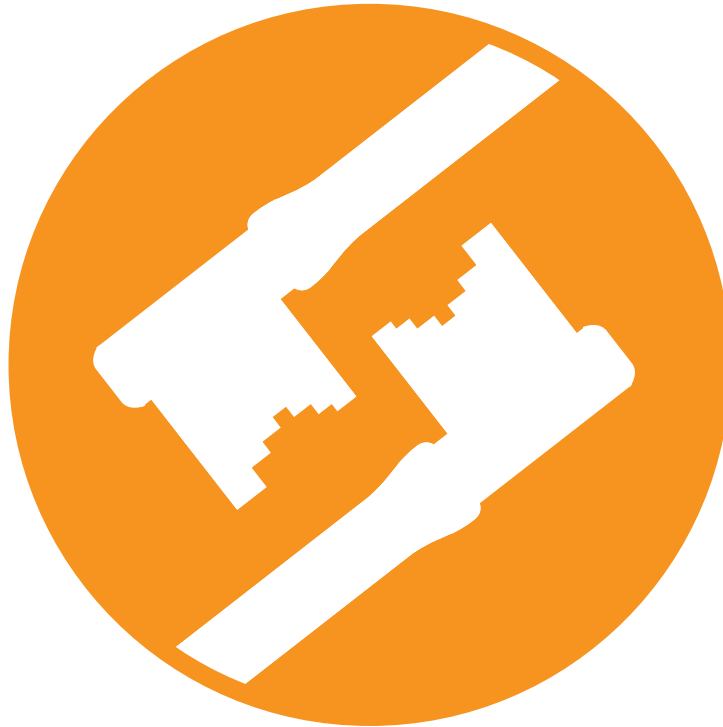

SECTION 7 BIT AND BARREL

Keys are separated by type - bit or barrel and are in number sequence.

DETERMINING SPECIFICATIONS ON BIT KEYS

The following pages show our selection of Bit and Barrel Key Blanks. This page will help you identify the key blank you are looking for.

- The chart below lists various types of material used in Bit and Barrel key blanks.
- Measurements below each key drawing are shown in hundredths of an inch and tenths of a millimeter. Please understand that these styles of key blanks are not made to the same tolerances of cylinder key same tolerances of cylinder key blanks by the nature of the processes utilized. If the dimensions are close they will more than likely work.

Diagrams (left) show how the bit and barrel keys are measured so you can understand what to measure for comparison.

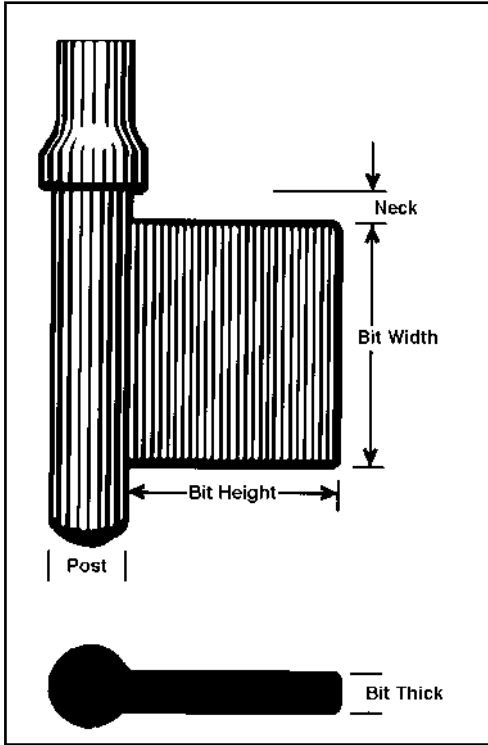

Dimensions of a Bit Key

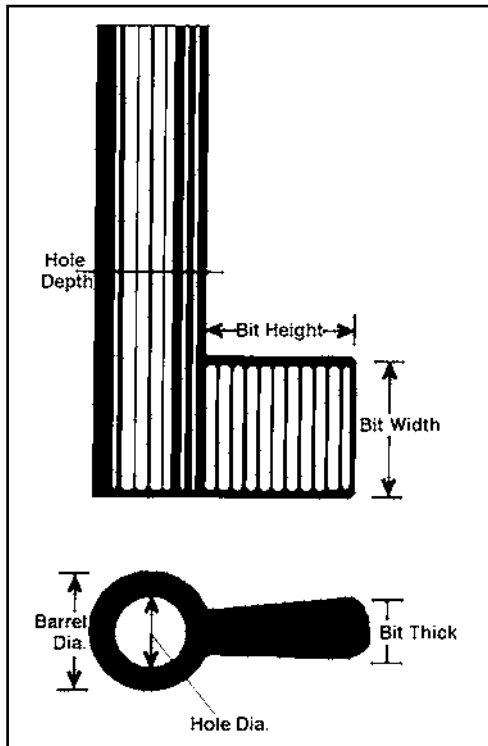

Dimensions of a Barrel Key

Materials Used

MI	- malleable iron
Steel/Plastic	- a nickel plated steel shaft with a plastic tip.
Steel/Zinc	- a nickel plated steel shaft with a die cast zinc tip
Brass	- a brass die cast key blank
Prec. Cast	- a precision zinc die cast key blank

BIT KEYS



BIT AND BARREL

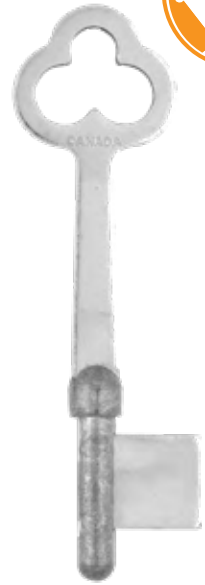

	1B	2B	B2M	5B	B6
ILCO	MI	MI	STEEL/ZINC	MI	STEEL/ZINC
Material	MI	MI	STEEL/ZINC	MI	STEEL/ZINC
Post	.22" (5.6mm)	.16" (4.1mm)	.19" (4.8mm)	.20" (5.1mm)	.20" (5.1mm)
Neck	.11" (2.8mm)	.09" (2.3mm)	.09" (2.3mm)	.09" (2.3mm)	.09" (2.3mm)
Bit Height	.46" (11.7mm)	.39" (9.9mm)	.39" (9.9mm)	.44" (11.2mm)	.47" (11.9mm)
Bit Width	.44" (11.2mm)	.39" (9.9mm)	.39" (9.9mm)	.50" (12.7mm)	.49" (12.4mm)
Bit Thick	.08" (2.0mm)	.08" (2.0mm)	.08" (2.0mm)	.09" (2.3mm)	.08" (2.0mm)

BIT KEYS

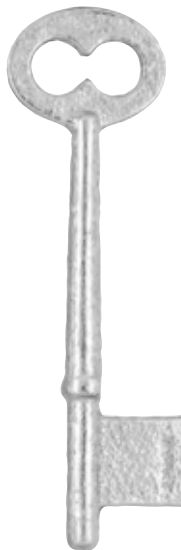
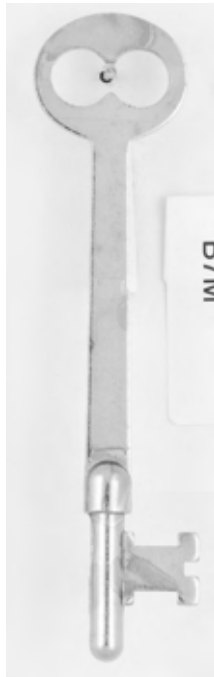

	7B	B7M	8B	9B	12B
ILCO	STEEL/PLASTIC	STEEL/ZINC	MI	MI	MI
Material	STEEL/PLASTIC	STEEL/ZINC	MI	MI	MI
Post	.20" (5.1mm)	.20" (5.1mm)	.19" (4.8mm)	.18" (4.6mm)	.19" (4.8mm)
Neck	.10" (2.5mm)	.10" (2.5mm)	.08" (2.0mm)	.09" (2.3mm)	.07" (1.8mm)
Bit Height	.41" (10.4mm)	.41" (10.4mm)	.50" (12.7mm)	.50" (12.7mm)	.45" (11.4mm)
Bit Width	.39" (9.9mm)	.39" (9.9mm)	.45" (11.4mm)	.49" (12.4mm)	.66" (16.8mm)
Bit Thick	.08" (2.0mm)	.08" (2.0mm)	.08" (2.0mm)	.07" (1.8mm)	.08" (2.0mm)





BIT KEYS



BIT AND BARREL

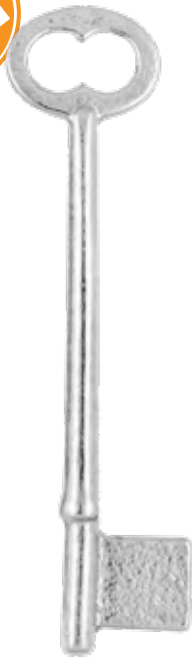

17B



B17



B20



25B



37 MASTER

ILCO

MI		STEEL/ZINC		STEEL/ZINC		MI		MI		Material
.19"	(4.8mm)	.19"	(4.8mm)	.17"	(4.3mm)	.17"	(4.3mm)	.20"	(5.1mm)	Post
.09"	(2.3mm)	.10"	(2.5mm)	.08"	(2.0mm)	-	-	.13"	(3.3mm)	Neck
.50"	(12.7mm)	.50"	(12.7mm)	.40"	(10.2mm)	.69" overall	(17.52mm)	.34"	(11.2mm)	Bit Height
.50"	(12.7mm)	.50"	(12.7mm)	.47"	(11.9mm)	.22"	(5.67mm)	.37"	(11.9mm)	Bit Width
.08"	(2.0mm)	.08"	(2.0mm)	.10"	(2.5mm)	.08"	(2.0mm)	.09"	(2.3mm)	Bit Thick

BIT KEYS



B41A

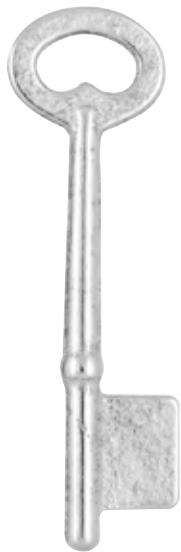

45B



49B



53 MASTER



C53

ILCO

BI-METALIC		MI		MI		MI		PRECISION CAST		Material
.20"	(5.1mm)	.18"	(4.6mm)	.18"	(4.6mm)	.19"	(4.8mm)	.24"	(6.1mm)	Post
.08"	(2.0mm)	.09"	(2.3mm)	.12"	(3.0mm)	.13"	(3.3mm)	-	-	Neck
.50"	(12.7mm)	.43"	(10.9mm)	.37"	(9.4mm)	.43"	(10.9mm)	.48"	(12.2mm)	Bit Height
.59"	(15.0mm)	.62"	(15.7mm)	.35"	(8.9mm)	.46"	(11.7mm)	.38"	(9.7mm)	Bit Width
.09"	(2.3mm)	.06"	(1.5mm)	.06"	(1.5mm)	.09"	(2.3mm)	.17"	(4.30mm)	Bit Thick

BIT KEYS

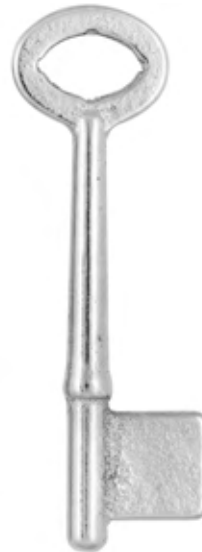
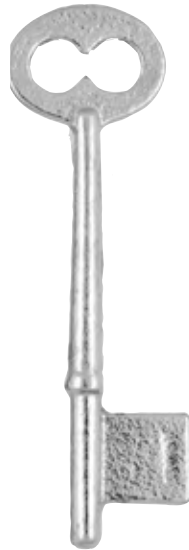

	ILCO 66B	79B	90B	91B	C112
Material	MI	MI	MI	MI	PRECISION CAST
Post	.20" (5.1mm)	.21" (5.3mm)	.18" (4.6mm)	.20" (4.3mm)	.21" (5.3mm)
Neck	.06" (2.5mm)	.12" (3.0mm)	.08" (2.3mm)	.09" (2.3mm)	.08" (2.3mm)
Bit Height	.53" (14.0mm)	.44" (11.2mm)	.53" (11.4mm)	.53" (13.5mm)	.36" (9.1mm)
Bit Width	.50" (12.7mm)	.37" (9.4mm)	.50" (12.7mm)	.57" (14.5mm)	.59" (15.0mm)
Bit Thick	.09" (2.30mm)	.07" (1.8mm)	.09" (2.3mm)	.09" (2.3mm)	.13" (3.3mm)

BIT KEYS



	ILCO 178SB
Material	MI
Post	.26" (6.6mm)
Neck	.09" (2.3mm)
Bit Height	.54" (13.7mm)
Bit Width	.69" (17.5mm)
Bit Thick	.20" (5.0mm)



BIT AND BARREL



BARREL KEYS



BIT AND BARREL



SEC 7

PG 382



21B		22BB		22M		23B		23M		ILCO
MI		MI		MI		MI		MI		Material
.21"	(5.3mm)	.24"	(6.1mm)	.21"	(5.3mm)	.21"	(5.3mm)	.21"	(5.3mm)	Barrel Dia.
.14"	(3.6mm)	.15"	(3.8mm)	.14"	(3.6mm)	.14"	(3.6mm)	.14"	(3.6mm)	Hole Dia.
.68"	(17.3mm)	.80"	(20.3mm)	.50"	(12.7mm)	.50"	(12.7mm)	.47"	(11.9mm)	Hole Depth
.38"	(9.7mm)	.34"	(8.6mm)	.28"	(7.1mm)	.28"	(7.1mm)	.26"	(6.6mm)	Bit Height
.29"	(7.4mm)	.27"	(6.9mm)	.24"	(6.1mm)	.24"	(6.1mm)	.29"	(7.4mm)	Bit Width
.11"	(2.8mm)	.11"	(2.8mm)	.09"	(2.3mm)	.09"	(2.3mm)	.11"	(2.8mm)	Bit Thick

BARREL KEYS



24B		27B		C30M		34B		84B		ILCO
MI		MI		PRECISION CAST		MI		MI		Material
.19"	(4.8mm)	.22"	(5.6mm)	.24"	(6.1mm)	.19"	(4.8mm)	.19"	(4.8mm)	Barrel Dia.
.13"	(3.3mm)	.15"	(3.8mm)	.16"	(4.1mm)	.13"	(3.3mm)	.13"	(3.3mm)	Hole Dia.
.43"	(10.9mm)	.60"	(15.2mm)	.61"	(15.5mm)	.56"	(14.7mm)	.43"	(10.9mm)	Hole Depth
.22"	(5.6mm)	.37"	(9.4mm)	.37"	(9.4mm)	.38"	(9.7mm)	.22"	(5.6mm)	Bit Height
.19"	(4.8mm)	.43"	(10.9mm)	.28"	(7.1mm)	.34"	(8.7mm)	.19"	(4.8mm)	Bit Width
.09"	(2.3mm)	.10"	(2.5mm)	.10"	(2.5mm)	.08"	(2.0mm)	.09"	(2.3mm)	Bit Thick



BARREL KEYS

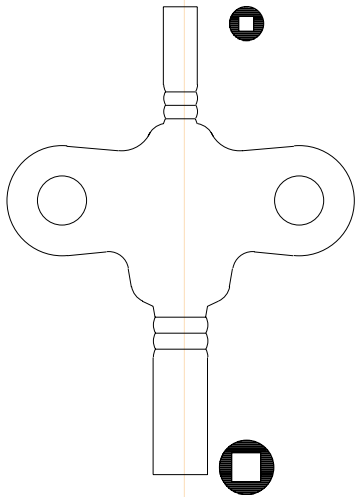

ILCO 669

6750

3F-1033

3F-1232

Material	PRECISION CAST	STEEL	BRASS	BRASS
Barrel Dia.	CLOCK KEY	HANDCUFF KEY	.24" (6.0mm)	.24" (6.0mm)
Hole Dia.			.16" (4.0mm)	.16" (4.0mm)
Hole Depth			.87" (22.0mm)	.87" (22.0mm)
Bit Height			.36" (9.1mm)	.36" (9.1mm)
Bit Width			.35" (9.0mm)	.34" (8.6mm)
Bit Thick			.11" (2.8mm)	.13" (3.2mm)

BARREL KEYS



ILCO 3F-1630

3F-1738

3F-2635

3F-2830

3F-2933

Material	BRASS	BRASS	BRASS	BRASS	BRASS
Barrel Dia.	.23" (6.0mm)	.23" (6.0mm)	.23" (6.0mm)	.23" (6.0mm)	.23" (6.0mm)
Hole Dia.	.16" (4.0mm)	.16" (4.0mm)	.16" (4.0mm)	.16" (4.0mm)	.16" (4.0mm)
Hole Depth	.86" (22.0mm)	.86" (22.0mm)	.86" (22.0mm)	.86" (22.0mm)	.86" (22.0mm)
Bit Height	.36" (9.1mm)	.36" (9.1mm)	.36" (9.1mm)	.36" (9.1mm)	.36" (9.1mm)
Bit Width	.36" (9.1mm)	.34" (8.8mm)	.35" (9.0mm)	.36" (9.1mm)	.35" (9.0mm)
Bit Thick	.12" (3.0mm)	.12" (3.0mm)	.13" (3.2mm)	.13" (3.2mm)	.11" (2.9mm)





BARREL KEYS



BIT AND BARREL



SEC 7

PG 384



3F-4333		3F-4535		3F-4735		3F-4935		3F-6932		ILCO
BRASS		BRASS		BRASS		BRASS		BRASS		Material
.23"	(6.0mm)	.23"	(6.0mm)	.23"	(6.0mm)	.23"	(6.0mm)	.23"	(6.0mm)	Barrel Dia.
.16"	(4.0mm)	.16"	(4.0mm)	.16"	(4.0mm)	.16"	(4.0mm)	.16"	(4.0mm)	Hole Dia.
.86"	(22.0mm)	.86"	(22.0mm)	.86"	(22.0mm)	.86"	(22.0mm)	.86"	(22.0mm)	Hole Depth
.36"	(9.1mm)	.36"	(9.1mm)	.36"	(9.1mm)	.36"	(9.1mm)	.36"	(9.1mm)	Bit Height
.34"	(8.8mm)	.35"	(9.0mm)	.34"	(8.7mm)	.35"	(9.0mm)	.34"	(8.6mm)	Bit Width
.12"	(3.0mm)	.10"	(2.5mm)	.12"	(3.0mm)	.12"	(3.1mm)	.14"	(3.5mm)	Bit Thick

BARREL KEYS



3M-5935		3S-1832		3S-2332		3S-5332		ILCO
BRASS		BRASS		BRASS		BRASS		Material
.22"	(5.7mm)	.23"	(6.0mm)	.23"	(6.0mm)	.23"	(6.0mm)	Barrel Dia.
.14"	(3.5mm)	.16"	(4.0mm)	.16"	(4.0mm)	.16"	(4.0mm)	Hole Dia.
.86"	(22.0mm)	.86"	(22.0mm)	.86"	(22.0mm)	.86"	(22.0mm)	Hole Depth
.25"	(6.4mm)	.35"	(9.0mm)	.36"	(9.1mm)	.36"	(9.1mm)	Bit Height
.30"	(7.6mm)	.35"	(9.0mm)	.35"	(9.0mm)	.35"	(9.0mm)	Bit Width
.10"	(2.5mm)	.14"	(3.5mm)	.12"	(3.0mm)	.12"	(3.0mm)	Bit Thick





SECTION 8A SPECIALTY KEYS

This section contains Large Bow, Neuter Bow, Personalized Keys and Painted Keys.



SECTION 8B MERCHANTISING AIDS

This section describes available ways to merchandise Ilco® key blanks.

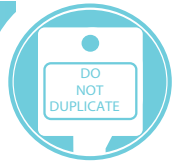

Decorated (Painted) Keys

Your consumer's eyes are sure to be drawn to this line of keys. Whether they are choosing a fun way to express their individual style or a functional way to differentiate one key from another, this popular category offers an ever changing variety of designs, patterns, and officially licensed key blanks. **See our web site for the latest designs.**

Our patented decorating process allows for intricate, detailed designs as well as a specific and precise color match. This specialized process also provides Ilco brand decorated keys with a durable, scratch and chip resistant finish.

Personalized Keys

These keys are made to help you to promote your business and assure repeat business. Ilco offers you a wide variety of keyways and bow (head) styles for your personalized information. Two types of personalization are available: state-of-the-art laser engraving or a high quality embossed customer logo and/or other information. You can also choose from original manufacturers bow shapes, the neuter/security bow, or from several custom shapes.

Neuter Bow Keys

Security Head keys have a common or "neuter" bow and may be incised with "DO NOT DUPLICATE". The common bow does not have an identifying number which helps to deter unauthorized duplication. The back of the key is blank and may be imprinted with your specific information, room numbers, etc. The most popular residential and commercial keyways are available in this line of keys.

Large Bow Keys

Large bow keys (also known as hotel keys) offer your customers another option to meet their requirements. This line is made from nickel silver stock to provide greater torque strength providing more resistance to twisting and breakage. Keys feature a "blank" area for stamping. This line may also be coined to your specification by adding logos and special designs.

Color Plastic Head Keys

Color plastic head keys offer your customers another solution for visual identification.

Ilco offers two styles for you to choose from: Cool Colors are a line of "soft-gel", transparent color plastic head keys. Solid Color Plastic Head include an opaque color plastic that is framed in metal.

SPECIALTY KEYS



Key Center

The modular Key Cutting Center allows you to maximize profits per square foot. From a small footprint, you have the flexibility to build from a smaller, single tier tower to the large double tower with the most popular of both residential and commercial key blanks.

Add Key Tower accessories that fit your requirements. Accessories include a 4-wheel cart with built in shelving, to garage side racks for "niche" keys, to a garage with shelf for additional equipment of storage.

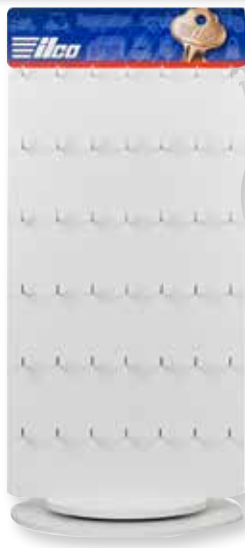



Displays

For merchandising, choose from rotating racks, carded racks or flat panel display. Our selection of displays range from small "free-standing" to large "wall-mounted". These are perfect for consolidating consumer favorites such as painted keys.

A specialized grouping of painted keys can be featured on a small acrylic display. This display with insert is included with many of our assortments or you can order the plain display and develop you own insert for localized, personal promotions.

Displays are updated to meet changing requirements. **Check with your distributor for current offerings.**

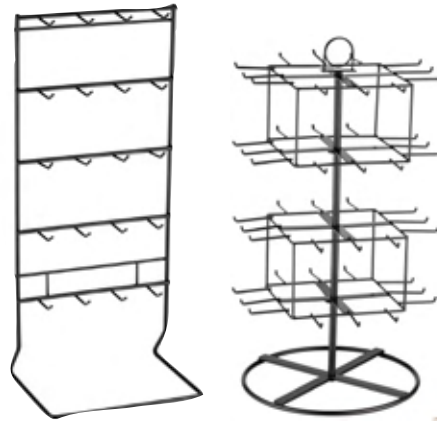

Point of Sale (POS) Support

Iico offers an ever changing assortment of POS support materials. This includes signs, banners, decals, and more to help maintain and support product sales.

POS support items are updated to meet changing requirements. **Check with your distributor for current offerings.**





SECTION 9 KEY MACHINES

This section presents the current line-up of Ilco® and Silca® brand standard and specialty key machines.



Flash 008

Manual Operation

Lightweight, compact and portable, the Flash 008 is an ideal choice for on-site, mobile jobs or counter tops where space may be limited. This manually operated duplicator is designed to cut cylinder, cruciform, large bow and long blade keys.

Weight: 14 lbs. (6.4 kg)
Dim.: 12.2"W x 9.5"D x 8.7H
(31cm x 24cm x 20cm)



Flash Mobile

Manual Operation

Battery-operated version of the popular Flash 008 machine that makes it a truly "mobile" machine. The 2900mAh battery allows the machine to operate at 2200 RPM and will cut 300+ brass keys in a single charge.

Weight: 15.4 lbs. (7 kg)
Dim.: 16"W x 11"D x 15"H
(27.9cm x 40.6cm x 38.1cm)



Speed 045

Manual Operation

Speed 045 is an ideal basic duplicator that is designed with features that any user will readily appreciate. The open style, safety details and operational features make this model a choice model for store or shop. The included mounting bracket makes it an excellent choice for mobile use.

Weight: 31 lbs. (14 kg)
Dim.: 15.75"W x 18.1" D x 9.8"H
(40cm x 46cm x 25cm)



Twister II

Manual Operation

Twister II provides convenience, accuracy and precision at a modest price point and allows for expansion of capabilities with the optional accessories. Lightweight, compact design with a small footprint makes this duplicator a perfect choice for mobile applications. The lockable carriage prevents movement during transport.

Weight: 53 lbs. (24 kg)
Dim.: 14.6"W x 9.8" D x 14.6"H
(37cm x 25cm x 37cm)





Matrix II
Manual Operation

Matrix II is a premium duplicator that includes LED lighting and electromechanical calibration. Rugged construction combined with many user preferred features make this model a professionals choice for high security key duplications

Weight: 54.23 lbs. (24.6 kg)
Dim.: 12.2"W x 15.75" D x 18.5"H
(31cm x 40cm [including side lever] x 47cm)



Speed 046
Manual Operation – Flat Keys

The Speed 046 provides an economical and accurate manual cutting solution for duplication of flat type keys such as Safe, Safe Deposit and Mailbox keys. With the mounting bracket included; this is also an excellent choice for mobile use.

Weight: 31 lbs. (14 kg)
Dim.: 15.75"W x 18.1" D x 9.8"H
(40cm x 46cm x 25cm)

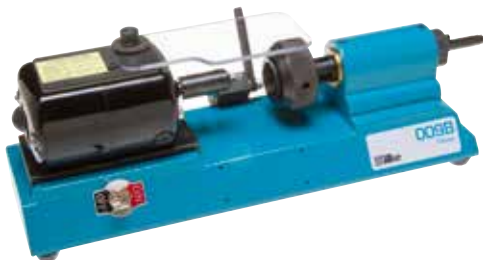

009B
Manual Operation – Tubular Keys

The 009B is an economical solution for duplicating standard tubular keys and with the popularity of tubular applications, makes the perfect addition to any key cutting services. Simple to operate and the unique key positioning device to assure quick, accurate gauging of the tubular key blank.

Weight: 8 lbs. (3.62 kg)
Dim.: 14"W x 4.25" D x 4.25"H
(35.6cm x 10.8cm x 10.8cm)



Duo Plus
Manual Operation – Edge, Bit, Flat, Abus® and Abloy® Keys

Duo Plus is an innovative, dual carriage machine that cuts cylinder, vehicle and cruciform keys (left-hand carriage) as well as bit, double bit, flat style (safe, safety deposit, mailbox) and special keys such as Abus® and Abloy® type keys (right-hand carriage).

Weight: 50.7 lbs. (23 kg)
Dim.: 20.1"W x 17.7" D x 11"H
(51cm x 45cm x 28cm):



Speed 044

Lever Operation (Semi-Automatic)

The spring-loaded carriage on Speed 044 is engaged by the press of a button. The lever is then moved manually to control the carriage movement during the cutting cycle.

Weight: 31 lbs. (14 kg)
Dim.: 22.8"W x 18.1" D x 9.8"H
(58cm x 46cm x 25cm)



Crown

Lever Assisted Specialty (High Security)

The self centering synchronized key vise clamps are designed for precision duplication of tubular keys. In addition to the key styles that can be duplicated by the standard key vise clamps, additional clamps are available for cutting highly specialized tubular key types. (T10 Jaw is supplied with machine.)

Weight: 37.4 lbs. (17 kg)
Dim.: 9"W x 17.75" D x 7"H
(23cm x 45cm x 18cm)



Speed 040

Automatic / Manual Operation

The Speed 040 is primarily an automatic model with the flexibility to be operated manually.

Weight: 44 lbs. (20kg)
Dim.: 19"W x 18.1" D x 9.8"H
(49cm x 46cm x 25cm)



KD50C

Semi-Automatic Duplicator (Cylinder/Automotive)

Remarkable speed and accuracy in a superbly crafted machine. Cuts single sided keys in as little as five seconds! The vise jaws are engineered to grip even the most troublesome double-sided auto keys. Loaded with features every user will appreciate. Superior design provides outstanding cutting accuracy and dependable, long term performance.

Weight: 55 lbs. (25 kg)
Dim.: 16"W x 18"D x 10"H
(41cm x 46cm x 25cm)





**Bravo III (with EZ-Jaw™ vises)
Semi-Automatic Duplicator (Cylinder/Automotive)**

A sturdy machine designed to deliver years of service. The Bravo III features quickly to rotatable, EZ-Grip 4-position vise jaws, twin carriage shafts, a safety release carriage, and a micrometer adjustable tracing guide. Precision machine d part and ergonomic design provide for unsurpassed accuracy and ease of use.

Weight: 42 lbs. (21kg)
Dim.: 15"W x 18"D, x 9.5"H
(42cm x 53cm x 30cm)



**Delta FO - Manual
Specialty (High Security) Code Machine**

Simple to operate, the Delta FO is designed to cut by code the unique cuts required for Ford Tibbe® and Jaguar Tibbe® style keys. Ergonomic design, direct drive motor and high strength polymer bas makes the Delta FO the ideal solution for cutting these high security keys.

Weight: 30 lbs. (17kg)
Dim.: 8.5"W x 14.75"D, x 10"H
(21cm x 3cm x 25cm)



**UC199
Electronic**

The UC199 is a high precision electronic key cutting machine for single and double sided edge cut keys and cruciform keys. The UC199 combines precision and ease of use as well as high quality results due to its innovative functions and laser technology. In stand-alone mode, UC199 performs quality key duplication from an original key including ability to adjust cuts for worn keys. Originate keys by code via PC with software program

Weight: 94.8 lbs. (43kg), 110.2 lbs (50kg with optional feeder)
Dim.: 15.6"W [With optional box 18"] x 21.4"D, x 15.2"H
(39.6cm x 54.3cm [With optional box 45.8cm"] x 38.6cm)



Futura Edge

Built on the successful Futura platform, the Futura Edge is designed for edge cut keys. The Futura Edge will easily duplicate by copying from the original key, by indirect code or by direct code. Like the Futura Pro, this model is powerful enough for the professional and ideal for inexperienced users thanks to the software-guided procedures.

Weight: 35.3lbs. (19 kg)
Dim.: 12.52"W x 16.26"D, x 20.47"H [13.13" without tablet]
(31.8cm x 41.3cm x 52.2cm [34cm without tablet])



Futura Edge Plus

Built on the successful Futura Edge platform, the Futura Edge Plus is designed so that edge-cut keys can be easily duplicated by copying from the original key, by indirect code or by direct code. The main feature of the Futura Edge Plus is a tilting cutter unit that also allows the cutting and decoding of Medeco® biaxial keys and operates in 3 positions. The Futura Edge Plus is powerful enough for the professional and ideal for inexperienced users thanks to the software-guided procedures. Designed and engineered to the highest quality standards; you can be assured of precise origination and duplication of edge-cut keys and Medeco® biaxial keys.

Weight: 39.47lbs. (17.9 kg)

Dim.: 12.52"W x 16.26"D, x 20.47"H [13.38" without tablet]
(31.8cm x 41.3cm x 52.2cm [34cm without tablet])

Futura Auto

The electronic key cutting machine with one cutting station and two interchangeable clamps for duplicating and originating all types of automotive keys, including heavy trucks and motorcycles. Additional keys used for gas cap locks, glove boxes and roof racks are also included in the database.

Weight: 44lbs. (20 kg)

Dim.: 12.52"W x 16.26"D, x 20.47"H [13.38" without tablet]
(31.8cm x 41.3cm x 52.2cm [34cm without tablet])

Futura Pro One Electronic

Designed specifically for cutting laser and dimple style keys. Quick change optional accessories provide the additional capability to cut tubular and Tibbe® style keys. Controlled with a removable 10" (254 mm) touch screen tablet which guides users step-by-step through key cutting operations.

Weight: 42 lbs. (19 kg)

Dim.: 12.52"W x 16.26"D, x 20.47"H [13.38" without tablet]
(31.8cm x 41.3cm x 52.2cm [34cm without tablet])

Triax Pro Electronic (Special Order – 230V Only)

Triax Pro is designed for the professional for decoding, cutting by code or from original, laser and dimple keys. Triax Pro also has the ability to engrave keys and key tags. Operates stand-alone or PC mode.

Weight: 113.54 lbs. (51.5 kg)

Dim.: 17.72"W x 20.08"D, x 13.38" without tablet
(45cm x 51cm x 34cm without tablet)





Idea

Electronic (Special Order – 230V Only)

Electronic key cutting machine for code cutting and duplication of bit and double bit keys, pump keys and “English” keys (with shoulder). Idea has a wide range of automatic operations that ensures precision within hundreds of a millimeter and provides a fast cutting cycle.

Weight: 102.3 lbs. (46.4kg)
Dim.: 15.75”W x 20.47”D, x 17.72”H
(40cm x 52cm x 45cm)



Futura Pro

Electronic

A unique electronic key cutting machine combining two cutting stations in one user-friendly device that can cut a variety of key styles in one innovative machine. A powerful machine for professional key cutters yet also ideal for inexperienced key cutters thanks to the software guided procedures throughout the cutting process.

Weight: 42 lbs. (19kg)
Dim.: 12.52”W x 16.26”D, x 20.47”H [13.38” without tablet]
(31.8cm x 41.3cm x 52.2cm [(34.0mm) without tablet])



Unocode F900

Designed for specialist locksmiths, Silca’s latest electronic key cutting machine automates and simplifies the complete key duplication process to improve the speed and quality of service to your customer. Faster key duplication means significantly improved returns on each key sold for you. The exclusive Unocode F900 is the truly all-in-one solution for duplicating flat keys, automating the key feeding, engraving, cutting and sorting leaving you free to manage your next customer.

Weight: 193.3 lbs. (87.7kg)
Dim.: 36.26”W x 29.13”D, x 26.77”H
(92.1cm x 74.2cm x 68cm)



Engrave-It™

Engrave keys, pet tags, luggage tags, ID tags and brass plates with this durable, compact engraving unit. Featuring simple menu driven operation, the Engrave-It is the perfect complement to key duplication services. A broad range of engraveable tag items is available. Visit our website www.kaba-ilco.com to view the versatile Engrave-It in operation.

Weight: 48 lbs (21.7kg)
Dim.: 13.5”W x 13.25”D x 14.5” H
(34.3cm x 33.65cm x 36.8cm)



Engrave-It™ XP Electronic Engraving

The Engrave-It™ XP is designed as a mid-level engraving machine suitable for store, shop or an institutional environment. This unit engraves keys, sides of IC Cores, brass and laminated ID plates / tags, pet tags, luggage tags and more. Optional trays are available for a wide variety of keys and IC cores with engraving templates built in. Using powerful engraving software with your PC, the operator can quickly select from a menu of common templates or create their own custom settings to engrave other items.

Weight: 38 lbs. (17.2kg)
Table: 6" W x 8" D (152.4 mm x 203 mm)
Dim.: 17.5"W x 17.5"D, x 9.5"H
(44.4cm x 44.4cm x 24.1cm)



Engrave-It Pro

A commercial duty engraving product for engraving multiples of the same item. Accessory key blank holders accommodate up to 24 blanks at a time cylinder and core holder capacity varies dependent on item size. Can also be used for engraving brass metal plates and ID tags. A broad range of accessory holders are available. Includes special software and is intended for use with a customer supplied PC. Visit our website www.kaba-ilco.com to view the Engrave-It in operation!

Weight: 38 lbs. (17.2kg)
Table: 6" W x 8" D (152.4 mm x 203 mm)
Dim.: 17.5"W x 17.5"D, x 9.5"H
(44.4cm x 44.4cm x 24.1cm)



Marker 2000 Electronic Micro Point Style Imprinter

Designed for use in the professional market, the Marker 2000 will easily imprint keys, medallions, tags. Mark cylinders with the optional C7 Jaw. The unit's built-in computer uses a variety of type styles and sizes to mark up to four lines of text. By connecting to a PC, capability may be enhanced to include graphics and increases text database storage (optional software required).

Weight: 44 lbs. (20kg)
Dim.: 8.66"W x 12.6"D, x 17.72"H
(22cm x 32cm x 45cm)





**RW4 PLUS - Encoder
Detectors/Encoders - Transponder**

A self contained, stand alone cloning device that is capable of cloning all faxed code transponders plus Texas Instruments and Philips encrypted code transponders. Also identifies presence of th transponder and indicates chip type, value, and manufacturer. Code generation and archiving capabilities also come standard. No PC, internet connection, or additional software required.

Weight: .61 lb (.27 kg)
Dim.: 9.5"W x 6.5"D x 6.5"H
(24.1cm x 16.5cm x 16.5cm)



**Ilco-EZ@-Clone PLUS - Encoder
Detectors/Encoders**

A self-contained, stand alone cloning device that is capable of cloning all fixed code transponders plus Texas Instruments and Philips encrypted code transponders. Also identifies presence of a transponder and indicates chip type, value and manufacturer. Simple two button (Read/Write) operation.

Weight: .61 lb.(.27 kg)
Dim.: 9.5"W x 6.5"D x 6.5"H
(24.1cm x 16.5cm x 16.5cm)



**Smart Pro-Interface Device
Detectors/Encoders-Transponder**

Smart Pro is a state-of-the-art vehicle key programmer that provides fast, easy and intuitive programming via the graphical user interface. Software is driven by MYKEYS Pro, the online key programming database with information for over 5000 vehicles; covering most makes and models worldwide. Smart Pro is used for adding and deleting vehicle transponder keys, proximity fobs, and remote keyless entry fobs.

Expertly engineered with high-quality components ensures you of high-security standards and outstanding performance. The customized operating system has been designed and developed by Advanced Diagnostics; the foremost authority in vehicle key programming.

Weight: 6.4 lbs. (2.9kg)
Dim: 12.7"W x 2.6"D x 8"H
(322mm x 68mm x 203mm)



**M-Box-Encoder
Detectors/Encoders**

The latest cloning solution for Megamos Crypto ID48 transponders and Texas Instruments 80 bit transponders as well as allowing Ilco/Silca cloning tools to interface with MYKEYS Safe.

The M-Box with M-Snoop is add-on hardware that adds the capability of cloning Megamos® ID48 equipped transponder keys for Volkswagen, Audi, Volvo, and more. Most recently the M-Box adds the capability to clone transponder keys equipped with the Texas Instruments® 80 bit transponder for Ford, Hyundai, and Kia.

The M-Box is compatible with existing Ilco/Silca cloning devices while the unique U-Snoop allows for capture of original key data without the need to cut a new key. The M-Box can connect to Wi-Fi or use a wired internet connection. The M-Box brings total cloning capability to approximately 95% of transponder key equipped vehicles in North America today.

Weight: 1 lb. (.45kg)
Dim: 9.625"W x 6.25"D x 1.5"H
(24.45cm x 15.88cm x 3.81cm)



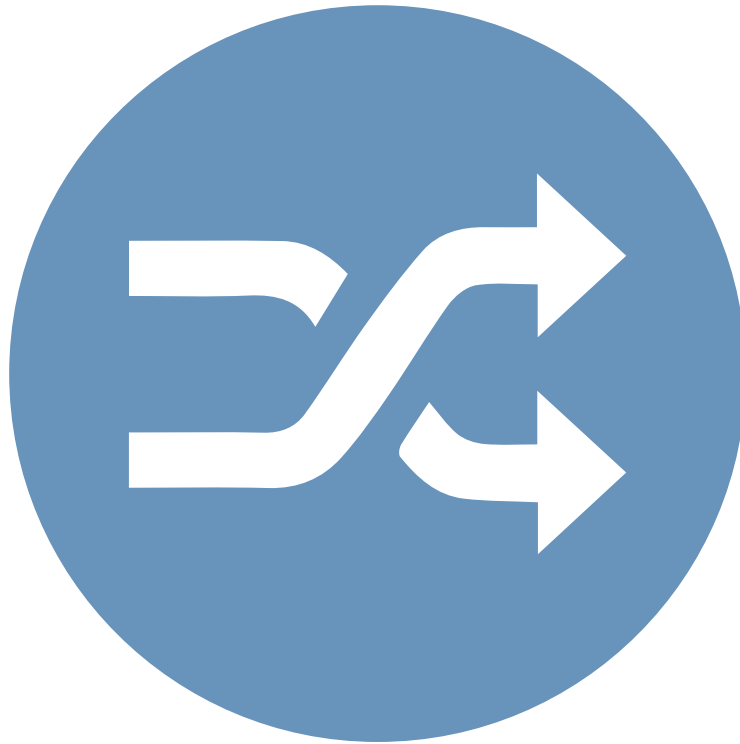

SECTION 10 CROSS REFERENCE

This section lists major lock and replacement key manufacturers in alphabetical order and their key numbers in the appropriate sequence. The ILCO key equivalent is listed beside the original or competitors' key number. This listing is set up as a functional cross reference. Certain replacement key manufacturers have been omitted due to laws in their respective countries concerning the publishing of a cross reference.

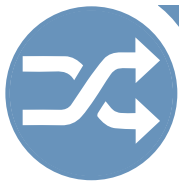

ALBA

ALBA	ILCO
A1	H1098LA
A12/A15	X1199AR
A21/A22	H1098NR
A23	H1098DB
A24/A28D	H1098M
A24N/A24R	1098M
A24RN/A23R	1098DB
A29X	D1759L
A38	F91C
A4	H199A
A43	1767CH
A43N	1704K
A44/A68	P1770U
A44N	S1767CH
A45	63JA
A46C	NE11
A46R	NE39
A47C	VR61S
A48	MR63E
A48A	HF1
A48B	A62VN
A5	1199DR
A50	R62PF
A50C	62PF
A50D	R62PD
A50M	YM6
A50N	R62PG
A51	V61A
A58A	63TV
A59	63TW
A6/A7	H1098A
A60	BR6
A61A	DT15
A61C	DT16
A61N	X6
A61NC	X7
A61NP	DAT6P
A63	YM8
A63A	UR62VP
A64	P1098A
A64A	1970AM
A64P	B48-P
A65	S1098B
A65P/FC36	B49-P
A66	P1098C
A66NP	B64-P
A66P/X25	B50-P
A67	S1098D
A67P	B51-P
A68P	Y153-P
A69	S1770U
A70	P1098E
A70P	B44-P
A71	S1970AM

ALBA	ILCO	ALBA	ILCO	ALBA	ILCO	ALBA	ILCO
A72	P1098J	E27	1041GR	EX8A	MB15	FC4	N1286
A73	S1098H	E28	1041GA	EX8B	MB18	FC5	1286B
A73P	B45-P	E2L	1001EA	EX9	FT38	H51	1167FD
A74	T61D	E3	1009	EX92	X193	HD99	X204
A74L	X137	E38	SX1000F	EX9A	FT37	IN20/R26A	X1054K
A74LC	X121	E38A	XO1000FR	EYA1C	H999R	M1	1092
A75	U1770CH	E3L	1009A	EYA3/Y3/Y5	H997E	M12	170S
A76	RT19	E40	1016N	EYA3C/Y4	H997ER	M15/M1L	1092N
A77	LM1	E41/Y41	X117	F1	1125D	M15A	1092H
A78	S1098K	E42A	1549	F16	62DG	M16/M6L	1092J
A79C	X123	E42AN	9MX	F16C	62DC	M18	1092D
A79CAP	DA31-P	E42DN	1548	F16N	62DP	M19	PZ1
A79CP	DA25-P	E45/E45A	1041W	F17	HF35	M1C	1092R
A8/A10	X1199B	E4A	1010U	F17C	HF17	M2/M2C	1092VR
A80	X124	E5	1022	F19	61VW	M6	VR91
A81	P1789	E7	1011	F1M	M1127A	M6C	VR91R
A81A	P1793	E79	1014	F2	1125F	M9	L67A
A81AP	Y155-P	E80	1014F	F22	LR62VJ	MZ20	X199
A81D	P1794	E84	1007LF	F22N	62PE	P109	1233M
A81DP	Y157-P	E84A	1007LB	F23N	L62VJ	P110	633MH
A81P	Y154-P	E84D	1007LG	F24	61G	P2	1210A
A82	P1099	E88	A1114A	F24A	R61G	P45	1569
A82A	P1101	E97AN	R1001EN	F24D	R61D	P5	1215B
A82P	B68-P	EAZ3/R8L	999A	F24DC	61D	R12L	998
A83P	DA30-P	ETE1C	TE1	F28	VW63A	R11/Y5E/Y6	H999
A84P/F41LPMB18-P		ETE8C/R59	TE4	F29	VW63	R20A	1553
A86	X168	EV35/R1	999	F2A/H50	S1167FD	R20C/E10L	1041G
A88	X180	EV35C/P36/R2	999R	F2E	1193FD	R20N	1585
A89	P1106	EX10	P1098V	F2EP	H67-P	R24	LP21W
A89P	B86-P	EX11/F36C/F36CP		F2H	1196FD	R25	S54F-PC
A89S	P1107		VW71A	F2L/H54	1184FD	R26	1054K
A89SP	B89-P	EX11A	V27	F2LL	1190LN	R30	1016
C3	687Y	EX12A	X51	F2LL-P	1185T-P	R38	1033D
CG16	1041T	EX12C	X138	F2X	1127DU	R4	1079B
CO26/T25	1000V	EX13	X46	F30	R62DH	R42	R61T
CO6E/E120	X999	EX14	X27	F30C	62DK	R42A/R62	61T
CY10	1N	EX14A	X26	F33	B62DR	R46	D1098B
CY4	1	EX17	BR16	F35/F35P	VW71	R47	A1054KD
E1	1001EN	EX20	X71	F37	X1	R47L	D1054KA
E10/E24	1041GB	EX21/MZ13	X131	F39	VC29	R47N	D1054K
E105	1096C	EX21C	MZ13R	F40	BU4	R5	1079
E106	R1001EM	EX21L	X188	F41/F50	X9	R52	PHA1
E107/E11L/E2LL		EX21P	MZ13-P	F41P/F50P	73VB-P	R52L	PHA2
1001EL		EX22	X174	F42/F47	X92	R53	1054WB
E108N	1175N	EX23A/MZ19	X201	F43	NE14	R53L	A1054WB
E109	1176	EX24A	X217	F44	NE15	R53N	1054WC
E110	D1098X	EX26	X160	F45	X61	R55	R63
E119/HL1	1003M	EX27	X187	F46	X53	R57	R64
E119C/HL2	R1003M	EX28	X216	F48	X85	R60	CB10
E12L	1000F	EX29	X196	F51	X139	R61	1045
E12LD	1000FR	EX30	X198	F52	NE34	R61L	A1045
E14	1013	EX31	X154	F53	X116	R63	1179
E16L	L1014D	EX33	X214	F53P	RN24-P	R63L	1179A
E19	C1041DN	EX34/HD92	X183	F54	X221	R65	R1064E
E1L	1001EG	EX36	X224	F8	1132	R66	1069LB
E21L	1001A	EX39	X144	FC15	1286BR	R67	1011D1
E22	1000	EX40	X140	FC25	SLA13	R67L	A1011D1
E22LL	1000A	EX7	X54	FC26	SLA11	R69	PR91C
E23	1041FG	EX8	MB16	FC3	R1286E	R6L	1054DL





ALBA	ILCO	AMERICAN	BEST	ILCO	B & S	ILCO		
RGA	998GA	AMERICAN	ILCO	1APWH1	1A1WH1	321622	S1098WD	
RGD	998GD	BKB	1041C	1APWY1	1A1WY1	321645	1190LN	
RGE	998GE	BKB-A	1041CK	BRIGGS & STRATTON		321645	1184FD	
RGH	998GH	BKB-C	1041CE	B & S		321648	1185FD	
RGK	998GK	HTKB-7	1137B	ILCO		321750	P1098WC	B & S
S1	1307A	LPKB-4	1041B	320083	1759P	321951	S1098WH	597791
S10	1145E	PT747-1	A1041U	320083	D1759L	322000	P1789	597796
S14	A1145CE	PTKB-1	1046	320083	1764S	322050	P1098WE	597798
S15	A1145L	PTKB-1	1045L	320315	X1199G	322177	B85G	597800
S16	1145CE	PTKB-2	A1045L	320315	XO1199G	322465	B92GV	598007
S17	A1145EF	ARROW		320315	1701G	322727	1098M	598009
S1A	R1307A	ARROW	ILCO	320315	1766S	323789	Y158VCHY	598152
S1B/S20	L1307A	K2	1179	320321	S1170LN	593196	B48-P	598152
S5	1145A	K2	1179SC	320321	S1127FD	593196	B48-PC	598333
S6/SC1	1145	K3	N1179	320321	S1127ME	593196	B48GP	598333
S7	A1145F	K4	755U	320404	P1098E	593197	B49-P	599045
S8	1145F	K7	1179A	320405	S1098H	593197	B49-PC	599045
S9	A1145E	91E	A1179E	320470	P1098J	593197	B49GP	599114
SC22	1307W	91F	A1179F	320471	S1098K	593578	Y153-P	599312
T11	O1122BE	91G	A1179G	320514	1768CH	593578	P1786	690222
T11D	O1122BR	91H	A1179H	320514	1769CH	593578	Y153PCHY	690230
T28	T60	91J	A1179J	320514	1770CH	593719	B51-P	690230
T3	O1122A	91K	A1179K	320514	P1770U	593719	B51-PC	690230
T32	PH32	91L	A1179L	320515	S1770U	593719	B51GP	690231
T37	TA16	91N	A1179N	320516	1170LN	593746	B64-P	690231
T3NR	1550	91P	A1179P	320516	1766LN	593746	B64-PC	690503
T4	O1122R	91R	A1179R	320516	1127FD	593746	B64GP	690552
T40	1043B	91S	A1179S	320516	1127ME	593942	B63-P	690552
T43	SC1098X	91T	A1179T	320516	1127TB	593942	B63-PC	690554
T44	X132	91U	A1179U	320560	1970AM	593942	B63GP	690554
T48	HG3	91V	A1179V	320561	S1970AM	594032	B50-P	690556
T49	SW3	BEST		320588	H1098A	594032	B50-PC	690556
T50	SW2	BEST	ILCO	320588	P1098A	594032	B50GP	690898
T51	SW1	1A1A1	A1114A	320589	O1098B	594145	Y154PCHY	690898
T52	1180S	1A1B1	A1114B	320589	S1098B	595198	B45-P	
T55	101AM	1A1C1	A1114C	320652	H1098C	595198	B45-PC	CCL
T55A	102AM	1A1D1	A1114D	320652	P1098C	595293	Y154PJP	4193C-AR
T6	L1054B	1A1E1	A1114E	320653	O1098D	595311	B44-P	4193C-BL
T6B	1069	1A1F1	A1114F	320653	S1098D	595311	B44-PC	4193C-BR
X14	1176D	1A1G1	A1114G	320734	1098DB	595312	B78-P	4193C-WL
X16C	T61B	1A1H1	A1114H	320842	1098GX	595312	B78-PC	4195C-BR
X18P	S48HF-P	1A1J1	A1114J	320885	X1199J	595312	B78GP	4197 1/4-YB
X5	1137B	1A1K1	A1114K	320885	1702K	595313	B77-P	5860-KM
X7	XPA2	1A1L1	A1114L	320885	1703K	595313	B77-PC	5860-KS
Y1	997EB	1A1M1	A1114M	320885	1704K	595313	B77GP	5861-KM
Y10	O1122AR	1A1N1	1A1N2	320885	1705K	596504	P1794	5861-KS
Y15	997GX	1A1TB1	1A1TB2	320885	1706K	596508	Y157PJP	5862C-R34
Y2	R997EB	1A1Q1	A1114Q	320885	D1707K	596756	H65F	5864-JL
Y30	YH20	1A1R1	A1114R	320885	1764P	596757	H66M	5865-JL
Y30D	YH6	1A1TB1	A1114TB	320885	1767CH	596758	1193FD	5865-JR
Y35/Y35P/Y40	HD57	1A1TC1	1A1TC1	320885	1767DT	596758	H67F	5865-JS
Y35C	HD56	1A1TD1	1A1TD1	320944	H1098NR	596807	K1994	5865-JVL
Y36	X84	1A1TE1	1A1TE1	321106	1098XL	596862	DA37-P	5865-JVR
Y36C	HD63	1APWA1	1A1WA1	321202	S1167FD	596862	X242	8618C-CL
Y37	X103	1APWB1	1A1WB1	321207	1167FD	597158	Y157PNEONY	8618C-CR
Y38	KA12	1APWC1	1A1WC1	321212	S1181FD	597253	B92GP	8618C-CR
Y39	X87	1APWD1	1A1WD1	321219	1181FD	597500	B89-P	8618C-R1
Y40C	X120	1APWE1	1A1WE1	321233	X92	597500	B89GP	8618C-R12
Y41C	X118	1APWG1	1A1WG1	321256	X150	597638	H75F	8618C-R14

CROSS REFERENCE



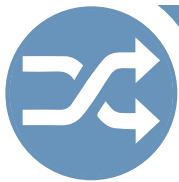

CROSS REFERENCE

	CHICAGO	ILCO	COLE	ILCO	COLE	ILCO	COLE	ILCO
	K19	1041DH	AU8	X139	CLB5	1573E	EL8	S1096JN
	K2	1041D	B1	1098GM	CLB6	1573F	EN13	X22
	K20	H1041T	B1	1098M	CLB7	1581G	EN13	62FT
	K21	CC21	B10	H1098LA	CLB8	1581H	EN15	MG1
	K23	C1041C	B11	O1098LA	CO1	1000	EN2	62FS
	K29	CC29	B44	P1098E	CO10	1000G	ES9	1503
	K2W	1041N	B45	S1098H	CO10	X1000G	F5	FT38
	K30	CC30	B46	P1098J	CO105	L1003M	F51	FT37
	K35/K46	1041E	B47	S1098K	CO106	1003M	F77	FT6R
	K35M	C1041J	B48	P1098A	CO107	1000X	FA3	A1054WD
	K37	C1041L	B49	S1098B	CO12	1000T	FO153	61VW
	K38	C1041N	B5	1098DB	CO17	1000F	FO417	VW67S
	K39	C1041P	B50	P1098C	CO19	X1000F	FO453	DA20
	K4	1041G	B51	S1098D	CO2	1000AB	FR2	F44
	K40	1041DE	B53	X143	CO26	1000V	GE1	VW67
	K43	1041DV	B54	X154	CO3	1001EB	GE2	FT5R
	K44	R1041DV	B55	X145	CO33	1001E	GE26	PO5
	K4L	1041GA	B56	X146	CO35	R1001EE	H12	1125H
	K4R	1041GR	B61	X168	CO37	1001EL	H26	1127ES
	K4W	C1041DN	B63	P1098CV	CO5	1001	H27	1127DP
	K4XV	1041GB	B64	P1098WC	CO54	1000FR	H32	S1167FD
	K5	1041T	B65	X184	CO54	X1000FR	H33	1167FD
	K5K	S1041T	B67	S1098WD	CO60	R1000T	H54	1184FD
	K5M	C1041A	B68	P1099	CO61	1000P	H56	1186TS
	K6	1041M	B69	X180	CO63	R1001EG	H6	1125D
	K7	1041K	B74	X198	CO64	X1001KC	H60	1190LN
	K9	1041TR	B77	P1098EV	CO65	1001EH	H67	1193FD
	KP1	1041Y	B78	P1098WE	CO66	A1001EH	H7	X20
	KP12	C1041R	B79	S1098WH	CO67	1011GH	H70	X231
	KP13	C1041T	B86	P1106	CO67	1001GH	H75	1196FD
	KP14	C1041JB	B88	P1108	CO7	1001EN	H76	X244
	KP16	C1041YR	BA2	1021BA	CO8	1000K	H78	1196CM
	KP17	C1041TR	BE2	A1114A	CO89	A1001ABM	HD103	X214
	KP18	C1041SR	BM2	X59	CO9	1000KC	HD70	X71
	KP2	SC1041R	BM3	X144	CO90	L1001ABM	HD82	X129
	KP3	SC1041S	BN1	K1122D	DA21	X7	HD90	X181
	KP4	SC1041T	BN3	L1098M	DA22	X6	HD91	X182
	KP6	SC1041YR	BN3	L1054M	DA23	DA23	HO3	1170B
	KP7	SC1041TR	BN7	K1122N	DA24	X114	HR1	1014C
	KP8	SC1041SR	BO1	R1003M	DA25	X123	HY12	X232
	KP9	S1041JA	C2	1040	DA26	X124	HY13	X235
		COLE	C3	1040A	DA31	X210	HY14	X236
		COLE	C5	1040C	DE1	1054KD	HY4	X187
		ILCO	C6	R1040C	DE3	D1098X	HY5	X196
	AB1	AB62C	C7	CH4	DE7	D1054K	HY6	X216
	AM1	1041C	C8	1040E	DE8	D1054KA	IL1	1041H
	AM3	1045	CG1	1041G	EA1	1014	IL8	1043B
	AM4	1046	CG14	1041Y	EA27	1014F	IL9	1043D
	AM6	A1045	CG15	1041T	EA27	X1014F	IN1	X1054F
	AP1	101AM	CG16	1041E	EA3	1013F	IN1	1054F
	AP2	102AM	CG2	1041GA	EL10	C1096CN	IN10	S1096B
	AP3	103AM	CG4	1041GR	EL10	1096C	IN10	1054FN
	AP4	104AM	CG6	1041N	EL11	C1096LN	IN2	1054X
	AP5	100AM	CH6	A1015M	EL11	1096L	IN2	1054
	AR1	1179	CL1	1023	EL15	L1096CN	IN24	X1054JA
	AR2	755	CLB1	1573A	EL16	S1096FL	IN29	1054UN
	AR3	760	CLB2	1573B	EL16	1096FL	IN3	X1054K
	AR3	765	CLB3	1573C	EL17	S1096FM	IN3	1054K
	AR4	1179A	CLB4	1573D	EL17	1096FM	IN33	1054MTV
	AR4	PA6						
	AR6							
	AU6							

SEC 10
PG 404





COLE	ILCO	COLE	ILCO	COLE	ILCO	COLE	ILCO	COLE	ILCO
IN34	1054TW	RO3	1069B	SK1	R1001EN	Y111	998GST		
IN35	1054DL	RO3	N1069B	SL1	1120D	Y12	O1122A		
IN8	L1054B	RO4	1069FL	SL15	1120F	Y13	O1122R		
JA64	X10	RO5	1069E	SL17	1074B	Y131	X1199G	CORBIN	ILCO
JA74	X36	RO6	1069-5Y	SL18	1120H	Y133	X1199AR	L3-5PIN-10	1011-L3
JA77	X44	RO7	1069G	SL20	1120S	Y14	H1122FR	L3-6PIN-10	A1011-L3
JA80	HD71	RO9	1069W	SL24	1120J	Y14	O1122AR	L3-7PIN-10L	1011-L3
K1	1079	RT15	X12	SQ1	192	Y141	1764S	L41-5PIN-10	1011-L41
K2	1079B	RT22	X116	T1	1141	Y144	O1122BE	L41-6PIN-10	A1011-L41
KW1	S1176	RT30	X147	T2	H1122M	Y145	999B	L41-7PIN-10	L1011-L41
KW1	1176	RU1	1011	T4	1141E	Y149	S1770U	L4-5PIN-10	1011-L4
KW10	A1176ST	RU13	N1011S	T4	1141GE	Y152	P1770U	L4-6PIN-10	A1011-L4
L1	1004	RU13	1011S	T7	1141F	Y153	P1786	L4-7PIN-10L	1011-L4
L4	1004A	RU16	A1011P	TO20	T61C	Y154	P1789	SY4-L2-6	CB11
L5	1004AL	RU18	A1011PZ	TO22	T61F	Y155	P1793	W-L2-6	CB9
M1	1092	RU20	1011D1	TO25	TR25	Y157	P1794	X1-057-6	R1001EM
M10	1092N	RU21	A1011D1	TO33	X137	Y159	P1795	X1-067-5	1001ES
M11	1092H	RU22	1011GJ	TO37	X159	Y1E	999N	X1-077-5	R1001ES
M12	1092D	RU4	1011P	TO39	X151	Y2	999A	X1-077-6	R1001ET
M13	1092J	RU5	1011A	TO40	X174	Y3	C999	X1-27-5	1001EB
M2	1092B	S1	1009	TO47	X217	Y34	997DA	X1-27-6	1001EA
M3	1092VM	S16	N1007KMB	TO53	X223	Y4	998	X1-27D2-6	R1001EP
M60	1092-6000	S22	O1007LA	VL12	VO62	Y52	997E	X1-57A1-5	R1001EF
M70	1092-7000	S23	O1007LB	VL4	X30	Y54	O997E	X1-57A1-6	R1001EE
M9	1092-900	S24	O1007LC	VL5	X29	Y57	J997M	X1-57A1-7	A1001MF
MD17	MD1054K	S25	O1007LE	VL6	X80	Y7	996M	X1-57A2-6	1001MB
ME62	MB15	S26	O1007LF	VR1	VR91R	Y78	998GA	X1-57A2-7	A1001MB
ME63	MB16	S27	O1007LG	VR2	VR91	Y79	998GB	X1-57B1-6	1001MA
ME66	MB18	S28	O1007LJ	VR3	VR91B	Y80	998GC	X1-57B1-7	A1001MA
MIT1	X176	S29	O1007LK	VR4	VR91A	Y81	998GD	X1-57B2-6	R1001ED
MZ10	X27	S3	1010	VR5	VR91CR	Y82	998GE	X1-67-5	1001EN
MZ12	X1	S30	O1007LL	VR6	L67A	Y83	998GF	X1-67-6	1001EG
MZ15	X131	S31	N1007RMA	VR7	VR91AR	Y84	998GG	X1-67-7	1001EL
MZ19	X201	S32	N1007RMB	VW10	V61VW	Y85	998GH	X1-67A1-6	A1001MJ
MZ27	X222	S4	1010U	VW23	X9	Y87	998R	X1-67A1-7	B1001EJ
MZ4	X4	S4	O1010	VW24	VW71	Y89	998VC	X1-67B2-6	A1001HP
MZ5	X5	S43	1010N	VW25	VW71A			X1-77-5	R1001EN
MZ9	X26	S44	L1010N	VW32	X53			X1-77-6	R1001EG
NA10	1064D	S45	O1007RA	VW32	X21	98	1002B	X1-77-7	R1001EL
NA12	1069LB	S46	O1007RB	VW37	X203	98.25	1002A	X1-77A1-5	R1001MJ
NA14	1069L	S47	O1007RC	VW42	X110	98.5	1002	X1-97-5	1001
NA5	R1064D	S48	O1007RE	VW9	U61VW	990.25	CB2	X1-97-6	1001AB
NA6	R1064E	S49	N1007KMC	W1	1071	993.25	CB3	X1-97-7	1001A
NC2	1083H	S7	1007	WE1	1123	6901	CB12	X1-99-5	1000
NH1	1177N	SB12	X31	WK1	1175N	6903	CB1	X1-99-6	1000AB
OL1	1171	SC1	1145	WK1	1175	6906	CB7	X1-99-7	1000A
P1	1016	SC10	A1145J	WR1	X1054WA	K1-80-5	1001GH	Z1-059A-5	1001AM
P2	1016N	SC11	1145E	WR2	1054WB	L12-5PIN-10	1011-L12	Z1-059A-6	A1001AM
PA1	1528	SC20	A1145L	WR5	A1054WB	L12-6PIN-10	A1011-L12	Z1-059A-7	L1001AM
PA2	1528R	SC22	1307W	XL7	1180S	L12-7PIN-10	L1011-L12	Z1-059AB-5	1001ABM
PH1	A1	SC4	1145A	Y1	999	L1-5PIN-10	1011-L1	Z1-059AB-6	A1001ABM
PR6	X32	SC6	1307A	Y101	L1122A	L1-6PIN-10	A1011-L1	Z1-059AB-7	L1001ABM
PR7	PO7	SC7	A1145F	Y103	O1122B	L1-7PIN-10L	1011-L1	Z1-059AD-5	1001GRM
PZ1	PZ1	SC8	A1145H	Y104	O1122BR	L2-5PIN-10	1011-L2	Z1-059AD-6	A1001GRM
RA3	S1970AM	SC9	A1145E	Y105	O1122C	L2-6PIN-10	A1011-L2	Z1-059AD-7	L1001GRM
RA4	1970AM	SE1	1022	Y106	X16	L2-7PIN-10L	1011-L2	Z1-059B2-6	A1001DH
RO1	1069	SE2	O1022	Y107	X121	L34-5PIN-10	1011-L34	Z1-059B-5	1001BM
RO10	1069-5X	SE8	1022AB	Y109	1132	L34-6PIN-10	A1011-L34	Z1-059B-6	A1001BM
RO14	1069YM	SF7	1049E	Y11	O1122	L34-7PIN-10	L1011-L34	Z1-059B-7	L1001BM

CROSS REFERENCE



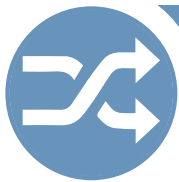

CROSS REFERENCE

CORBIN

ILCO

Z1-059C-5	1001CM
Z1-059C-6A	1001CM
Z1-059C-7	L1001CM
Z1-059CD-5	1001CDM
Z1-059CD-6	A1001CDM
Z1-059CD-7	L1001CDM
Z1-059D-5	1001DM
Z1-059D-6A	1001DM
Z1-059D-7	L1001DM
Z1-59A1-5	1001AH
Z1-59A1-6	A1001AH
Z1-59A1-7	L1001AH
Z1-59A2-5	1001FH
Z1-59A2-6	A1001FH
Z1-59A2-7	L1001FH
Z1-59B1-5	1001BH
Z1-59B1-6	A1001BH
Z1-59B1-7	L1001BH
Z1-59B2-5	1001DH
Z1-59B2-7	L1001DH
Z1-59C1-5	1001C1
Z1-59C1-6	A1001C1
Z1-59C1-7	L1001C1
Z1-59C2-5	1001C2
Z1-59C2-6	A1001C2
Z1-59C2-7	L1001C2
Z1-59D1-5	1001D1
Z1-59D1-6	A1001D1
Z1-59D1-7	L1001D1
Z1-59D2-6	A1001D2
Z1-59D2-7	L1001D2
Z1-60-5	1001EH
Z1-60-6	A1001EH
Z1-60-7	L1001EH
Z1-62A1-6	1001A1
Z1-62A2-6	1001A2
Z1-70-6	A1001EHR

CURTIS

CURTIS

ILCO

2	2B
3	7B
5	45B
7	25B
13	9B
16	49B
17	12B
20	17B
27	19B
29	66B
33	8B
39	56B
40	3B
47	71B
48	78B
49	79B

CURTIS	ILCO	CURTIS	ILCO	CURTIS	ILCO	CURTIS	ILCO
50	5B	305	1306A	B44	P1098E	BE7	A1114F
56	6B	305	S1306A	B45	S1098H	BE8	A1114FM
60	1B	306	1243D	B46	P1098J	BE9	A1114G
63	67B	308	1222B	B47	S1098K	BM1	WT3
67	136SB	308	1093	B48	H1098A	BM3	X144
73	92B	313	1222E	B48	P1098A	BN1	K1122D
74	91B	314	1028A	B49	O1098B	BN7	K1122N
106	84B	322	1084	B49	S1098B	BO1	R1003M
107	24B	322	1226	B5	1098DB	BV4	1036S
108	23B	337	1309	B50	H1098C	BV5	1036U
109	21B	342	1425	B50	L1098C	BX2	1558
112	34B	345	1323	B50	P1098C	BX3	1594
115	22BB	406	1286E	B51	O1098D	CA10	A1170D
134	27B	407	R1286E	B51	S1098D	CA9	A1170C
202	1225BL	411	1286C	B52	X154	CB2	CH4
202	1270B	412	N1286	B53	X143	CB3	CH5
204	O1215	415	N1286R	B55	X145	CB4	CH6
205	1215B	421	1286B	B56	X146	CB5	CH7
206	1215A	516	1233M	B57	X158	CB6	CH8
208	1211B	525	T44	B59	X162	CG1	H1041T
210	1417A	543	1416	B61	X168	CG1	1041G
213	1422	573	70S	B62	P1098AV	CG13	1041FE
215	1270D	603	1147	B63	P1098CV	CG16	C1041C
215 1/2	1417	606	1148	B64	P1098WC	CG16	C1041B
215	1225PL	A71 1/22	1007CB	B67	S1098WD	CG16	1041T
220	1217D	AA1	H61VR	B68	P1099	CG17	1041Y
223	1225A	AA2	X51	B69	X180	CG17 1	SC1041YR
226	1217	AA3	X50	B70	X184	CG18	C1041R
233	O1225N	AM1	1041C	B72	X192	CG18 1	SC1041R
233 1/2	1427	AM3	1045	B74	X198	CG18 3	SC1041TR
239	1370	AM3	1046	B77	P1098EV	CG19	1041DC
242	1332	AM4	1041CE	B78	P1098WE	CG2	1041GA
242	1332S	AM5	1046A	B79	S1098WH	CG20	C1041DN
242 1/2	1213AH	AM7	A1045	B80	X225	CG22	1041E
243	1224L	AP1	101AM	B84	P1101	CG23	C1041J
243 1/2	1225G	AP2	102AM	B85	S1105	CG24 3	SC1041SR
244	1270	AP3	103AM	B86	P1106	CG26	C1041L
245	1095A	AP4	104AM	B87	K1994	CG27	C1041P
245	1270A	AP5	100AM	B88	P1108	CG27 1	S1041T
249	1213A	AR1	1179	B89	P1107	CG29	1041TR
251	1033A	AR2	750	B90	1588	CG3	1041GB
251	1242L	AR2	755	B91	P1111	CG31	C1041A
252	1426	AR3	760	B91PH	B91-P	CG33	1041FG
254	1303	AR3	765	B92	P1109	CG34	1041DH
254	1303S	AR4	1179A	B93	P1112	CG35	1041M
257	1225E	B1	1098GM	B96	P1110	CG37	CC21
258	1321	B1	1098M	BA1	1021B	CG38	1041DV
259	1214	B10	L1098LA	BA2	1021BA	CG39	R1041DV
261	1221AL	B10	H1098LA	BC3	R7DC	CG4	1041GR
262	1270C	B102	P1113	BD1	63F	CG41	S1041JA
264	O1213	B102-R	B102-P	BD2	H62VG	CG43	1041DE
265	1213AS	B11	O1098LA	BD3	62VH	CG44	R1041DC
268 1/2	1222L	B2	H1098M	BE1	1114	CG45	C1041YR
270	1217A	B24	H1098X	BE10	A1114H	CG46	C1041TR
279	O1221L	B3	1098L	BE2	A1114A	CG47	C1041SR
280	O1223L	B31	1764S	BE3	A1114B	CG5	1041K
290	1210A	B31	1759P	BE4	A1114D	CG6	1041N
302	1206A	B31	D1759L	BE5	A1114E	CG7	1041X
304	1028D	B4	1098X	BE6	A1114C	CH1	1015





CURTIS	ILCO	CURTIS	ILCO	CURTIS	ILCO	CURTIS	ILCO	CURTIS	ILCO
CH10	A1015N	CO41	1000P	DA37PH	DA37-P	FO202	VR91AR		
CH11	A1015P	CO42	R1000T	DA38	X243	FO203	VR91B		
CH12	A1015Q	CO43	1001K	DA38PH	DA38-P	FR1	TE3		
CH13	A1015R	CO44	1001MA	DC2	X54	FS1	FU2		
CH14	A1015S	CO45	1001MB	DC3	X121	FT11	LA7	CURTIS	ILCO
CH15	A1015T	CO5	1001	DE1	1054KD	FT16	61E	H76PH	H76-P
CH16	A1015U	CO54	1000FR	DE2	D1098B	FT16	SE1C	H78	1196CM
CH17	A1015V	CO54 1	X1000FR	DE4	D1098X	FT16	61TS	H78PH	H78-P
CH18	A1015W	CO57	A1001HP	DE5	A1054KD	FT19	61D	H79	1196V
CH19	A1015X	CO6	1001AB	DE6	D1054K	FT2	F91E	H9	1125G
CH20	A1015Y	CO60	A1001MF	DE8	D1054KA	FT22	61F	HD103	X214
CH3	1015C	CO61	A1001MB	DO1	L54K	FT28	F91EH	HD104	X215
CH5	1015M	CO62	R1001EG	DO2	22PO	FT28	F91ES	HD109	X265
CH6	A1015M	CO63	1000X	DO3	P54F	FT29	F91FS	HD23	HD11
CH7	A1015C	CO64	A1001MA	EA1	1014	FT29	F91FH	HD23	67LD
CH9	A1015L	CO68	S1000V	EA10	L1014D	FT29	F91F	HD30	67LB
CL1	1023	CO69	A1001MJ	EA12	1014A	FT30	F91GS	HD32	HD32
CL2	1023A	CO7	1001EN	EA13	1014DX	FT30	F91GH	HD37	HD12
CM1	1040B	CO71	1001EJ	EA13	1014D	FT30	F91G	HD38	HD10
CM2	1040	CO75	X1001KC	EA14	1014DA	FT31	F91HH	HD52	HD43
CM3	1040A	CO77	S1000X	EA27	1014F	FT31	F91H	HD67	X38
CM4	1040C	CO8	1000K	EA27	X1014F	FT32	F91C	HD69	X44
CM5	R1040C	CO83 1	A1001MJR	EA3	1013F	FT33	F91CR	HD70	HD70
CM6	1040E	CO85	1001DA	EA32	O1014J	FT36	F44	HD71	HD71
CM7	R1040E	CO87	1001GRM	EA35	1014K	FT37	FT37	HD73	X58
CO1	1000	CO88	A1001EH	EA36	1014DB	FT38	FT38	HD74	HD63
CO10	X1000G	CO89	A1001GRM	EA47	O1014S	FT39	NE9	HD75	X138
CO10	1000G	CO9	1000KC	EA8	1013DL	FT39	NE20	HD80	X129
CO101	1001MK	CO91	A1001AH	EC1	EX1	FT43	X109	HD81	X130
CO102	A1001C2	CO92	A1001FH	EL1	1096C	GF1	H62FD	HD84	HD59
CO103	1003A	CO93	A1001AM	EL10	C1096CN	GR1	1524	HD90	X182
CO105	L1003M	CO94	A1001BH	EL11	C1096LN	H10	1125H	HD90PH	HD91-P
CO106	1003M	CO95	A1001DH	EL12	S1096JN	H10	1125F	HD91	X181
CO107	A1001D1	CO97	1001GH	EL13	X1054JK	H19	1761B	HD91PH	HD90-P
CO108	A1001D2	CO98	A1001C1	EL14	1096EN	H26	1127ES	HD92	X183
CO110	R1001EK	CS1	1178	EL15	L1096CN	H27	1127DP	HD95	X191
CO12	1000T	CU2	1181C	EL16	1096FL	H50	S1167FD	HD96	X193
CO13	1000A	CY1	CE1	EL17	1096FM	H51	1127TB	HD98	X195
CO17	1000F	DA12	DT9	EL18	1096FS	H51	1127ME	HD99	X204
CO18	XO1000F	DA13	DT10	EL2	1096	H51	1167FD	HL3	X95
CO18 1	O1000GX	DA14	DT11	EL3	1096L	H52	S1181FD	HL4	X96
CO19	X1000F	DA15	DT12	EL5	EB1096K	H53	1181FD	HO1	1170B
CO2	1000AB	DA16	DT13	EL5	X1054JA	H54	1184FD	HR1	1014C
CO21	1000H	DA17	DT14	EL8	H1054B	H55	1185FD	HU1	1020
CO22	1000HL	DA18	DT6	ER1	1119	H56	1186TS	HY14	X236
CO23	R1000HL	DA19	DT16	F2	1073	H59	X202	HY14PH	HY14-P
CO26	1000V	DA20	DA20	F8	1073K	H6	1125D	HY2	X160
CO27	R1000V	DA21	X7	FA1	1054WC	H60	1190LN	HY3	X187
CO28	1001A	DA22	X6	FA2	A1054WC	H62	1191ET	HY3PH	HY4-P
CO3	1001EB	DA23	DA23	FA3	A1054WD	H65	X221	HY4	X196
CO30	1001C	DA24	X114	FC1	BR20	H67	1193FD	HY4PH	HY5-P
CO33	1001E	DA27	X123	FC2	X20	H70	X231	HY6	X216
CO34	R1001ED	DA27PH	DA25-P	FC4	X36	H70PH	H70-P	HY8	X232
CO35	R1001EE	DA28	X124	FC5	X4	H71	1195FD	HY8PH	HY12-P
CO35 1	R1001EF	DA32	X227	FC6	X54	H71PH	H71-P	HY9	X235
CO351	CB6	DA34	X237	FC7	X86	H74PH	1188LN-P	HY9PH	HY13-P
CO36	1001EG	DA34PH	DA34-P	FC8	FC8	H75	1196FD	IL1	1041H
CO37	1001EL	DA35	X238	FC9	FC9	H75PH	H75-P	IL10	1043D
CO4	1001EA	DA37	X242	FO201	VR91	H76	X244	IL13	ILL1

CROSS REFERENCE



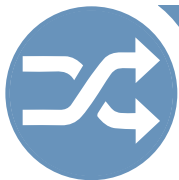

CURTIS

IL14
 IL15
 IL17
 IL2
 IL4
 IL5
 IL7
 IL9
 IN1
 IN12
 IN14
 IN17
 IN18
 IN2
 IN2
 IN20
 IN22
 IN23
 IN24
 IN25
 IN26
 IN27
 IN28
 IN29
 IN3
 IN32
 IN33
 IN34
 IN4
 IN5
 IN8
 IV1
 JA1
 JA2
 K1
 K2
 K3
 K4
 KA17
 KA20
 KA21
 KA22
 KA23
 KA24
 KA25
 KA26
 KA27
 KA28
 KA6
 KA7
 KK1
 KK2
 KK3
 KU1

ILCO

ILL2
 1043C
 1043E
 1041P
 1041S
 S1042Z
 S1042ZS
 1043B
 1054F
 1125A
 1054N
 1054P
 X1054F
 1054X
 1054
 X1054K
 X1054AR
 X1054BK
 K1054B
 K1122B
 L1054M
 K1122C
 1054FN
 1054UN
 1054K
 H1054S
 1054MT
 1054TW
 1054LB
 1054R
 L1054B
 X155
 FT5R
 X177
 1079
 1079B
 1079AB
 1079A
 KW14R
 X254
 X255
 X256
 X257
 X258
 X259
 X260
 X261
 X262
 X23
 X24
 X233
 X240
 X253
 1539

CURTIS

KU2
 KW1
 KW10
 KW2
 KW4
 KW5
 L1
 L10
 L10
 L13
 L14
 L2
 L21
 L22
 L3
 L4
 L5
 LF1
 LF2
 LUV1
 M1
 M10
 M11
 M12
 M13
 M15
 M16
 M2
 M3
 M4
 M4
 M6
 M7
 M70
 M8
 M9
 MB33
 MB34
 MB35
 MD17
 MG1
 MR2
 MT1
 MT3
 MT5
 MT5PH
 MT6
 MZ10
 MZ12
 MZ14
 MZ14PH
 MZ15
 MZ16
 MZ18
 MZ20
 MZ21
 MZ25
 MZ27
 MZ30

ILCO

1540
 S1176
 A1176ST
 1176D
 1176
 A1176
 1004
 1004M
 1004JA
 1004N
 H1004A
 1005
 1004SN
 1004AR
 1006
 1004A
 1004AL
 X13
 LF2
 P1098V
 1092
 1092N
 1092H
 1092D
 1092DS
 1092R
 1092NR
 1092B
 1092VR
 1092VM
 1092V
 1092VA
 1092C
 1092-7000
 1092DD
 1092E
 MB18
 MB15
 MB16
 MD1054K
 MG1
 MR2
 X176
 X224
 X245
 MIT4-P
 X263
 X27
 X60
 X131
 MZ13-P
 X178
 X188
 X201
 X199
 X200
 X206
 X222
 X247

CURTIS

MZ31
 MZ9
 N1
 NA1
 NA12
 NA12
 NA14
 NA26
 NA6
 NA6
 NC1
 NH1
 NH1
 NH2
 OP11
 OP15
 OP19
 OP8
 P1
 P2
 PA2
 PA5
 PA6
 PA7
 PA8
 PE1
 PL7
 PP1
 PU10
 PU13
 R1
 R2
 R3
 RA1
 RA2
 RA3
 RA4
 RA7
 RD4
 RE1
 RE2
 RN16
 RN17
 RN23
 RN24
 RN25
 RN27
 RN30
 RN32
 RN33
 RN5
 RN9
 RO1
 RO3
 RO4
 RO5
 RO7
 RO8
 RS1
 RS2

ILCO

X249
 X26
 1017
 1064
 1069LA
 1069LB
 1069L
 R1064E
 R1064D
 1083
 1177N
 1177
 1177A
 OP11
 YM6
 U62VP
 62PD
 1016
 1016N
 PO5
 PA5
 PA6
 X32
 X88
 1034
 DM4
 7DC
 1866-10
 1866-13
 1140
 1146
 1140G
 1098NR
 H1098NR
 S1970AM
 1970AM
 1584
 1069HN
 1019
 1019A
 LM1
 NE18
 X12
 X116
 X92
 X150
 X147
 X175
 X171
 RE61N
 RE61XR
 1069
 S1069H
 1069FL
 1069M
 1069G
 1069-5Y
 M64
 H64

CURTIS

RS3
 RU1
 RU16
 RU3
 RU4
 RU4
 RU44
 RU45
 RU46
 RU7
 RV1
 RV4
 S1
 S10
 S16
 S2
 S22
 S22 1/2
 S23
 S24 1/2
 S25
 S25 1/2
 S26
 S27
 S27 1/2
 S29
 S29 1/2
 S3
 S30 1/2
 S31
 S32
 S4
 S5
 S51
 S57
 S58
 S58 1/2
 S6
 S68
 S69
 S70 1/2
 S73
 S73 1/2
 S74 1/2
 S75 1/2
 S76
 S76 1/2
 S77
 S77 1/2
 S82
 S82 1/2
 SA1
 SA3
 SB10
 SB11
 SC1
 SC10
 SC11
 SC12

ILCO

MR1
 1011
 A1011P
 1011B
 N1011P
 1011P
 1011GH
 1011D1
 A1011D1
 1011M
 X170
 X239
 1009
 1010B
 N1007KMB
 O1009
 O1007LA
 1007LA
 O1007LB
 1007LC
 O1007LE
 1007LE
 O1007LF
 O1007LG
 1007LG
 O1007LK
 1007LK
 1010
 1007LL
 N1007RMA
 N1007RMB
 O1010
 1009A
 O1007RB
 O1007RK
 O1007RL
 1007RL
 N1007KMA
 1010N
 L1010N
 1007CA
 O1007CE
 1007CE
 1007CF
 1007CG
 O1007CJ
 1007CJ
 O1007CK
 1007CK
 O1007CN
 1007CN
 1047CR
 1047
 X31
 X52
 1145
 A1145F
 1145G
 A1145G

CURTIS

SC13
 SC14
 SC15
 SC16
 SC17
 SC18
 SC19
 SC20
 SC21
 SC22
 SC23
 SC24
 SC26
 SC4
 SC6
 SC7
 SC8
 SC9
 SE1
 SE2
 SK1
 SK2
 SK4
 SL1
 SL16
 SL2
 SL20
 SL24
 SL24
 SL8
 SM1
 SM12
 SQ1
 SR2
 SR8
 SU14
 SU15
 SU17
 SU18
 SU5
 SU6
 SU7
 T1
 T2
 T2
 T3
 T4
 T7
 TR13
 TR17
 TR18
 TR2
 TR20
 TR21
 TR22
 TR23
 TR25
 TR26
 TR27

ILCO

1145H
 A1145H
 1145J
 A1145J
 1145K
 A1145K
 1145L
 A1145L
 A1145CE
 1307W
 1145EF
 A1145EF
 A1145FG
 1145A
 1307A
 1145F
 1145E
 A1145E
 1022
 O1022
 R1001EN
 R1001EM
 R1001EL
 1120D
 1074B
 A1074B
 1120F
 1154L
 1120S
 1074BM
 N63G
 NE19
 192
 X108
 X251
 X179
 X185
 X186
 X241
 X11
 X25
 X87
 1141
 1140P
 H1122M
 1141E
 1141F
 1141GE
 TP3
 T61A
 TR18
 TP1
 T61C
 T61D
 T61E
 T61F
 TR25
 TR26
 TA15





CURTIS	ILCO	CURTIS	ILCO	CURTIS	ILCO	CURTIS	ILCO	DOMINION	ILCO
TR28	X37	VL5	X29	Y208	998TMK	Y9	H1122F		
TR3	TP2	VL6	X80	Y209	998VD	Y91	999CA		
TR33	X137	VO2	185V	Y211	998VE	Y92	Y202		
TR37	X159	W1	1071	Y212	998TA	Y98	1060C		
TR39	X151	WE1	1123	Y213	998TB	YM35	X39	7	Y200
TR40	X174	WE3	1123S	Y214	998TC	YM36	X18	7	1007
TR44	X211	WK1	1175	Y220	999B	YM41	YH39	8	998
TR46	X212	WK2	1175N	Y222	998GL	YM42	YH40	8	1008
TR47	X217	WR1	X1054WA	Y225	998SMK	YM43	X62	9	999
TR5	TP4	WR3	1054WB	Y227	998GST	YM52	X76	9	1009
TR53	X223	WR4	A1054WB	Y234	885BL	YM57	X120	10	1010S
TR6	TA2	WR5	N1054WB	Y236	998VG	YM58	X119	11	1011
TR7	TP6	WS2	FT6R	Y238	998VH	YM59	X117	12	1012
TR9	T61B	WS2	X1	Y239	998VK	YM60	X118	13	1013
UN1	62DK	XL7	1180S	Y240	889A	YM61	YH50	14	1014
UN16	UN16	Y1	X999	Y250	H998GA	YM62	YH51	16	1016
UN17	X17	Y1	999	Y251	H998GB	YM63	X248	19	1019
UN17	62FT	Y10	H1122FR	Y252	H998GC	YS1	X21	22	1022
UN18	62FS	Y101	L1122A	Y3	C999	YS2	X22	23	1023
UN2	62DG	Y102	L1122B	Y3	1047M	YU1	X153	25	25
UN26	X16	Y103	O1122B	Y34	997DA	YU2	X167	26	VA1
UN3	62DP	Y104	O1122BR	Y4	998	DEXTER/MASTER		26.5	VA2
V10	PR1	Y105	O1122C	Y52	997E	DEXTER	ILCO	27	1000AB27
V10	61VW	Y109	1132	Y53	997ER	11	D1098B	31	1031
V11	U61VW	Y11	O1122	Y54	O997E	13	D1098BM	33	1033
V12	V61VW	Y116	998SA	Y55	997G	61	1054KD	34	1034
V13	VW63	Y117	998SB	Y57	J997M	62	D1054KA	36	1036
V14	VW63A	Y118	998SC	Y58	J997MR	63	D1098X	47	1047
V15	62DW	Y119	998SD	Y59	997JA	67	A1054KD	50	50
V17	VW64	Y12	O1122A	Y6	997X	62-B1	DXB1	51	51
V18	63VR	Y120	998SE	Y60	997JB	62-B2	DXB2	54	1054
V19	VW64T	Y121	998SF	Y61	997JC	62-B3	DXB3	62	62
V2	62VW	Y122	998SG	Y62	997JD	62-BM	DXB4	63	63
V23	W62VE	Y123	998SH	Y63	997JE	62-C1	DXC1	67	W67
V24	VW77	Y124	998SK	Y64	997JF	62-C2	DXC2	68	1068
V25	VW67S	Y133	X1199AR	Y64 1/2	997JG	62-C3	DXC3	69	1069W
V26	VW67	Y138	S1767CH	Y64 1/2	997JH	62-CM	DXC4	70	DA2
V27	V27	Y138	1766S	Y64 3/2	997JK	62-D1	DXD1	71	1071
V28	VW71	Y138	1701G	Y7	996M	62-D2	DXD2	72	1072
V29	VW71A	Y138	X1199B	Y78	998GA	62-D3	DXD3	79	1079
V30	X9	Y138	X1199G	Y78 1/2	999GA	62-DM	DXD4	84	1084
V31	X8	Y14	H1122AR	Y79	998GB	62-GM	DXG5	91	1091
V32	X53	Y14	O1122AR	Y79 1/2	999GB	67-B1	DXB10	92	1092
V33	X110	Y149	S1770U	Y80	998GC	67-B2	DXB20	94	94
V35	X139	Y15	999N	Y80 1/2	999GC	67-B3	DXB30	96	1096
V36	X203	Y150	1769CH	Y81	998GD	67-C1	DXC10	115	1115
V5	62VO	Y152	P1770U	Y81 1/2	999GD	67-C2	DXC20	119	1119
V6	62VE	Y153	P1786	Y82	998GE	67-C3	DXC30	123	1123
V9	U62VN	Y154	P1789	Y82 1/2	999GE	67-D1	DXD10	125	1125D
VA1	VA1	Y155	P1793	Y83	998GF	67-D2	DXD20	127	1127
VA2	X122	Y156	1793V	Y83 1/2	999GF	67-D3	DXD30	132	1132
VL1	VO6	Y157	P1794	Y84	998GG	67N	D1054K	137	1137S
VL10	X140	Y158	1794V	Y84 1/2	999GG	DOMINION		138	138
VL10PH	VL8-P	Y159	P1795	Y85	998GH	DOMINION	ILCO	139	139
VL11	NE10	Y2	999A	Y85 1/2	999GH	0	1000	141	1141
VL2	WS2	Y203	998VB	Y86	998GK	1	1	143	1143
VL3	FTA2R	Y204	998TE	Y86 1/2	999GK	1	1001	145	1145
VL3	VO62	Y206	998TG	Y87	998R	2	1002	149	149
VL4	X30	Y207	998TH	Y89	998S	4	1004	155	155

CROSS REFERENCE

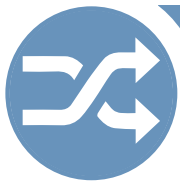

CROSS REFERENCE

	DOMINION	ILCO	DOMINION	ILCO	DOMINION	ILCO	DOMINION	ILCO	
		953	T89	01MD	1001MD	10N	1010N	127J	1127J
		954	T88	01MG	1001MG	10T	1010T	127K	1127K
		970	T73	01MJ	1001MJ	11-04A	1011-04A	127L	1127L
		972	T74	01RM	1001CDM	11-04AS	1011-04AS	127LC	1761LP
		973	T75	02A	1002A	115B	1115B	127LS	1761LS
		2712	2712	02B	1002B	11B	1011B	127M	1127M
		2714	2714	03A	1003A	11D1	1011D1	127ME	1127ME
		4015	4015	03AB	1003AB	11D2	1011D2	127MP	1127MP
		4436	4436	03B	1003B	11D3	1011D3	127MU	1127MU
		5985	T72	03C	1003C	11D4	1011D4	127N	1127N
		5987	T139	03CD	1003CD	11GH	1011GH	127P	1127P
		8446	T41	03D	1003D	11GJ	1011GJ	127T	1127T
		00A	1000A	03M	1003M	11K1	1011K1	127TB	1127TB
		00AB	1000AB	04A	1004A	11K10	1011K10	12A	1012A
		00BH	R1003M	04AL	1004AL	11K11	1011K11	13BF	1013BF
		00F	1000F	04AR	1004AR	11K12	1011K12	13C	1013C
		00FR	1000FR	04KL	1004KL	11K13	1011K13	13DL	1013DL
		00FX	1000FX	04M	1004M	11K2	1011K2	13F	1013F
		00G	1000G	04N	1004N	11K3	1011K3	141E	1141E
		00H	1000H	04R	1004R	11K4	1011K4	141GE	1141GE
		00K	1000K	07A	1007A	11K5	1011K5	141JE	1141JE
		00KC	1000KC	07G	1007G	11K6	1011K6	141JL	1141JL
		00KT	1000XK	07LA	1007LA	11K7	1011K7	141L	1141L
		00T	1000T	07LB	1007LB	11K8	1011K8	143C	143C
		00V	1000V	07LC	1007LC	11K9	1011K9	143D	143D
		00X	1000X	07LD	1007LD	11KM	1011PZ	145CE	1145CE
		00Z	1001EH	07LDH	1007LDH	11M	1011M	145E	1145E
		01A	1001A	07LDM	1007LDM	11MA	1011MA	145EF	1145EF
		01A1	1001AH	07LE	1007LE	11P	1011P	145F	1145F
		01A2	1001FH	07LF	1007LF	11S	N1011S	145FG	1145FG
		01AB	1001AB	07LG	1007LG	11T	N1011T	145G	1145G
		01AM	1001AM	07LH	1007LH	120D	1120D	145H	1145H
		01B1	1001BH	07LHM	1007LHM	120F	1120F	145J	1145J
		01B2	1001DH	07LJ	1007LJ	120G	1120G	145K	1145K
		01BM	1001BM	07LK	1007LK	120H	1120H	145L	1145L
		01C1	1001C1	07LL	1007LL	120J	1120J	14C	1014CE
		01C2	1001C2	07LM	1007LM	120K	1120K	14CM	14CM
		01CM	1001CM	07LN	N1007KMB	120N	1120N	14D	1014D
		01D	1001D	07RA	1007RA	120S	1120S	14DA	1014DA
		01D1	1001D1	07RB	1007RB	122D	1122D	14DB	1014DB
		01D2	1001D2	07RC	1007RC	123A	1123A	14DR	1014DR
		01DA	1001DA	07RD	1007RD	125A	1125A	14DS	1014DS
		01DM	1001DM	07RDH	1007RDH	125C	125C	14DX	1014DX
		01E	1001E	07RDM	1007RDM	125D	D1125	14J	1014J
		01EA	1001EA	07RE	1007RE	125E	1125G	14JE	O1014S
		01EB	1001EB	07RF	1007RF	125G	1125F	14JM	1014JM
		01EG	1001EG	07RG	1007RG	125H	1125H	14JS	O1014JS
		01EL	1001EL	07RH	1007RH	125K	1125K	14K	1014K
		01EN	1001EN	07RHM	1007RHM	125M	1125M	14T	1014F
		01GH	1001GH	07RJ	1007RJ	125X	1125X	15C	1015C
		01GM	1001ABM	07RK	1007RK	127B	1127B	15M	1015M
		01GRM	1001GRM	07RL	1007RL	127D	1127D	167FD	1167FD
		01JB	1000P	07RM	1007RM	127DP	1127DP	16N	1016N
		01JL	1001JL	07RN	N1007RMB	127ES	1127ES"	16NB	1016NB
		01JR	1000JR	08A	1008A	127F	1127F	170B	1170BD
		01K	1001K	09A	1009A	127FD	1127FD	170C	1170B
		01MA	1001MA	10A	1010SA	127FL	1127FL	170CJ	1170CJ
		01MB	1001MB	10F	V91N	127FR	1127FR	170CL	A1170B
		01MC	1001MC	10M	1010M	127H	1127H	170D	1170D





DOMINION	ILCO	DOMINION	ILCO	DOMINION	ILCO	DOMINION	ILCO	DOMINION	ILCO
170E	1170E	3916-21	3916-21	54FL	54FL	611B	1211B		
170S	170S	3916-22	3916-22	54G	1054G	615A	1215A		
170T	170T	41A	104AM	54K	1054K	615B	1215B		
176D	1176D	41AB	103AM	54KD	1054KD	617GL	617GL		
17B	1017B	41AC	101AM	54KP	54KP	617J	617J	DOMINION	ILCO
17BB	1017BB	41AD	102AM	54LB	1054LB	617JL	617JL	62DA	62DA
17M	17B	41AM	100AM	54M	54M	61B	61B	62DB	62DB
191A	191A	41B	1043B	54N	1054N	61D	61D	62DC	62DC
191B	VR91B	41C	1041C	54P	1054P	61E	61E	62DE	62DE
191C	VR91CR	41CK	1041CK	54TW	1054TW	61F	61F	62DF	62DF
192B	192B	41CM	1041CE	54UN	1054UN	61G	61G	62DG	62DG
199C	199C	41D	1041D	5F	5F	61GA	61GA	62DH	62DH
199D	1199D	41DC	1041DC	5M	Y8	61H	61H	62DG	62DG
199DR	1199DR	41DE	1041DE	60.B9	60.B9	61J	61J	62DK	62DK
199E	1199E	41DH	1041DH	60.CD	60.CD	61JD	61JD	62DM	62DM
19A	1019A	41DV	1041DV	60.D	60.D	61K	61K	62DN	62DN
19D	1019D	41E	1041T	60.GH	60.GH	61N	61N	62DO	62DO
19R	1019R	41F	C1041J	60.I9	60.I9	61NA	61NA	62DP	62DP
19XL	1019XL	41FD	41FD	60.IK	60.IK	61NC	61NC	62DR	62FS
1N	1N	41FE	1041FE	60.LM	60.LM	61P	61P	62DS	62DS
22EZ	1177N	41FG	1041FG	60.S9	60.S9	61PC	61PC	62DT	BR9
22L	1022AB	41G	1041G	600B	T77	61PD	61PD	62DV	B62DV
22M	22M	41GA	1041GA	606A	1206A	61PE	61PE	62DW	62DW
22NE	1177	41GB	1041GB	606AH	606AH	61PS	61PS	62DX	62DX
22PO	22PO	41GR	1041GR	606L	606L	61Q	61Q	62DY	VW64T
22W	AR1-PC	41H	1041H	606LH	606LH	61SA	BR5	62E	62E
22W	1179	41J	C1041N	60C	1060C	61SB	BR7	62EV	62EV
23A	1023A	41JA	SC1041R	60HA	60HA	61SC	BR6	62F	KE4
23M	23M	41JB	SC1041S	60HB	60HB	61T	61T	62FD	62FT
25C	RO91R	41K	1041K	60HR	60HR	61TS	61TS	62FE	62FE
25V	25V	41M	1041M	60HU	HU5	61V	VG2	62FG	62FG
28A	1028A	41N	1041N	60UA	60UA	61VT	61VT	62GE	GE8
28BM	28BM	41P	1041P	60UF	60UF	61W	61W	62GP	GIP91
28DC	1028DC	41S	1041S	60UG	60UG	61X	61X	62H	62H
28DD	1028DD	41T	1041E	60VF	60VF	61Y	WA91W	62HA	62HA
28DS	1028D	41UN	R1096EN	60VF9	60VF9	61Z	ZKN1	62HB	62HB
28N	1028NN	41W	1041W	60VG	60VG	621A	621A	62HC	62HC
28P	1028P	41WA	1042A	60VG9	60VG9	621AL	1221AL	62HD	62HD
2M	2B	41WC	1041WC	60Z1	60Z1	621L	1221L	62HE	X28
2N	2N	41X	1046	60Z10	60Z10	623S	623S	62HF	62HF
318ST	T105	41Y	1041Y	60Z11	60Z11	624F	1224F	62HG	62HG
33A	1033A	42B	1043D	60Z12	60Z12	624L	1224L	62HL	VA4
33C	33C	42Z	1042Z	60Z13	60Z13	625A	1225A	62J	VA6
33G	1033G	43C	1043C	60Z14	60Z14	625D	1225D	62JA	VA7
33K	33K	43E	1043ED	60Z16	60Z16	625DH	625DH	62JB	62JB
33N	1033N	43F	1043F	60Z17	60Z17	625E	1225E	62JT	62JT
33NO	33NO	47A	1047A	60Z18	60Z18	625EH	625EH	62K	ZE91G
33Z	ZN1	47CR	1047CR	60Z19	60Z19	625G	1225G	62KA	VAT1
34A	1034A	49D	1049D	60Z2	60Z2	625K	1427	62KB	VCA1
34H	1034H	49E	1049E	60Z3	60Z3	625PL	1225PL	62KC	62RG
34N	1034N	4ARM	994ARM	60Z4	60Z4	62A	62A	62KD	62KD
355ST	355ST	4M	994M	60Z5	60Z5	62B	B62B	62KE	VAE1
36A	1036A	50A	50A	60Z6	60Z6	62BA	62BA	62KF	KFV1
36G	1036G	50AR	50AR	60Z7	60Z7	62BL	62BL	62KG	CA91D
36S	1036S	52A	1052A	60Z8	60Z8	62BZ	62BZ	62KT	62KT
36SF	1036SF	52B	1052B	60Z9	60Z9	62C	62C	62KZ	62KZ
36U	1036U	53 MASTER	53	60ZD	60ZD	62CA	CE1	62L	ET9
37 MASTER	37	54F	1054F	610B	610B	62CKK	62CKK	62LG	62LG
37D	37D	54FA	54FA	610BL	610BL	62CS	62CS	62M	62M

CROSS REFERENCE





DOMINION

62ME	S91A
62MK	S91K
62N	ZN2
62P	LP7
62PD	62PD
62PE	62PE
62PF	62PF
62PG	62PG
62PH	62PH
62PR	62PR
62PT	62PT
62Q	LP29R
62QA	LP27
62QB	LP28
62QD	LP26
62QN	62QN
62QS	62QS
62QT	62QT
62R	62R
62RE	RG1
62RS	62RS
62SA	INS1
62SH	62SH
62SN	VK9
62TA	62TA
62TC	62TC
62U	62U
62UC	62UC
62US	ST91A
62VA	62VA
62VB	62VB
62VC	62VC
62VE	62VE
62VG	62VG
62VH	62VH
62VJ	62VJ
62VK	V61VW
62VM	62VM
62VO	62VO
62VP	62VP
62WA	62WA
62WB	62WB
62X	62X
62XL	EX1
62Z	62Z
632M	632M
633M	1233M
633MH	633MH
63A	63A
63B	MB5
63C	63C
63D	1063D
63E	63E
63F	63F
63G	63G

63H	63H
63JA	63JA
63K	63K
63L	63L
63M	63M
63P	63P
63PX	63PX
63Q	63Q
63SG	F91GS
63SH	F91HS
63SP	63SP
63ST	63ST
63TS	63TS
63TV	63TV
63TW	63TW
63VM	VW63A
63VN	63VN
63VO	63VO
63VP	63VP
63VR	63VR
63VS	63VS
63W	63W
63WG	63WG
63Y	63Y
642L	1242L
643CL	O1028AH
64A	1064
64D	DO1M
64D	64D
64E	VW1CZ
64G	64G
64GS	DO3M
64K	64K
64L	1064L
64R	64R
64RD	64RD
64SS	64SS
64T	TS2
64X	64X
64Y	64Y
65CA	65CA
65CB	65CB
65CD	65CD
65CE	65CE
65CF	65CF
65F	SE91L
65G	GU4
65J	65J
65K	65K
65L	65L
65M	65M
65S	SOS91
65T	65T
65U	AR91
65Y	GU91F
663SG	1063E
66A	66A
66B	66BB
66E	66E

66M	66B
670C	1270C
67B	1067B
67C	67CL
67CT	RC1
67F	FL91
67G	67G
67H	67H
67J	67J
67LA	67LA
67LB	67LB
67LC	67LC
67LD	67LD
67N	67N
67P	67P
67Q	67Q
67S	CA91C
67T	67T
67U	67U
67W	67W
686B	1286B
686C	1286C
686E	1286E
687W	687W
687X	687X
687Y	687Y
68M	68M
69-5X	1069-5X
69-5Y	1069-5Y
69-5Z	1069-5Z
69B	1069B
69C	1069C
69E	1069E
69G	1069P
69M	1069MD
69T	1069T
6M	996M
701G	1701G
702K	1702K
703K	1703K
703S	703S
704K	704K
705K	1705K
706K	1706K
707A	1307A
707K	D1707K
707W	1307W
70R	DA3
719S	719S
71A	1071A
71AB	1071AB
71B	1071B
732S	1332S
73DF	1073DF
73DG	A1074B
73M	73M
74E	1074E
74F	1074F
74G	1074G

74N	1074N
755U	755U
759L	D1759L
761MP	1761MP
761MS	1761MS
764P	1764P
764S	1764S
765D	1028
765S	1766S
765T	1767DT
768CH	1768CH
769CH	1769CH
770CH	1770CH
770L	1370
770U	P1770U
771CH	X16
79AB	1079AB
79B	1079B
7A	997A
7B	997B
7CH	GAS91
7D	997D
7DA	997DA
7DB	997DB
7DC	7DC
7DE	V91E
7E	997E
7EB	997EB
7EH	YL1
7ER	997ER
7F	Y204
7G	997G
7GE	7GE
7GR	997GR
7GX	997GX
7GXR	997GXR
7JA	997JA
7JB	997JB
7JC	997JC
7JD	997JD
7JE	997JE
7JF	997JF
7JG	997JG
7JH	997JH
7JK	997JK
7K	YL5
7KV	KVR91
7L	997L
7LA	7LA
7LB	7LB
7LC	7LC
7LD	7LD
7LDH	7LDH
7LE	7LE
7LF	7LF
7LG	7LG
7LH	7LH
7M	7B
7RA	7RA

7RB	7RB
7RC	7RC
7RD	7RD
7RE	7RE
7RF	7RF
7RG	7RG
7RH	7RH
7X	997X
816A	816A
817A	1214
8418N	T80
841A	1133A
8446F	T40
8446R	T39
884BR	884BR
884BS	884BS
884R	884R
885BL	885BL
885R	885R
8A	998A
8FD	998FD
8GA	998GA
8GB	998GB
8GC	998GC
8GD	998GD
8GE	998GE
8GF	998GF
8GG	998GG
8GH	998GH
8GK	998GK
8GST	998GST
8LA	998LA
8LB	998LB
8LC	998LC
8LD	998LD
8LE	998LE
8LF	998LF
8LG	998LG
8LH	998LH
8LK	998LK
8PA	998PA
8R	998R
8S	998S
8SA	998SA
8SB	998SB
8SC	998SC
8SD	998SD
8SE	998SE
8SF	998SF
8SG	998SG
8SH	998SH
8SM	998SMK
8TA	998TA
8VA	998VA
8VB	998VB
8VC	998VC
8VD	998VD
8VE	998VE
8VG	998VG

CROSS REFERENCE





DOMINION	ILCO	DOMINION	ILCO	DOMINION	ILCO	DOMINION	ILCO	DOMINION	ILCO
8VH	998VH	9VE	999VE	A170D	A1170D	AK3	AK3		
8VK	998VK	9VG	999VG	A2	A2	AK4	AK4		
92B	1092B	9VH	999VH	A3	A3	AK5	AK5		
92C	1092C	9W	W91C	A41JA	C1041R	AK6	AK6		
92V	1092V	A01MA	A1001MA	A41JB	C1041JB	AL1	AL1-BLK	DOMINION	ILCO
92VM	1092VM	A01MB	A1001MB	A41JC	C1041T	AM1	BIL1	AS46	AS46
951R	T60	A01MF	A1001MF	A41U	A1041U	AP1	ALP1	AS47	AS47
96C	1096C	A01MJ	A1001MJ	A41X	1046A	AP10	ALP10	AS48	AS48
96L	1096L	A1	A1	A54B	A54B	AP2	ALP2	AS49	AS49
970AM	1970AM	A10N	L1010N	A54F	A54F	AP3	ALP3	AS5	AS5
98DB	1098DB	A114A	A1114A	A61Q	A61Q	AP4	ALP4	AS50	AS50
98JD	1098JD	A114B	A1114B	A61T	A61T	AP5	ALP5	AS51	AS51
98L	1098L	A114C	A1114C	A61W	A61W	AP6	ALP6	AS52	AS52
98M	1098M	A114D	A1114D	A62A	A62A	AP7	ALP7	AS53	AS53
98X	1098X	A114DD	A1114DD	A62L	A62L	AP8	ALP8	AS54	AS54
98XL	1098XL	A114E	A1114E	A62QN	A62QN	AP9	ALP9	AS55	AS55
9A	999A	A114F	A1114F	A62VC	A62VC	AR1	MAS1	AS56	AS56
9BA	9BA	A114G	A1114G	A62VN	A62VN	AR61Q	AR61Q	AS57	AS57
9C	Y201	A114GM	A1114M	A63L	A63L	AR61T	AR61T	AS58	AS58
9CA	999CA	A114H	A1114H	A74E	A1074E	AR61W	AR61W	AS59	AS59
9CR	Y202	A114J	A1114J	A74F	A1074F	AR62K	AR62K	AS6	AS6
9CS	9CS	A114K	A1114K	A74G	A1074G	AS1	AS1	AS60	AS60
9CX	9CX	A114L	A1114L	A7EH	A997EH	AS10	AS10	AS61	AS61
9D	ID1	A114M	A1114FM	A8GST	A998GST	AS11	AS11	AS62	AS62
9D	9D	A11D1	A1011D1	AA1	ATA1	AS12	AS11	AS63	AS63
9ET	LT1	A11D2	A1011D2	AA2	ATA2	AS13	AS13	AS64	AS64
9FAC	9FAC	A11D3	A1011D3	AB1	AB1	AS14	AS14	AS65	AS65
9GA	999GA	A11D4	A1011D4	AB10	AB10	AS15	AS15	AS66	AS66
9GB	999GB	A11P	A1011P	AB11	AB11	AS16	AS16	AS67	AS67
9GC	999GC	A11S	A1011S	AB12	AB12	AS17	AS17	AS68	AS68
9GD	999GD	A11T	A1011T	AB13	AB13	AS18	AS18	AS69	AS69
9GE	999GE	A145	1145A	AB14	AB14	AS19	AS19	AS7	AS7
9GF	999GF	A145CE	A1145CE	AB15	AB15	AS2	AS2	AS70	AS70
9GG	999GG	A145E	A1145E	AB16	AB16	AS20	AS20	AS71	AS71
9GH	999GH	A145EF	A1145EF	AB17	AB17	AS21	AS21	AS72	AS72
9GK	999GK	A145F	A1145F	AB18	AB18	AS22	AS22	AS73	AS73
9K	GU91B	A145FG	A1145FG	AB19	AB19	AS23	AS23	AS74	AS74
9LA	999LA	A145G	A1145G	AB20	AB20	AS24	AS24	AS75	AS75
9LB	999LB	A145H	A1145H	AB21	AB21	AS25	AS25	AS76	AS76
9LC	999LC	A145J	A1145J	AB22	AB22	AS27	AS27	AS77	AS77
9LD	999LD	A145K	A1145K	AB3	AB3	AS28	AS28	AS78	AS78
9LE	999LE	A145L	A1145L	AB4	AB4	AS29	AS29	AS79	AS79
9LF	999LF	A14DR	A1014DR	AB5	AB5	AS3	AS3	AS8	AS8
9LG	999LG	A15C	A1015C	AB6	AB6	AS30	AS30	AS80	AS80
9LH	999LH	A15L	A1015L	AB7	AB7	AS31	AS31	AS81	AS81
9LK	999LK	A15M	A1015M	AB8	AB8	AS32	AS32	AS82	AS82
9MX	9MX	A15N	A1015N	AB9	AB9	AS33	AS33	AS86	AS86
9P	PR91N	A15P	A1015P	AC1	1131	AS34	AS34	AS89	AS89
9PS	PR91SA	A15Q	A1015Q	AC2	1131R	AS35	AS35	AS9	AS9
9PT	PR91C	A15R	A1015R	AD1	AD1	AS36	AS36	AS90	AS90
9R	999R	A15S	A1015S	AE1	AE1	AS37	AS37	AU1	AU1
9RY	ER5	A15T	A1015T	AG1	AG1	AS38	AS38	AU2	AU2
9T	999T	A15U	A1015U	AG2	AG2	AS39	AS39	AU3	AU3
9TK	9TK	A15V	A1015V	AG3	AG3	AS4	AS4	AU4	AU4
9U	999U	A15W	A1015W	AG4	AG4	AS40	AS40	AU5	AG1R
9VA	999VA	A15X	A1015X	AG5	AG5	AS41	AS41	AU5	AU5
9VB	999VB	A15Y	A1015Y	AK1	AK1	AS43	AS43	AU6	AU6
9VC	999VC	A170B	A1170CB	AK2	AK2	AS44	AS44	B17	B17
9VD	999VD	A170C	A1170C	AK22W	AK22W	AS45	AS45	B20	B20

CROSS REFERENCE

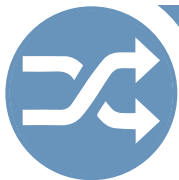

	DOMINION	ILCO	DOMINION	ILCO	DOMINION	ILCO	DOMINION	ILCO
	BG1	K1122C	BU1	BU1	CE9-2X	FC9	CS43	CS43
	BG2	L1054M	BU2	BU2	CE9-3X	FC8	CS44	CS44
	BG3	K1054B	BU3	BU3	CE9-RH	FC7-P	CS45	CS45
	BG4	K1122B	BU4	BU4	CF1	CF1	CS46	CS46
	BG5	L1098M	BU7	BU7	CF2	CF2	CS47	CS47
	BG6	K1122D	BU8	BU8	CH1	1147	CS48	CS48
	BG7	K1122N	BV1	BV1	CH3	CH3	CS49	CS49
	BH1	BH1	BV2	BV2	CH4	CH4	CS50	CS50
	BH2	BH2	BW1	1511	CH5	CH5	CS51	CS51
	BK1	BK1	BW2	1510	CH6	CH6	CS52	CS52
	BK10	BK10	BY1	BY1	CH7	CH7	CS53	CS53
	BK11	BKS11	C1S	C1S	CH8	CH8	CS54	CS54
	BK12	BKS12	C2S	C2S	CL1	CL3	CS55	CS55
	BK13	BKS13	C30M	C30M	CL2	CL2	CS56	CS56
	BK14	BKS14	C350	C350	CM1	L1096CN	CS57	CS57
	BK15	BKS15	C3S	C3S	CM2	C1096C	CS58	CS58
	BK16	BKS16	C41C	C1041C	CM3	1096FL	CS59	CS59
	BK17	BKS17	C4S	C4S	CM4	1096FM	CT1	CT1
	BK18	BKS18	C53	C53	CM5	1096FS	CT2	CT2
	BK19	BKS19	C5S	C5S	CN1	CN1	CU1	1040
	BK2	BKS2	C61Y	WA91PR	CN2	CN2	CU10	CU10
	BK20	BKS20	C67K	C67K	CN3	CN3	CU11	1040U
	BK21	BKS21	C6S	C6S	CN4	CN4	CU12	CU12
	BK22	BKS22	C9	C999	CN5	CN5	CU2	1040A
	BK23	BKS23	C92	C92	CO1	CTG1	CU3	R1040C
	BK24	BKS24	C92B	C92B	CO2	CTG2	CU4	1040C
	BK25	BKS25	C98A	C1098A	CS10	CS10	CU5	1040E
	BK26	BKS26	CA1	X9	CS11	CS11	CU6	R1040E
	BK27	BKS27	CA1-RH	73VB-P	CS12	CS12	CU7	CU7
	BK28	BKS28	CA2	CA2	CS13C	CS13	CU8	CU8
	BK29	BKS29	CA3	CA3	CS14	CS14	CU9	CU9
	BK3	BKS3	CA4	CA4	CS15	CS15	CW1	CW1
	BK30	BKS30	CA5	X110	CS16	CS16	CY1	CA91L
	BK31	BKS31	CB1	CB1	CS17	CS17	D1A	D1A
	BK32	BKS32	CB10	CB10	CS18	CS18	D1K	D1K
	BK33	BKS33	CB11	CB11	CS19	CS19	D1T	D1T
	BK34	BKS34	CB2	CB2	CS20	CS20	D1V	D1V
	BK35	BKS35	CB3	CB3	CS21	CS21	D61Y	WA91S
	BK36	BKS36	CB6	CB12	CS22	CS22	D62SA	D62SA
	BK4	BKS4	CB7	CB7	CS23	CS23	D64	D64
	BK5	BKS5	CB9	CB9	CS24	CS24	D67K	D67K
	BK6	BKS6	CC1	C1041SR	CS25	CS25	D8	H998
	BK7	BKS7	CC2	C1041TR	CS26	CS26	D8GA	D998GA
	BK8	BKS8	CC21	CC21	CS27	CS27	D8GB	D998GB
	BK9	BKS9	CC29	CC29	CS28	CS28	D8GC	D998GC
	BL1	BL91	CC3	SC1041TR	CS29	CS29	D8GD	D998GD
	BL2	BL2	CC30	CC30	CS30	CS30	D8GE	D998GE
	BM1	BM1	CC4	SC1041SR	CS31	CS31	D8GF	D998GF
	BM2	BM2	CC5	C1041YR	CS32	CS32	D8GG	D998GG
	BO1	BO6	CD1	CD1	CS33	CS33	D8GH	D998GH
	BO2	BO2	CE1	BR20	CS34	CS34	D8GK	D998GK
	BR1	BR1	CE2	CE2	CS35	CS35	D9	D9
	BR62QB	LP39	CE3	CE3	CS36	CS36	D98BM	D1098BM
	BR9CS	CS91C	CE4	CE4	CS37	CS37	D98E	D1098B
	BS1	BS1	CE5	CE5	CS38	CS38	D98X	D1098X
	BT1	BT1	CE6	CE6	CS39	CS39	D9CS	AB62FR
	BT2	BT2	CE7	CE7	CS40	CS40	DB1	DB1
	BT3	BT3	CE8	CE8	CS41	CS41	DB2	DB2
	BT4	BT4	CE9	X86	CS42	CS42	DD1	DD1



DOMINION	ILCO	DOMINION	ILCO	DOMINION	ILCO	DOMINION	ILCO	DOMINION	ILCO
DH1	DH1	DM64	DM64	E8GA	H998GA	FL4	FL4		
DH2	DH2	DM7	DM7	E8GB	H998GB	FL5	FL5		
DL2	DL2	DM8	DM8	E8GC	H998GC	FL54WA	L1054WC		
DM1	FT6	DM9	FT6R	E8GD	H998GD	FL5G	FL5G	DOMINION	ILCO
DM10	DM10	DN1	DN1	E8GE	H998GE	FL5H	A1054WD	H122AR	H122AR
DM11	DM11	DO1	DO1	E8GF	H998GF	FR00V	FR1000V	H122F	H1122F
DM12	DM12	DO2	DO2	E8GG	H998GG	FR1	FLR1	H122FR	H1122FR
DM13	DM13	DO3	DO3	E8GH	H998GH	FR2	FLR2	H122M	H1122M
DM14	DM14	DO4	DO4	E8GK	H998GK	FR65	FR65	H122W	H1122W
DM15	DM15	DO5	DO5	E96LN	C1096LN	FR65A	FR65A	H132	H1132
DM16	DM16	DO6	DO6	EB96K	EB1096K	FR65S	FR65S	H175	1175N
DM17	DM17	DP1	DP1	EF2	EF2	FS1	FS1	H176	1176
DM18	DM18	DR61F	DR61F	EF3	EF3	FT1	FT1	H199A	H199A
DM19	DM19	DR9CS	AB62F	EG1	C1096CN	FT3	FTH3	H199N	H199N
DM2	DM2	DT1	DT1	EG2	S1096JN	FT4	FTH4	H22W	N1179
DM20	DM20	DT10	DT10	EG3	1154C	FT5	FTH5	H41X	A1045
DM21	DM21	DT11	DT11	ER1	ERS1	FT6	FTH6	H54B	H1054B
DM22	DM22	DT12	DT12	ER2	ERS2	FV1	FV1	H54F	H1054F
DM23	DM23	DT13	DT13	ER3	ERS3	GA1	1098GX	H54KD	D1054K
DM24	DM24	DT14	DT14	ER4	ER10	GB1	GB1	H54WA	1054WB
DM25	DM25	DT15	DT15	ER5	ERS5	GB2	GB2	H61G	H61G
DM26	DM26	DT16	DT16	ER6	ERS6	GB3	GB3	H61N	H61N
DM27	DM27	DT17	X10	ER7	ER9	GB4	GB4	H61NA	H61NA
DM28	DM28	DT18	DT16	ER8	ERS8	GC1	GC1	H61P	H61P
DM29	DM29	DT19	X7	ES1	ES1	GE1	GE1	H61SA	H61SA
DM3	DM3	DT2	DT2	ES1R	ES1R	GE10	GE10	H61SB	H61SB
DM30	DM30	DT20	DT20	ET1	ET1	GE11	GE11	H61V	H61V
DM31	DM31	DT21	DA23	EV3	EVA1R	GE14	GE14	H61VM	H61VM
DM32	DM32	DT22	X114	EV4	EV4	GE15	GE15	H61VO	H61VO
DM33	DM33	DT22W	DT22W	EV5	EV5	GE2	GE2	H61VR	H61VR
DM34	DM34	DT23	X123	EV6	EV6	GE3	GE3	H62BM	H62BM
DM35	DM35	DT24	X124	EV7	EV7	GE4	GE4	H62BZ	H62BZ
DM36	DM36	DT3	DT3	EZ1	ELZ1	GE5	GE5	H62CM	H62CM
DM37	DM37	DT4	DT4	F00V	F1000VR	GE6	GE6	H62DG	H62DG
DM38	DM38	DT5	DT5	F1	1190LN	GE7	GE7	H62DM	H62DM
DM39	DM39	DT6	DT6	F122A	F1122A	GE9	GE9	H62DP	H62DP
DM4	DM4	DT7	DT7	F122AR	F1122AR	GH1	GH1	H62DR	H62DR
DM40	DM40	DT8	DT8	F2	1185FD	GH2	GH2	H62FD	H62FD
DM41	DM41	DT9	DT9	F3	1184FD	GH3	GH3	H62KB	H62KB
DM42	DM42	DTL22W	DTL22W	F54WA	1054WC	GL1	GL1	H62PD	H62PD
DM43	DM43	DW1	DW1	F65	F65	GL2	GL2	H62QN	LP30
DM44	DM44	DW2	DW2	F65A	F65A	GL3	GL3	H62QS	LP31
DM45	DM45	DXB1	DXB1	F65L	F65L	GL4	GL4	H62QT	LP32
DM46	DM46	DXB2	DXB2	FA1	X99	GL5	GL5	H62VB	62VW
DM47	DM47	DXB3	DXB3	FA54WA	A1054WC	GN1	GN1	H62VG	H62VG
DM48	DM48	DXBM	DXB4	FB1	FB1	GO1	GO1	H62VK	H62VK
DM49	DM49	DXC1	DXC1	FB2	FB2	GR1	GRD1	H62VN	61VW
DM5	DM5	DXC2	DXC2	FB3	FB3	GT1	GT1	H62VP	H62VP
DM50	DM50	DXC3	DXC3	FB4	FB4	GT2	GT2	H63G	H63G
DM51	DM51	DXCM	DXC4	FB5	FB5	GT3	GT3	H63M	H63M
DM52	DM52	DXD1	DXD1	FB6	FB6	GT4	GT4	H63N	MB59
DM57	DM57	DXD2	DXD2	FB7	FB7	GT5	GT5	H63VO	H63VO
DM58	DM58	DXD3	DXD3	FE1	FE1	GV1	GAV1	H64	H64
DM59	DM59	DXDM	DXD4	FF1	FF1	GV2	GAV2	H64E	H64E
DM6	DM6	DXGM	DXG5	FH1	FCT45	GW1	GW1	H64K	H64K
DM60	DM60	E122A	E1122A	FH4	FH4	H10F	H10F	H64S	H64S
DM61	DM61	E374	E374	FL1	FL1	H122A	H122A	H67K	H67K
DM62	DM62	E375	E375	FL2	FL2	H122AL	H122AL	H69	1069N
DM63	DM63	E67K	E67K	FL3	FL3	H122ALR	H122ALR	H7E	H997E

CROSS REFERENCE

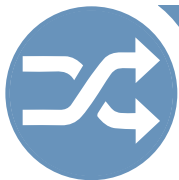

DOMINION ILCO

H7EB H997EB
H7ER H997ER
H7LA H7LA
H7LB H7LB
H7LC H7LC
H7LD H7LD
H7LDH H7LDH
H7LE H7LE
H7LF H7LF
H7LG H7LG
H7LH H7LH
H7RA H7RA
H7RB H7RB
H7RC H7RC
H7RD H7RD
H7RDH H7RDH
H7RE H7RE
H7RF H7RF
H7RG H7RG
H7RH H7RH
H9 H999
H98A H1098A
H98C H1098C
H98DB H1098DB
H98L H1098L
H98LA H1098LA
H98M H1098M
H98X H1098X
H98XL H1098NR
H9R H999R
HD1 HD1
HD10 HD10
HD11 HD11
HD12 HD12
HD13 HD13
HD14 HD14
HD15 HD15
HD16 HD16
HD17 HD17
HD18 HD18
HD19 HD19
HD2 HD2
HD20 HD20
HD21 HD21
HD22 HD22
HD23 HD23
HD24 HD24
HD25 HD25
HD26 HD26
HD28 HD28
HD29 HD29
HD3 HD3
HD30 HD30
HD31 HD31
HD32 HD32

Table with 9 columns: DOMINION, ILCO, DOMINION, ILCO, DOMINION, ILCO, DOMINION, ILCO. Contains cross-reference data for various codes like HD33, HD34, HD35, etc.





DOMINION	ILCO	DOMINION	ILCO	DOMINION	ILCO	DOMINION	ILCO	DOMINION	ILCO
L54KD	A1054KD	LC2	LC2	LS19	LS19	MZ15R	MZ13R		
L54WA	L54WA	LC3	LC3	LS22	LS22	MZ2	X3		
L5CR	L5CR	LC4	LC4	LS23	LS23	MZ3	X2		
L5RC	L5RC	LC5	LC5	LS28	LS28	MZ4	X4	DOMINION	ILCO
L61D	L61D	LC6	S1096G	LS29	LS29	MZ5	X5	NE42	NE42
L61G	L61G	LC8	LC8	LS32	LS32	MZ6	MZ6	NE43	NE43
L61JD	VA91	LE1	LE1	LS33	LS33	MZ7	MZ7	NE44	NE44
L61K	L61K	LF1	LF1	LS34	LS34	MZ8	MZ8	NE45	NE45
L61Y	WA91WL	LF10	LF10	LS35	LS35	MZ9	X26	NE46	NE46
L62CS	L62CS	LF11	LF11	LS50	LS50	N54B	N54B	NE47	NE47
L62DM	L62DM	LF12	X50	LS51	LS51	N54G	N54G	NE48	X170
L62FD	L62FD	LF13	LF13	LSR	LSR1	N63G	N63G	NE49	NE49
L62K	ZE91CR	LF14	LF14	LT1	LT3	N64D	1064D	NE5	NE5
L62KE	L62KE	LF15	LF15	LU1	LU1	N686	N1286	NE50	X140
L62QT	L62QT	LF16	LF16	LU2	LU2	N686R	N1286R	NE54	NE54
L62TC	L62TC	LF17	X157	M127	1127DU	N704K	1704K	NE55	NE55
L62UC	L62UC	LF18	LF18	M127A	M1127A	N98XL	1098NR	NE56	NE56
L62US	L62US	LF19	LF19	M63B	M63B	NC1	NC1	NE57	NE57
L62VA	L62VA	LF2	LF2	M63E	M63E	NC2	NC2	NE58	NE58
L62VB	L62VB	LF21	LF21	M64	M64	NC3	NC3	NE59	NE59
L62VJ	L62VJ	LF23	LF23	M65F	M65F	NC91F	1083P	NE6	VO6
L62VN	L62VN	LF24	LF24	M69C	M1069C	NC91T	1083S	NE62	X139
L63G	L63G	LF3	LF3	M69G	1069M	NC96D	1083H	NE62-RH	V35-P
L64B	1069LB	LF4	X13	MA1	1092N	NC96K	NC96K	NE7	NE7
L64C	L1064C	LF5	LF5	MA2	1092H	NC96M	NC96M	NE8	NE8
L65F	SEL91	LF6	LF6	MA4	1092D	NC96T	1083	NE9	NE9
L65G	L65G	LF7	LF7	MA5	1092DS	NE1	NE1	NF1	NF1
L65Y	L65Y	LF8	LF8	MA6	1092J	NE10	NE10	NF2	NL2
L67A	L67A	LF9	LF9	MA7	MA7	NE11	NE11	NL1	NL1
L67B	L67B	LM1	LM1	MB1	MB1	NE12	VO62	NR63G	NR63G
L68	1068E	LM2	RT19	ME1	ME1	NE13	NE13	NR64D	R1064E
L69FD	1069YM	LN1	LN1	ME2	ME2	NE14	NE14	NS9CS	NS9CS
L6FM	L6FM	LN3	LN3	ME3	ME3	NE15	NE15	NSR9CS	NSR9CS
L6S	L6S	LP1	LAP1	ME4	ME4	NE16	NE16	NU07CA	O1007CA
L707A	L1307A	LP2	LAP2	ME5	ME5	NE17	NE17	NU07CB	O1007CB
L707W	L1307W	LR1	LR1	ME6	ME6	NE18	NE18	NU07CC	O1007CC
L98C	L1098C	LR191A	VR91R	ME7	ME7	NE19	NE19	NU07CD	O1007CD
LA1	LA1	LR61D	LR61D	MG1	AL3	NE2	NE2	NU07CDH	O1007CDH
LA10	LA10	LR61G	LR61G	MM2	MM2	NE20	NE20	NU07CDM	O1007CDM
LA11	LA11	LR61JD	LR61JD	MN1	MN1	NE21	X51	NU07CE	O1007CE
LA12	LA12	LR61K	WL2	MO1	MO1	NE22	NE22	NU07CF	O1007CF
LA13	LA13	LR61Y	WA91L	MR1	MR1	NE23	NE23	NU07CG	O1007CG
LA14	LA14	LR62DG	LR62DG	MR2	MR2	NE24	X29	NU07CH	O1007CH
LA2	LA2	LR62K	ZE91C	MR3	MR3	NE25	X30	NU07CHM	O1007CHM
LA3	LA3	LR62QT	LR62QT	MR63E	MR63E	NE26	NE26	NU07CJ	O1007CJ
LA4	LA4	LR62US	LR62US	MS12	X54	NE27	NE27	NU07CK	O1007CK
LA5	LA5	LR62VA	LR62VA	MS13	MS13	NE29	NE29	NU07CL	O1007CL
LA6	LA6	LR62VB	LR62VB	MS15	X121	NE30	NE30	NU07CM	O1007CM
LA7	LA7	LR62VJ	LR62VJ	MS2	MS2	NE31	NE31	NU07CN	O1007CN
LA8	LA8	LR63G	LR63G	MT1	1181C	NE32	X12	O1S	O1S
LA9	LA9	LR65F	SEL91R	MW1	MW1	NE33	NE33	OL1	1171
LB1	LB1	LR65G	LR65G	MW2	MW2	NE34	NE34	OL2	1171B
LB2	LB2	LR65Y	LR65Y	MZ1	MZ1	NE35	X80	OM1	OM10
LB3	LB3	LR7GE	LR7GE	MZ10	X27	NE36	X85	P54F	P54F
LB4	LB4	LS10	LS10	MZ11	X36	NE37	X92	P64H	P64H
LB5	LB5	LS11	LS11	MZ12	X1	NE39	NE39	P64K	P64K
LB6	LB6	LS16	LS16	MZ13	MZ15	NE4	NE4	P65A	P65A
LB7	LB7	LS17	LS17	MZ14	X60	NE40	X61	P65C	P65C
LC1	LC1	LS18	LS18	MZ15	X131	NE41	NE41	P98A	P1098A

CROSS REFERENCE

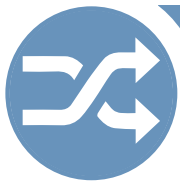

CROSS REFERENCE

	DOMINION	ILCO	DOMINION	ILCO	DOMINION	ILCO	DOMINION	ILCO	
		R61JD	R61JD	R63Y	R63Y	RUN18	A1011-18N	S67B	S67B
		R61K	R61K	R64D	R1064D	RUN19	A1011-19N	S67K	S67K
		R61N	R61N	R64T	R64T	RUN20	A1011-20N	S69	70S
		R61NA	R61NA	R65F	R65F	RUN21	A1011-21N	S69T	S1069T
DOMINION	ILCO	R61P	R61P	R65G	GU4R	RUN22	A1011-22N	S73DE	1074BM
P98C	P1098C	R61Q	R61Q	R65S	R65S	RUN23	A1011-23N	S73DF	S1073DF
P98E	P1098E	R61ST	R61ST	R65U	R65U	RUN24	A1011-24N	S73DG	1074B
P98J	P1098J	R61T	R61T	R65Y	GU91G	RUN25	A1011-25N	S770CH	U1770CH
PE1	PE1	R61TS	R61TS	R66E	R66E	RUN26	A1011-26N	S770U	S1770U
PJ1	PJ1	R61W	R61W	R67F	R67F	RUN27	A1011-27N	S7CH	GA1
PJ11	PJ11	R61Y	WA91	R67K	R67K	RUN28	A1011-28N	S7JA	S7JA
PJ12	PJ12	R61Z	ZKN2	R67N	R67N	S00KT	S1000XK	S970AM	S1970AM
PJ13	PJ13	R62B	R62B	R67P	R67P	S00T	S1000T	S98B	S1098B
PJ14	PJ14	R62BA	R62BA	R67Q	R67Q	S00V	S1000V	S98D	S1098D
PJ2	PJ2	R62BZ	R62BZ	R67T	R67T	S00X	S1000X	S98H	S1098H
PJ3	PJ3	R62CA	R62CA	R67U	RK3	S01JB	S1001JB	S98K	S1098K
PJ4	PJ4	R62DG	R62DG	R67W	RU91C	S127FD	S1127FD	S9CS	S9CS
PK1	PKR1	R62DH	R62DH	R686B	1286BR	S127FL	S1127FL	S9P	S9P
PL1	PL1	R62DM	R62DM	R686E	R1286E	S127FR	S1127FR	SA1	STA1
PN1	PN1	R62EV	R62EV	R707A	R1307A	S127LC	S1127LC	SB1	SB1
PN2	PN2	R62GE	GE3R	R707W	R1307W	S127ME	S1127ME	SB10	SB10
PN3	PN3	R62K	R62K	R7DA	R997DA	S127MU	S1127MU	SB2	SB2
PO1	PO1	R62KB	VCA1R	R7DC	R7DC	S137	1136S	SB3	SB3
PO2	PL2	R62ME	S91BV	R7EB	R997EB	S167FD	S1167FD	SB4	SB4
PR1	PR1	R62P	LP7R	R9CS	R9CS	S191A	VR91S	SB5	SB5
PU1	PU1	R62PD	R62PD	R9ET	LT2	S33C	S33C	SB6	SB6
PU2	PU2	R62PE	R62PE	R9K	GU3	S33N	UN5	SB7	SB7
PU3	PU3	R62PF	R62PF	R9LF	R9LF	S33P	S33P	SB8	X31
PU4	PU4	R62PG	R62PG	R9LK	R9LK	S41E	S1041T	SB9	X52
PU5	PU5	R62Q	LP29	R9P	PR91A	S42M	S1042ZM	SC51	SC51
PZ1	PZ1	R62QA	LP6	R9PS	PR91NS	S42Z	S1042Z	SC52	SC52
PZ2	PZ2	R62QB	R62QB	RA01MJ	A1001MJR	S54G	S54G	SD1	1148
PZ3	PZ3	R62TA	R62TA	RI5	RI5	S5M	5B	SE1	SIM1
PZ4	PZ4	R62TS	R62TS	RI6	RI6	S60	S60	SE10	SIM10
R00T	R1000T	R62UC	R62UC	RK1	RK1	S60R	S60R	SE2	SIM2
R00V	R1000V	R62US	R62US	RL1	RL1	S61	Z91K	SE3	SIM3
R01D	R1001D	R62VA	R62VA	RL2	RL2	S61JD	S61JD	SE6	SIM6
R01ED	R1001ED	R62VB	R62VB	RL3	RL3	S61R	Z91KR	SE8	SIM8
R01EE	R1001EE	R62VK	U61VW	RN1	RN1	S61W	V61A	SE9R	SIM9R
R01EF	R1001EF	R62VN	R62VN	RS1	1140G	S625P	S625P	SF1	F91C2
R01EG	R1001EG	R62WA	R62WA	RS65G	RS65G	S62DP	S62DP	SF10	SF10
R01EL	R1001EL	R62X	R62X	RU22A	1022H	S62DR	S62DR	SF11	SF11
R01EN	R1001EN	R62Z	R62Z	RUK1	A1011-1N	S62DV	BS62DV	SF2	F91C
R01ES	R1001ES	R63E	R63E	RUK10	A1011-10N	S62DW	S62DW	SF3	F91CR
R01MJ	R1001MJ	R63G	R63G	RUK11	A1011-11N	S62FD	S62FD	SF4	F91C8
R132	R1132	R63H	R63H	RUK12	A1011-12N	S62K	GA91	SF5	FT37
R191	VR91A	R63K	R63K	RUK13	A1011-13N	S62KB	S62KB	SF6	FT38
R191B	VR91BR	R63KE	R63KE	RUK2	A1011-2N	S62QA	LP1R	SF7	SF7AF
R191C	VR91C	R63PX	R63PX	RUK3	A1011-3N	S62QD	LPD2	SF8	SF8
R22L	R1022L	R63Q	RE61XR	RUK4	A1011-4N	S62US	S62US	SF9	SF9
R41DC	R1041DC	R63SP	R63SP	RUK5	A1011-5N	S62VP	S62VP	SG1	1063
R41DV	R1041DV	R63ST	R63ST	RUK6	A1011-6N	S62VT	S62VT	SG2	SG2
R41Y	SC1041YR	R63TK	R63TK	RUK7	A1011-7N	S63B	S63B	SG3	1063B
R60HR	R60HR	R63TS	R63TS	RUK8	A1011-8N	S64A	S1064A	SG4	SG4
R60ZD	R60ZD	R63TY	R63TY	RUK9	A1011-9N	S64D	DO1S	SG5	SG5
R61D	R61D	R63VM	FT3	RUKM	A1011PZ	S65	SES91	SH1	SCH1
R61E	R61E	R63VS	R63VS	RUN15	A1011-15N	S65CA	S65CA	SJ1	SJ1
R61G	R61G	R63W	R63W	RUN16	A1011-16N	S65F	S65F	SJ2	SJ2
R61GA	R61GA	R63WG	R63WG	RUN17	A1011-17N	S65G	S65G	SJ3	SJ3
R61H	R61H								



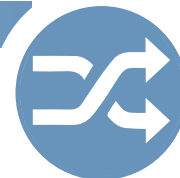

DOMINION	ILCO	DOMINION	ILCO	DOMINION	ILCO	DOMINION	ILCO	DOMINION	ILCO
SJ4	SJ4	SW1	SW1	TA25	TA25	TN3	TN3		
SJ5	SJ5	SW2	SW2	TA26	TA26	TN4	TN4		
SJ6	SJ6	SW3	SW3	TA27	X46	TN5	TN5		
SK1	SUZ1	SW4	SW4	TA28	TA28	TO1	TO1	DOMINION	ILCO
SK10	SUZ10	SW5	SW5	TA29	X137	TO2	TO2	U07RDH	O1007RDH
SK11	X87	SW6	SW6	TA3	T61B	TO3	TO3	U07RDM	O1007RDM
SK2	SUZ2	SW7	SW7	TA4	TA4	TO4	TO4	U07RE	O1007RE
SK3	SUZ3	SX1	SX1	TA5	TA5	TO5	TO5	U07RF	O1007RF
SK4	SUZ4	SX2	SU9L	TA6	TA6	TO6	TO6	U07RG	O1007RG
SK5	X11	SX3	SX3	TA7	TA7	TO7	TO7	U07RH	O1007RH
SK6	SUZ6	SX4	SX4	TA8	TA8	TR1	TR1	U07RHM	O1007RHM
SK7	SUZ7	SX9B	SX9B	TA9	TA9	TS1	TS1	U07RJ	O1007RJ
SK8	SUZ8	SY1	SY1	TB1	TB1	TT1	TT1	U07RK	O1007RK
SK9	SUZ9	SY10	SY10	TB2	TB2	TY1	TY1	U07RL	O1007RL
SL10	SLA10	SY11	SY11	TE1	TE1	TY2	1141F	U07RM	O1007RM
SL11	SLA11	SY12	SY12	TE2	TE2	TY3	1141K	U07RN	N1007RMA
SL12	SLA12	SY2	SY2	TE3	TE3	U00F	XO1000F	U09	O1009
SL13	SLA13	SY3	SY3-NS	TE4	TE4	U00FR	XO1000FR	U10	O1010
SL14	SLA14	SY4	SY4	TG1	TG1	U00GR	O1000GR	U10A	O1010A
SL15	SLA15	SY5	SY5-NS	TK1	TK1	U00GX	O1000GX	U122	O1122
SL16	SLA16	SY6	SY6-NS	TK10	TK10	U00H	O1000H	U122A	O1122A
SL17	SLA17	SY7	SY7	TK11	TK11	U00Z	A1001EH	U122AR	O1122AR
SM1	SM1	SY8	SY8-NS	TK12	TK12	U01A1	A1001AH	U122B	O1122B
SM2	SM2	SY9	SY9	TK13	TK13	U01A2	A1001FH	U122BE	O1122BE
SN1	1010B	SZ1	SZ1	TK14	TK14	U01AM	A1001AM	U122BER	O1122BER
SN2	S1010B	SZ2	SZ2	TK15	TK15	U01B1	A1001BH	U122BR	O1122BR
SP1	SP1	SZ4	SZ4	TK16	TK16	U01B2	A1001DH	U122C	O1122C
SP2	SP2	SZ5	SZ5	TK17	TK17	U01BM	A1001BM	U122R	O1122R
SP3	SP3	T167FD	1181FD	TK18	TK18	U01C1	A1001C1	U14JM	O1014JM
SP4	SP4	T35	T95	TK19	TK19	U01C2	A1001C2	U14JS	O1014J
SP5	SP5	T36	T96	TK2	TK2	U01CM	A1001CM	U14T	X1014F
SP6	X64	T37	T97	TK20	TK20	U01D1	A1001D1	U22	O1022
SP7	X79	T41Y	T41Y	TK21	TK21	U01D2	A1001D2	U22A	O1022AB
SP8	X78	T44	T44	TK22	TK22	U01DM	A1001DM	U611B	U611B
SP9	SP9	T54F	T54F	TK23	TK23	U01E	O1001E	U615	O1215
SQ3	SQ3	T61VR	T61VR	TK24	TK24	U01GM	A1001ABM	U621A	U621A
SR1	SR1	T67A	T67A	TK25	TK25	U01GRM	A1001GRM	U621L	O1221L
SR191A	SR191A	T67B	T67B	TK26	TK26	U01RM	A1001CDM	U623	O1223
SR2	SR2	T67C	T67C	TK27	TK27	U07JA	O1007JA	U623L	O1223L
SR3	SR3	T67D	T67D	TK28	TK28	U07LA	O1007LA	U62VA	U62VA
SR33N	BR13	T67E	T67E	TK29	TK29	U07LB	O1007LB	U62VB	U62VB
SR4	SR4	T67F	T67F	TK30	TK30	U07LC	O1007LC	U62VN	U62VN
SR5	SR5	TA1	TA1	TK31	TK31	U07LD	O1007LD	U62VP	U62VP
SR61N	SR61N	TA10	TR18	TK32	TK32	U07LDH	O1007LDH	U63H	U63H
SR61W	SR61W	TA11	TA11	TK33	TK33	U07LDM	O1007LDM	U65F	U65F
SR62QA	LP1	TA12	TA12	TK34	TK34	U07LE	O1007LE	U65S	SO91P
SR65	SR65	TA13	T61F	TK35	TK35	U07LF	O1007LF	U67K	U67K
SR67K	SR67K	TA14	TA14	TK36	TK36	U07LG	O1007LG	U759L	1759P
SR9CS	CS91B	TA15	TA15	TK37	TK37	U07LH	O1007LH	U7A	O997A
SR9P	SR9P	TA16	TA16	TK38	TK38	U07LHM	O1007LHM	U7E	O997E
SS1	SS1	TA17	T61C	TK39	TK39	U07LJ	O1007LJ	U7ER	O997ER
SS2	SS2	TA18	T61D	TK4	TK4	U07LK	O1007LK	U7G	O997G
SS3	SS3	TA19	TA19	TK41	TK41	U07LL	O1007LL	U7K	O997K
ST1	ST1	TA2	TA2	TK5	TK5	U07LM	O1007LM	U98B	O1098B
ST2	FAS1	TA20	TR26	TK6	TK6	U07LN	N1007KMA	U98D	O1098D
SV1	ST91F	TA21	X45	TK7	TK7	U07RA	O1007RA	U98LA	O1098LA
SV2	ST91V	TA22	X37	TK8	TK8	U07RB	O1007RB	U9CR	O999CR
SV3	SV3	TA23	TA23	TN1	TN1	U07RC	O1007RC	U9CS	CS91E
SV4	SV4	TA24	TA24	TN2	TN2	U07RD	O1007RD	U9P	U9P

CROSS REFERENCE

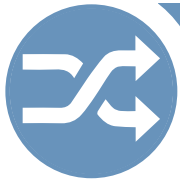

CROSS REFERENCE

DOMINION

ILCO

DOMINION	ILCO	DOMINION	ILCO	DOMINION	ILCO	DOMINION	ILCO
U9TK	TO91	UR1	BUR1	WG1	WG1	X00KC	X1001KC
UF65A	UF65A	UR10	BUR10	WH1	WH1	X00KR	X1011KR
UM2	UM2	UR11	BUR11	WH2	WH2	X199A	X1199A
UN1	UN1	UR12	BUR12	WH3	WH3	X199AR	X1199AR
UN2	MG1	UR13	BUR13	WK1	WIL1	X199B	X1199B
UN50	UN50	UR14	BUR14	WK10	WK10	X199G	X1199G
UN50L	UN50L	UR15	BUR15	WK11	WK11	X199J	X1199J
UN51	UN51	UR2	BUR2	WK12	WK12	X54F	X1054F
UN51L	UN51L	UR3	BUR3	WK13	WK13	X54FN	1054FN
UN52	UN52	UR4	BUR4	WK14	WK14	X54JA	X1054JA
UN52L	UN52L	UR5	BUR5	WK15	WK15	X54JK	X1054JK
UN53	UN53	UR6	BUR6	WK16	WK16	X54K	X1054K
UN53L	UN53L	UR62K	UR62K	WK17	WK17	X54MT	1054MT
UN54	UN54	UR62VP	UR62VP	WK18	WK18	X54WA	X1054WA
UN54L	UN54L	UR62X	UR62X	WK19	WK19	X62VK	X62VK
UN55	UN55	UR67K	UR67K	WK2	WIL2	X63	XD63
UN55L	UN55L	UR7	BUR7	WK20	WK20	X9	X999
UN56	UN56	UR8	BUR8	WK21	WK21	X9A	X999A
UN56L	UN56L	UR9	BUR9	WK22	WK22	X9B	999B
UN57	UN57	UR9CS	CS91ER	WK23	WK23	X9CS	AB62GR
UN57L	UN57L	V61	V61	WK24	WK24	X9E	BK5
UN58	UN58	V61S	V61S	WK25	WK25	X9R	X999R
UN58L	UN58L	VC21	VC21	WK26	WK26	XL1	1180S
UN59	UN59	VC22	VC22	WK27	WK27	XL2	1182
UN59L	UN59L	VC23	VC23	WK28	WK28	XR9CS	AB62G
UN60	UN60	VC24	VC24	WK29	WK29	XRU9CS	AB62ER
UN60L	UN60L	VC25	VC25	WK3	WK3	XU199B	XO1199B
UN61	UN61	VC26	VC26	WK30	WK30	XU199G	XO1199G
UN61L	UN61L	VC27	VC27	WK31	WK31	XU9CS	AB62E
UN62	UN62	VC28	VC28	WK32	WK32	Y61	Y61
UN62L	UN62L	VC29	VC29	WK4	WK4	Y62	Y62
UN63	UN63	VC30	VC30	WK5	WK5	Y9E	Y9E
UN63L	UN63L	VC31	VC31	WK6	WK6	YH1	YH1
UN64	UN64	VC32	VC32	WK7	WK7	YH10	YH10
UN64L	UN64L	VC33	VC33	WK8	WK8	YH11	YH11
UN65	UN65	VC34	VC34	WK9	WK9	YH12	YH12
UN65L	UN65L	VE1	VEC1	WR1	WAR1	YH13	YH13
UN66	UN66	VE2	VEC2	WR2	WAR2	YH14	YH14
UN66L	UN66L	VG1	VG1	WR3	WAR3	YH15	YH15
UN67	UN67	VL1	VL1	WR4	WAR4	YH16	YH16
UN67L	UN67L	VR1	VR1	WS1	WS1	YH17	YH17
UN68	UN68	VR61S	VR61S	WS10	WS10	YH18	YH18
UN68L	UN68L	VS1	VS1	WS11	WS11	YH19	YH19
UN69	UN69	VS3	VS3	WS2	WS2	YH2	YH2
UN69L	UN69L	VT1	VT1	WS3	WS3	YH20	YH20
UN70	UN70	W1	N1054WB	WS4	WS4	YH21	X18
UN70L	UN70L	W62VB	W62VB	WS5	WS5	YH22	YH22
UN71	UN71	W62VE	W62VE	WS6	WS6	YH23	YH23
UN71L	UN71L	WA1	WA1	WS7	DA20	YH24	YH24
UN72	UN72	WA2	WA2	WT1	WT1	YH25	X65
UN72L	UN72L	WB1	X55	WT2	WT2	YH26	X66
UN73	UN73	WB19	WB19	WT3	WT3	YH27	X68
UN73L	UN73L	WB2	WB2	WT4	VW67S	YH28	X67
UN74	UN74	WC1	WC1	WT5	WT5	YH29	YH29
UN74L	UN74L	WC2	WC2	WT6	PA5	YH3	YH3
UN75	UN75	WE1	WRE1	WT7	PA6	YH30	X76
UN75L	UN75L	WE2	WRE2	WT9	X88	YH31	YH31
UN76	UN76	WE3	WRE3	X00F	X1000F	YH32	X63
UN76L	UN76L	WF1	WF1	X00FR	X1000FR	YH33	X75
UN77	UN77						
UN77L	UN77L						
UN78	UN78						
UN78L	UN78L						
UN79	UN79						
UN79L	UN79L						
UN80	UN80						
UN80L	UN80L						
UN81	UN81						
UN81L	UN81L						
UN82	UN82						
UN82L	UN82L						
UN83	UN83						
UN83L	UN83L						
UN84	UN84						
UN84L	UN84L						
UN85	UN85L						
UN85L	UN85L						
UN86	UN86						
UN86L	UN86L						
UN87	UN87						
UN87L	UN87L						
UN88	UN88						
UN88L	UN88L						
UN89	UN89						
UN89L	UN89L						
UN90	UN16						
UN90L	UN16						



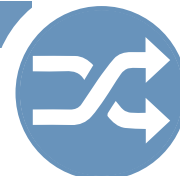

DOMINION	ILCO	DOMINION	ILCO	ESP	ILCO	ESP	ILCO	ESP	ILCO
ZE1	ZE1	ZK59	ZK59	B10	H1098LA	CO68	S1000V		
ZK1	ZK1	ZK6	ZK6	B11	O1098LA	CO7	1001EN		
ZK10	ZK10	ZK60	ZK60	B2	H1098M	CO87	1001EH		
ZK100	ZK100	ZK61	ZK61	B24	H1098X	CO89	A1001ABM	ESP	ILCO
ZK101	ZK101	ZK62	ZK62	B4	1098X	CO90	1001ABM	HY5	X196
ZK102	ZK102	ZK63	ZK63	B40	H1098A	CO91	A1001AH	IN1	1054F
ZK103	ZK103	ZK64	ZK64	B41	O1098B	CO92	A1001FH	IN18	X1054F
ZK11	ZK11	ZK65	ZK65	B42	H1098C	CO94	A1001BH	IN28	1054FN
ZK12	ZK12	ZK66	ZK66	B43	O1098D	CO95	A1001DH	IN29	1054UN
ZK13	ZK13	ZK67	ZK67	B44	P1098E	CO97	1001GH	IN3	X1054K
ZK14	ZK14	ZK68	ZK68	B45	S1098H	CO98	A1001C1	IN35	1054DL
ZK15	ZK15	ZK69	ZK69	B46	P1098J	CO99	A1001C2	IN8	L1054B
ZK16	ZK16	ZK7	ZK7	B47	S1098K	DA21	X7	JE1	OM10
ZK17	ZK17	ZK70	ZK70	B48	P1098A	DA22	X6	K2	1079B
ZK18	ZK18	ZK71	ZK71	B49	S1098B	DA23	DA23	KW1	1176
ZK19	ZK19	ZK72	ZK72	B5	1098DB	DA24	X114	KW10	A1176ST
ZK2	ZK2	ZK73	ZK73	B50	P1098C	DA25	X123	KW5	A1176
ZK20	ZK20	ZK74	ZK74	B51	S1098D	DA31	X210	L1	1004
ZK21	ZK21	ZK75	ZK75	B53	X143	DC2	X54	L37	1004KL
ZK22	ZK22	ZK76	ZK76	B55	X145	DC3	X121	L4	1004A
ZK23	ZK23	ZK77	ZK77	B56	X146	DE6	D1054K	L5	1004AL
ZK24	ZK24	ZK78	ZK78	B63	P1098CV	DE8	D1054KA	M1	1092
ZK25	ZK25	ZK79	ZK79	B64	P1098WC	E137	1137B	M10	1092N
ZK26	ZK26	ZK8	ZK8	B65	X184	EA1	1014	M11	1092H
ZK27	ZK27	ZK80	ZK80	B72	X192	EA27	X1014F	M12	1092D
ZK28	ZK28	ZK81	ZK81	B78	P1098WE	EL10	C1096CN	M13	1092DS
ZK29	ZK29	ZK82	ZK82	B84	P1101	EL11	C1096LN	M2	1092B
ZK3	ZK3	ZK83	ZK83	B86	P1106	EL3	1096L	M4	1092V
ZK30	ZK30	ZK84	ZK84	B88	P1108	ER1	1119	MB33	MB18
ZK31	ZK31	ZK85	ZK85	BE2	A1114A	ES8	1502	MB34	MB15
ZK32	ZK32	ZK86	ZK86	BM2	X59	ES8M	1502M	MD17	MD1054K
ZK33	ZK33	ZK87	ZK87	BM3	BMW1	ES9	1503	MG1	MG1
ZK34	ZK34	ZK88	ZK88	BN1	K1122D	FC2	X20	MIT1	X176
ZK35	ZK35	ZK89	ZK89	BN7	K1122N	FC5	X4	MZ10	X27
ZK36	ZK36	ZK9	ZK9	CG1	1041G	FC6	X5	MZ12	X1
ZK37	ZK37	ZK90	ZK90	CG16	1041T	FC7	X86	MZ13	X131
ZK38	ZK38	ZK91	ZK91	CG2	1041GA	FT36	F44	MZ27	X222
ZK39	ZK39	ZK92	ZK92	CG3	1041GR	FT37	FT37	MZ9	X26
ZK4	ZK4	ZK93	ZK93	CG6	1041N	FT38	FT38	NA12	1069LB
ZK40	ZK40	ZK94	ZK94	CO1	1000	GAS	1098GX	NA14	1069L
ZK41	ZK41	ZK95	ZK95	CO10	X1000G	H26	1127ES	NA24	1069LC
ZK42	ZK42	ZK96	ZK96	CO10	1000G	H27	1127DP	NA6	R1064D
ZK43	ZK43	ZK97	ZK97	CO106	1003M	H50	S1167FD	NA6	R1064E
ZK44	ZK44	ZK98	ZK98	CO2	1000AB	H51	1167FD	OP11	OP11
ZK45	ZK45	ZK99	ZK99	CO26	1000V	H54	1184FD	OP19	U62VP
ZK46	ZK46	ZU1	P1098V	CO3	1001EB	H60	1190LN	PA2	PO5
ZK47	ZK47		ESP	CO34	R1001ED	H67	1193FD	PA5	PA5
ZK48	ZK48	ESP	ILCO	CO35	R1001EE	H75	1196FD	PA6	PA6
ZK49	ZK49	AA2	X51	CO36	1001EG	HD69	X44	PA7	X32
ZK5	ZK5	AB1	AB62C	CO4	1001EA	HD70	X71	PP10	X12
ZK50	ZK50	AM1	1041C	CO44	1001MA	HD80	X129	RA3	S1970AM
ZK51	ZK51	AM3	1046	CO45	1001MB	HD90	X181	RA4	1970AM
ZK52	ZK52	AP1	101AM	CO5	1001	HD91	X182	RN24	X116
ZK53	ZK53	AP2	102AM	CO51	A1001D1	HD98	X195	RO1	1069
ZK54	ZK54	AP3	103AM	CO52	A1001D2	HL2	R1003M	RO3	1069N
ZK55	ZK55	AP4	104AM	CO58	R1001EK	HO3	1170B	RO4	1069FL
ZK56	ZK56	AR1	1179	CO6	1001AB	HR1	1014C	RO5	1069M
ZK57	ZK57	AR4	1179A	CO62	R1001EG	HR2	TE3	RU1	1011
ZK58	ZK58	B1	1098M	CO66	A1001EH	HY2	X160	RU16	A1011P

CROSS REFERENCE

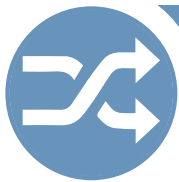

ESP	ILCO	ESP	ILCO	FALCON	ILCO	HUDSON	ILCO	ILCO/EZ	ILCO
VL5		VL5	X29	KB1577N	A1054WN	H07L	1564	BAU1R	1618R
VL6		VL6	X80	KB1577P	A1054WP	H10L	1561	BAU2	1648
WE1		WE1	1123	KB1577R	A1054WR	670-12,H21	R1003M	BAU3	1676
WE3		WE3	1123S	P1573E	1054WC	ILCO/EZ		BAU3	1676
RU18	1011PZ	WK2	1175N	P1577E	A1054WC	ILCO/EZ	ILCO	BE2	A1114A
RU19	1011D41	WR3	1054WB	P1581E	L1054WC	AF1	1652	BN1	K1122D
RU2	1012	WR4	A1054WB	FORT LOCK		AM1	1041C	BO1	R1003M
RU20	A1011D41	WR5	N1054WB	FORT LOCK	ILCO	AM3	1045	BW2	1510
RU21	N1011M	WS2	FT6R	K54G	1054G	AM3L	1045L	CG1	1041G
RU22	A1011M	XL7	1180S	K750D	750	AM4	1653	CG16	1041T
RU4	N1011P	Y1	999	K752	752	AP1	101AM	CG17	1041Y
RU45	1011D1	Y103	O1122B	K757	757	AP2	102AM	CG2	1041GA
RU46	A1011D1	Y104	O1122BR	KL54G	L1054G	AP3	103AM	CG22	1041E
S1	1009	Y11	O1122	M54G	M54G	AP4	104AM	CL1	1023
S16	N1007KMB	Y12	O1122A	ML54G	ML54G	AP5	100AM	CLB1	1573A
S22	O1007LA	Y13	O1122R	GENERAL		AR1	1179	CLB10	1589J
S22 1/2	1007LA	Y14	O1122AR	GENERAL	ILCO	AR1SC	1179SC	CLB11	1590K
S3	1010	Y149	S1767CH	100-A1	G191	AR4	1179A	CLB12	1591L
S31	N1007RMA	Y152	1770CH	100-A10	G190	ASS32-SI	AS6	CLB13	1591M
S32	N1007RMB	Y154	P1789	100-A2	G192	B1	1098M	CLB14	1591N
S4	1010U	Y155	P1793	100-A29	G190B	B10	H1098LA	CLB15	1591P
S4	O1010	Y157	P1794	100-A3	G193	B102	P1113	CLB2	1573B
S6	N1007KMA	Y1E	999N	100-A30	G190C	B106	P1115	CLB3	1573C
S68	1010N	Y2	999A	100-A31	G190D	B11	O1098LA	CLB4	1573D
S69	L1010N	Y220	999B	100-A32	G190E	B110	P1114	CLB5	1573E
SB11	X52	Y3	C999	100-A33	G190F	B16	H1098DB	CLB6	1573F
SC1	1145	Y4	998	100-A4	G194	B2	H1098M	CLB7	1581G
SC10	A1145F	Y52	997E	100-A5	G195	B24	H1098X	CLB8	1581H
SC20	A1145L	Y54	O997E	100-A6	G196	B3	1098L	CLB9	1589I
SC22	1307W	Y6	997X	100-A7	G197	B4	1098XL	CO1	1000
SC4	1145A	YS1	X21	100-A8	G198	B44	P1098E	CO10	X1000G
SC6	1307A	YS2	X22	100-A800	G190M	B45	S1098H	CO102	A1001C2
SC7	1145F	FALCON		100-A9	G199	B46	P1098J	CO106	1003M
SC8	1145E	FALCON	ILCO	101-A1	G191A	B47	S1098K	CO107	A1001D1
SC9	A1145E	12628A	FL1	101-A10	G190A	B48	P1098A	CO108	A1001D2
SE1	1022	12628B	FL2	101-A2	G192A	B49	S1098B	CO12	1000T
SK1	R1001EN	12628BD	FL4	101-A29	G190BA	B5	1098DB	CO17	1000F
SL1	1120D	12628D	FL3	101-A3	G193A	B50	P1098C	CO26	1000V
T7	1141GE	FALCON	ILCO	101-A30	G190CA	B51	S1098D	CO3	1001EB
TR20	T61C	12628E	FL5	101-A31	G190DA	B52	1098GX	CO35	R1001EE
TR23	T61F	12628F	FL6	101-A32	G190EA	B62	P1098AV	CO36	1001EG
TR25	TR25	12628G	FL7	101-A33	G190FA	B63	P1098CV	CO4	1001EA
TR28	X37	12628H	FL8	101-A4	G194A	B64	P1098WC	CO5	1001
TR33	X137	12628J	FL9	101-A5	G195A	B67	S1098WD	CO2	R1001EG
TR37	X159	KB1573G	1054WD	101-A6	G196A	B68	P1099	CO3	1000X
TR39	X151	KB1573H	1054WH	101-A800	G190MA	B77	P1098EV	CO68	S1000V
TR40	X174	KB1573K	1054WF	HARLOC		B78	P1098WE	CO7	1001EN
TR47	X217	KB1573K	1054WK	HARLOCK	ILCO	B79	S1098WH	CO87	1001EH
UN16	UN16	KB1573L	1054WL	SE-1	1014B	B84	P1101	CO88	A1001EH
UN18	62FS	KB1573N	1054WN	SE-1	1014C	B85	S1105	CO89	A1001ABM
UN3	62DP	KB1577F	A1054WF	HYM/YORK		B86	P1106	CO9	1000KC
V26K	V27	KB1577G	FL5G	HYM/YORK	ILCO	B88	P1108	CO91	A1001AH
V28M	VW71	KB1577G	A1054WD	S2801	1133	B89	P1107	CO92	A1001FH
V29R	VW71A	KB1577H		S4404	1135	B91	P1111	CO94	A1001BH
V30F	X9	A1054WH		HUDSON		B92	P1109	CO95	A1001DH
V32FB	X53	KB1577J	A1054WJ	HUDSON	ILCO	B93	P1112	CO97	1001GH
V35	X139	KB1577K	A1054WK	H02L	1562	B94	K1995-B94	CO98	A1001C1
VL3	VO62	KB1577L	A1054WL	H03L	1563	B96	P1110	CR105	A1011-L41
VL4	X30					BAU1	1618	CR45	CR45





ILCO/EZ	ILCO	ILCO/EZ	ILCO	ILCO/EZ	ILCO	ILCO/EZ	ILCO	ILCO/EZ	ILCO
CR46	CR46	HAW5	1683	M5	1092VM	SC22	1307W		
CR87	CR87	HO1	1170B	MD17	MD1054K	SC4	1145A		
CR88	CR88	HO4	A1170B	N1	1017	SC4	EZ5		
CR89	CR89	HR1	1014C	N3	1017B	SC6	1307A	ILCO/EZ	ILCO
CR91	CR91	HR2	TE3	NA1	1064	SC7	1145F	Y13	01122R
DE1	1054KD	IL1	1041H	NA12	1069LB	SC8	1145E	Y133	X1199AR
DE2	D1098B	IL11	1043J	NA14	1069L	SC9	A1145E	Y138	S1767CH
DE4	D1098X	IL9	1043B	NA24	1069LC	SE1	1022	Y14	01122AR
DE5	A1054KD	IN1	1054F	NA25	R1064E	SE2	1022	Y146	1767CH
DE6	D1054K	IN18	X1054F	NA6	R1064D	SK1	R1001EN	Y149	S1770U
DE8	D1054KA	IN2	1054	NH1	1177N	SL1	1120D	Y152	P1770U
DE9	DS1145	IN24	K1054B	OL1	1171P	SL20	1120F	Y153	P1786
EA1	1014	IN28	1054FN	P1	1016	SS4	1626	Y154	P1789
EA13	1014DX	IN29	1054UN	P2	1016N	SS5	1637	Y155	P1793
EA27	X1014F	IN3	X1054K	PZ1	PZ1	ST4	1145AST	Y157	P1794
EA32	1014J	IN33	1054MT	R3	1140G	T1	1141	Y159	P1795
EL1	1096C	IN34	1054TW	RA1	1098NR	T2	H1122M	Y1E	999N
EL10	C1096CN	IN35	1054DL	RA2	H1098NR	T7	1141GE	Y2	999A
EL11	C1096LN	IN36	N1054K	RA3	S1970AM	TM1	1601	Y220	999B
EL15	L1096CN	IN4	1054LB	RA4	1970AM	TM10	1610	Y221	999K1
EL2	1096	IN8	L1054B	RE1	1019	TM12	1612	Y222	999K2
EL20	S1096B	K1	1079	RO1	1069	TM13	1621	Y3	C999
EL21	R1096EN	K2	1079B	RO15	N1069N	TM14	1622	Y34	997DA
EL3	1096L	KB1	1649	RO3	1069N	TM15	1623	Y4	998
EL8	H1054B	KB2	1654	RO4	1069FL	TM16	1650	Y5	997EB
ER1	1119	KB3	1663	RO5	1069M	TM17	1651	Y52	997E
ES9	1503	KW1	1176	RO7	1069G	TM18	1665	Y54	O997E
EZ1	1522	KW1	EZ1	RU1	1011	TM19	1666	Y6	997X
EZ2	1647	KW10	A1176ST	RU101	RU101	TM2	1602	Y78	998GA
FA1	1054WC	KW11	A1176KT	RU16	A1011P	TM20	1667	Y9	H1122F
FA2	A1054WC	KW5	A1176	RU2	1012	TM3	1603		
FA3	A1054WD	L1	1004	RU3	1011B	TM4	1604	ILLINOIS	ILLINOIS
FIC1	1617	L13	1004N	RU4	1011P	TM6	1606	100	S1041H
FIC3	1681	L4	1004A	RU44	1011GH	TM7	1607	105	ILL1
GH5	1682	LD1	1639	RU45	1011D1	TM8	1608	110	1041H
FR2	L1054G	LD2	1640	RU46	A1011D1	TM9	1609	115	1041HM
H18	1127DU	LO1	X1014L	RU52	N1011P	VR2	VR91	210	S1042Z
H26	1127ES	LUV1	P1098V	RU53	A1011D41	VR5	VR91B	210	S1042ZP
H27	1127DP	M1	1092	RU7	N1011M	VR7	VR91AR	220	1042Z
H5	1125H	M1	EZ4	S1	1009	W1	1071	220	S1042ZS
H50	S1167FD	M10	1092N	S10	1010B	WE1	1123	260	1043D
H51	1167FD	M11	1092H	S16	S16	WK1	1175	265	1043E
H52	S1181FD	M12	1092D	S2	1009	WK2	1175N	270	1043G
H53	1181FD	M13	1092DS	S22	S22	WN1	1634	275	1043ED
H54	1184FD	M14	1092J	S22 1/2	S22 1/2	WN2	1686	310	1041P
H55	1185FD	M16	1092NR	S3	1010	WR2	X1054WA	360	1043B
H56	1186TS	M17	1092C	S31	S31	WR3	1054WB	510	1042A
H6	1125	M18	1092-40	S32	S32	WR4	A1054WB	610	1042B
H60	1190LN	M19	1092-900	S4	1010	WR5	N1054WB	210M	S1042ZM
H62	1191ET	M2	1092B	S5	1009A	WR5	EZ3	360M	1043C
H66	1193MU	M20	1092-6000	S6	S6	WR6	N1176	610X	L1042B
H67	1193FD	M21	1092-7000	S68	1010N	WTP1	1616	X410	1041W
H71	1195FD	M25	1092-6000B	S70	S70	WTP2	1662		
H75	1196FD	M26	1092-7000B	S73	S73	XL7	1180S	JET	JET
H78	1196CM	M27	1092F	SA1	1047CR	Y1	999	191	VR91AR
HAW1	1597	M28	1092K	SC1	1145	Y101	L1122A	057AD-6-NP	R1001EM
HAW2	1598	M29	1092M	SC1	EZ2	Y103	01122B	100C-NP	100C
HAW3	1599	M3	1092VR	SC10	A1145F	Y11	1122	100C-NS	100C-NS
HAW4	1600	M4	1092V	SC20	A1145L	Y12	01122A	100E-NS	100E-NS

CROSS REFERENCE



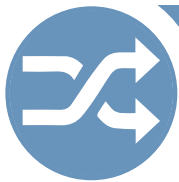

CROSS REFERENCE

JET

ILCO

101CE-NS A1145CE
 101C-NP 101C
 101C-NS 101C-NS
 101EF-NS A1145EF
 101E-NP 101E
 101E-NS 101E-NS
 101FG-NS A1145FG
 101F-NS 101F-NS
 101G-NS A1145G
 101H-NS A1145H
 11GB-NS 998GB
 11GC-NS 998GC
 11GD-NS 998GD
 11GE-NS 998GE
 11GF-NS 998GF
 11GG-NS 998GG
 11GH-NS 998GH
 11GK-NS 998GK
 11SA-NS 998SA
 11SB-NS 998SB
 11SC-NS 998SC
 11SD-NS 998SD
 11SE-NS 998SE
 11SF-NS 998SF
 11SG-NS 998SG
 11SH-NS 998SH
 11SK-NS 998SK
 11SMK-NS 998SMK
 137B 1137B
 137S 1137S
 191B VR91B
 1A1A1-NS 1A1A1
 1A1B1-NS A1114B
 1A1B1-NS 1A1B1
 1A1C1-NS A1114C
 1A1C1-NS 1A1C1
 1A1D1-NS A1114D
 1A1D1-NS 1A1D1
 1A1DD1-NS A1114DD
 1A1E1-NS A1114E
 1A1E1-NS 1A1E1
 1A1F1-NS A1114F
 1A1F1-NS 1A1F1
 1A1G1-NS A1114G
 1A1G1-NS 1A1G1
 1A1H1-NS A1114H
 1A1H1-NS 1A1H1
 1A1J1-NS A1114J
 1A1J1-NS 1A1J1
 1A1K1-NS A1114K
 1A1K1-NS 1A1K1
 1A1L1-NS A1114L
 1A1L1-NS 1A1L1
 1A1M1-NS A1114M

JET **ILCO**
 1A1M1-NS 1A1M1
 1A1Q1-NS A1114Q
 1A1Q1-NS 1A1Q1
 1A1R1-NS A1114R
 1A1R1-NS 1A1R1
 1A1TB1-NS A1114TB
 275RF-NS 1007RF
 275RG-NS 1007RG
 54G 1054G
 57A1-6-NSR1001EE
 57A2-6-NS 1001MB
 57B1-6-NS 1001MA
 57B2-6-NSR1001ED
 59A2-6-NS A1012-59A2
 59B1-6-NS A1012-59B1
 59B2-6-NS A1012-59B2
 59C1-6-NS A1012-59C1
 59C2-6-NS A1012-59C2
 59D1-6-NS A1012-59D1
 59D2-6-NS A1012-59D2
 6275LA-NS 6275LA
 6275LB-NS O1007LB
 6275LC-NS O1007LC
 6275LD-NS O1007LD
 6275LE-NS O1007LE
 6275LF-NS O1007LF
 6275LG-NS O1007LG
 6275LH-NS O1007LH
 6275LJ-NS O1007LJ
 6275LK-NS O1007LK
 6275LL-NS O1007LL
 6275LM-NS O1007LM
 6275RA-NS O1007RA
 6275RB-NS O1007RB
 6275RC-NS O1007RC
 6275RD-NS O1007RD
 6275RE-NS O1007RE
 6275RF-NS O1007RF
 6275RG-NS O1007RG
 6275RH-NS O1007RH
 6275RJ-NS O1007RJ
 6275RK-NS O1007RK
 6275RL-NS O1007RL
 6275RM-NS O1007RM
 8260KW-NS 08260KW
 8-NS 8-YALE-NS
 A191 AG2
 A192 A192
 AB1 AB62C
 AB3 AB62ER
 AB4 AB62E
 AIR 5-NS 1515
 AIR 6-NS A1515
 AM1 1041C
 AM3 1046
 AM6 1045
 AM7 A1045
 AR1 1179
 AR-1C-NS B1179-1C

JET **ILCO**
 AR-1D-NS B1179-1D
 AR3 or K6-NS N1179A
 AR4 1179A
 AR-ER A1019M
 B1 1098M
 B10 or B10-NPH1098LA
 B102 P1113
 B102-PH B102-P
 B103-N-PHT B103-PT5
 B103-PHT B103-PT
 B11 O1098LA
 B2 or B2-NP H1098M
 B4 1098XL
 B44 P1098E
 B44-PH B44-P
 B45 S1098H
 B45-PH B45-P
 B46 P1098J
 B47 S1098K
 B48 P1098A
 B48-PH B48-P
 B49 S1098B
 B49-PH B49-P
 B5 1098DB
 B50 P1098C
 B50-PH B50-P
 B51 S1098D
 B51-PH B51-P
 B52 or GAS 1098GX
 B53-NP X143
 B54-NP X154
 B55-NP X145
 B56-NP X146
 B59-NP X162
 B61-NP X168
 B62 P1098AV
 B63 P1098CV
 B64 P1098WC
 B65-NP X184
 B67 S1098WD
 B68 P1099
 B69-NP X180
 B72-NP X192
 B77 P1098EV
 B78 P1098WE
 B79 S1098WH
 B84 P1101
 B86 P1106
 B86-PH B86-P
 B88 P1108
 B89 P1107
 B91 P1111
 B91-PH B91-P
 B92 P1109
 B93 P1112
 B96-NP P1110
 B96-PH B96-P
 B106-NP P1115-B106
 B112-CP-PHT B111-PT

JET **ILCO**
 B114-PHT B114R-PT
 BE2 or 1A1A1- NSA1114A
 BMW1 BMW1
 BMW3-NP X144
 BMW3-PH BMW3-P
 BN1-NP K1122D
 CB1 1573A
 CB10 1589J
 CB11 1590K
 CB12 1591L
 CB13 1591M
 CB14 1591N
 CB15 1591P
 CB2 1573B
 CB3 1573C
 CB4 1573D
 CB5 1573E
 CB6 1573F
 CB7 1581G
 CB8 1581H
 CB9 1589I
 CCL1 CB3
 CG1 1041G
 CG16 1041T
 CG2 1041GA
 CG22 1041E
 CG4 1041GB
 CL1 1023
 CLP1-NP 1537
 CO1 1000
 CO10 X1000G
 CO17 SX1000F
 CO19 1000FR
 CO19 X1000F
 CO2 1000A
 CO26 1000V
 CO3 1001EB
 CO33 1001E
 CO36 1001EG
 CO37 1001EL
 CO4 1001EA
 CO5 1001
 CO51 A1001D1
 CO52 A1001D2
 CO54 1/2 X1000FR
 CO6 1001AB
 CO62 OR 77-6-NS
 CO68 S1000V
 CO7 1001EN
 CO87 1001EH
 CO88 A1001EH
 CO89 A1001ABM
 CO90 1001ABM
 CO91 A1001AH
 CO92 A1001FH
 CO94 A1001BH
 CO95 A1001DH
 CO97 1001GH

JET **ILCO**
 CO98 A1001C1
 CO99 A1001C2
 CO-KW1 1001MK
 CR45 CR45
 CR45 1012-D1
 CR46 CR46
 CR87 CR87
 CR87 1012-60
 CR88 CR88
 CR88/60-6-NS A1012-60
 CR91 CR91
 CR91/59A1-6-NS
 A1012-59A1
 CR-L4-5 1011-L4
 CR-L4-6 A1011-L4
 D1-6-NS or CR46
 A1012-D1
 D2-6-NS A1012-D2
 D3-6-NS A1012-D3
 D4-6-NS A1012-D4
 D8780 S1069G
 D8782 1069S
 D8783 1069G
 D8784 S1069M
 D8785 1069N
 D8787 1069FL
 D8788 1069M
 D8789 1069E
 DA21-NP X7DA22-
 NP OR SR1-NP X6
 DA23-NP DA23
 DA24-NP X114
 DA25-NP X123
 DA25-PH DA25-P
 DA28-NP X124
 DA31-NP X210
 DA31-N-PHT
 NSN11T2
 DA31-PH DA31-P
 DA34-N-B EB3-H-NI02
 DA34-N-PHTEK3-NI02
 DA34-NP X237
 DA34-PH DA34-P
 DA37-PH DA37-P
 DA40-PHT NI04T
 DC2-NP X54
 DC3-NP X121
 DE6 D1054K
 DE8 D1054KA
 DIE-1-NS 1028L
 DIE-2-NS 1052A
 DIE-3-NS 1028
 DO6 DO6
 DW47-N-PHT DW05T5
 DW47-PH DW05AP
 DW47R-N-PHT DW05RT5
 DW47R-PH DW05RAP
 E42DN 1548
 EA27 X1014F





JET	ILCO	JET	ILCO	JET	ILCO	JET	ILCO	JET	ILCO
EA27	X1014L	H86-PH	H86-PT	IL210	S1042ZP	L3-6-NS	A1011-L3		
EA47	O1014S	H90-N-B	EB3-D-H84	IL210M	S1042ZM	L37	1004KL		
EM1	1528	H90-N-PHTEK3-H84		IL220	1042Z	L4	1004A		
EM1R	1528R	HD103-NP	X214	L220	S1042ZS	L41-NS-6	A1011-L41	JET	ILCO
ES1	1556	HD103-PH	HD103-P	IL260	1043D	CR-L41-6	A1011-L41	MOS-3-NS	1115
ES8	1502	HD106-N-PHT		IL360	1043B	L4-6-NS	A1011-L4	MOS-4-NS	884BR
ES8M	1502M		HD106-PT5	IL360	1043J	CR-L4-6	A1011-L4	MOS-5-NS	1323
ES9	1503	HD70,71-NPNS	X71	IL510	1042A	L5	1004AL	MZ9-NP	X26
EZ1	1522	HD74-NP	X84	IL510	L1042A	L54G	L1054G	MZ13-NP	X131
FA1	1054WC	HD75-NP	X138	IL610	1042B	L6M	A1015M	MZ13-PH	MZ13-P
FA2	A1054WC	HD82-NP	X129	IL610	L1042B	L6MR	A1015MR	MZ16-NP	X178
FA3	A1054WD	NSHD83,90-PHN	S	IN1	1054F	L7M	L1015M	MZ17-NP	X188
FC7-NP	X86		HD90-P	IN18	X1054F	L7MR	L1015MR	MZ19-NP	X201
FT36	F44	HD83-NP	X181	IN20	1054K	LEB-1-NS	LB1	MZ19-PH	MZ19-P
FT36-NP	NE9	HD90-NP	X181	INFQ45-PHT	INF45-PT	LEB-2-NS	LB2	MZ27-NP	X222
FT37-NP	FT37	HD91-NP	X182	IN28	1054FN	LEB-3-NS	LB3	MZ27-PH	MZ27-P
FT38-NP	FT38	HD91-PH	HD91-P	IN29	1054UN	LEB-4-NS	LB4	MZ31-NP	X249
FT46-NP	X152	HD92-NP or HD84-		IN3	X1054K	LEB-6-NS	LB6	MZ34-N-B	EB3-J-MAZ24
GM97-N-PHT	B97-PT5	NP	X183	IN33	1054MT	LEB-7-NS	LB7	MZ34-N-PHT	EK3-MAZ24
GM97-PHT	B97-PT	HD96-NP	X193	IN35	1054DL	LO80-5	80	NA12	1069LA
GM99NPHT	B99-PT	HD98-NP	X195	IN8	L1054B	LR191A	VR91R	NA12	1069LB
GM99-N-PHT	B99-PT5	HD103-PH	D103-SVC	INF90-PH	INF90	LXP90-PH	LXP90-P	NA14	1069L
GMX320-PHT	B112-PT	HD106-N-PHT	H D106-PT	K1	1079	M1	1092	NA24	1069LC
GMT265-PHT	B115-PT	HD110-N-PHT	HO01-PT	K100M	100AM	M10	1092N	NA6	R1064E
GMX380CP-PHT		HD112-PHT	HO03-PT	K101	101AM	M11	1092H	NH1	1177N
	B111-GCPT	HD113-PHT		K102	102AM	M12	1092D	O4KA	1004K
H50	S1167FD		HD111-PT	K103	103AM	M13	1092DS	O4KA	X1054KF
H50F-NP	H50F	HHM-1-NS	1028N	K104	104AM	M19	1092J	O59AD-6	A1001GRM
H50L-NP	H50L	HHM-2-NS	1133	K2	1079B	M1-RV	1092R	O59AD-7L	1001GRM
H51	1167FD	HK1	1597	K7-NS	K7	M2	1092B	P54F	P54F
H51F-NP	H51F	HK2	1598	KA14-NP	X103	M27	1092NR	PR7	PR91C
H51L-NP	H51L	HK3	1599	KA15-NP	X106	M3	1092VR	PU1	1866-13
H54	1184FD	HK4	1600	KA31-NP	KW16CP-SI	M4	1092V	PZ1	PZ1
H55	1185FD	HL1	1003M	KB577E-NS	P1577E	M5	1092VM	R52	A1
H56-PH	1186TS-P	HL2	R1003M	KB577F-NS	A1054WF	M6000	1092-6000	R52L	A2
H60	1190LN	HR1	1014C	KB577G-NS	KB1577G	M6000B	1092-6000B	R55	A3
H60L-NP	H60L	HR2	TE3	KB577J-NS	A1054WJ	M7000	1092-7000	R55	1551
H62F-PH	H62F	HU66VW-N-PHT	HU66AT2	KK1-NP	X233	M7000B	1092-7000B	R59	TE1
H62-PH	H62-P	HU66VW-N-PHT	HU66AT5	KP1	1041Y	M900	1092-900	R59	TE4
H65 OR H65-NP	X221	HU66VW-PH	HU66-P	KP2	SC1041R	MAZ24-N-PHT		RA3	S1970AM
H65-PH	H65-P	HU67-PHT	HU66T6	KP9	S1041JA	MAZ24RT5		RA4	1970AM
H67	1193FD	HU68-PHT	HU66T24	KW1	1176	MB16-NP	MB16	RN24-NP	X116
H67F-PH	H67F	HY12-NP	X232	KW10 or KW10-NP		MB41-NP	X82	RN30-NP	X147
H67-PH	H67-P	HY12-PH	HY12-P		A1176ST	MD17	MD1054K	RO1	1069
H71	1195FD	HY13-NP	X235	KW1-PHC	KW1-PC	MIT1-NP	X176	RU1	1011
H72-PHT	H72-PT	HY13-PH	HY13-P	KW5	A1176	MIT1-PH	MIT1-P	RU16	A1011P
H72-PHT-T		HY14-NP	X236	KW9-RT	1176RK	MIT3-NP	X224	RU18	1011PZ
	H72-PT-CLEAR	HY14-PH	HY14-P	L01ABM	L1001ABM	MIT4-NP	X245	RU18 1/2	A1011PZ
H72-N-B	EB3-B-H72	HY2-NP	X160	L01EH	L1001EH	MIT4-PH	MIT4-P	RU19	1011D41
H72-N-PHTEK3-H72		HY2-PH	HY2-P	L07KMA	N1007KMC	MIT12-N-B	EB3-K-MIT8	RU20	A1011D41
H73-PHT	H73-PT	HY4-NP	X187	L1	1004	MIT12-N-PHT	EK3-MIT8	RU21	N1011M
H74-PHT	H74-PT	HY5-NP	X196	L11D1	B1011D1	MIT12-PHT	MIT12-PT	RU22	A1011M
H75	1196FD	HY6-NP	X216	L11D41	B1011D41	MIT13-N-B	EB3-L-MIT9	RU4	N1011P
H75F-NP	H75FM	HY12-PH	KK6-P	L11P	1011PAA	MIT13-N-PHT	EK3-MIT9	RU45	1011D1
H75F-PH	H75F	HY15-PH	HY15-P	L12-6-NS	A1011-L12	MIT13-PHT	MIT13-PT	RU46	A1011D1
H75-PH	H75-P	HY16-PH	HY16-P	L1-6-NS	A1011-L1	MIT16-PHT	MIT16A-PT	S&G-1-NS	1063D
H76 OR H76-NP	X244	HY17-PH	HY17-P	L191A	VR91	MIT17-PHT	MIT17A-PT	S&G-2-NS	1063B
H76F-PH	H76F	IL1	1041H	L2-6-NS	A1011-L2	MOS-1-NS	1091	S&G-3-NS	1063E
H78	1196CM	IL210	S1042Z	L34-6-NS	A1011-L34	MOS-2-NS	1323L	S1	1009

CROSS REFERENCE



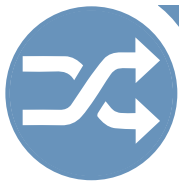

CROSS REFERENCE

SEC 10 PG 426

JET		ILCO		JET		ILCO		JET		ILCO		MASTER		ILCO	
TM110		1610		WR6	A1054WB	YOR-2-NS	1028D	130K		1092DS					
TM130		1608		XL7	1180S	YU1-NP	X153	150K		1092D					
TM150		1609		Y1 or 8-NP	999	YU2-NP	X167	15K		1092N					
TM180		1607		Y103	O1122B	KWIKSET		17K		1092H					
S16	N1007KMB	TM200	1604	Y11	O1122	KWIKSET	ILCO	19K		1092J					
S22 1/2LA	1007LA	TM300	1601	JET	ILCO	1-1063	1176	1K		1092					
S22-LA	O1007LA	TM400	1602	Y12	O1122A	08260KW	A1176ST	22KL		1286B					
6275LA-NS	O1007LA	TM700	1606	Y13	O1122R	KIOTI		22KR		1286BR					
S30FD-N-PHTFO21EH2		TMC1-NP	X270-TMC1	Y14	O1122AR	KIOTI	ILCO	27K		1092NR					
S31	N1007RMB	TR20-NP	T61C	Y149	S1768CH	T5515-75192	1694	2K		1092R					
S32	N1007RMA	TR20-PH	T61C-P	Y149	S1770U	T4625-75191	1695	500KL		1286E					
6270RN-NS	N1007RMA	TR23-NP	T61F	Y152	1768CH	T2545-41151	1696	500KR		R1286E					
S34YS-PH	S34YS-P	TR25	TR26	Y152	P1770U	T2540-41151	1696	510K		N1286R					
S4	1010U	TR25-NP	TR25	Y153	P1786	T4520-75192	1696	52K		1092-52					
S48HF-PH	S48HF-P	TR33-NP	X137	Y153-PH	Y153-P	LOCKWOOD		600K		1092-600A					
S50HF-PH	S50HF-P	TR33-PH	TR33-P	Y154	P1789	LOCKWOOD	ILCO	7K		1092B					
S54F	S54F	TR37-NP	X159	Y154C-NP	Y154CHY	50	1015	81KM		1092VM					
S6 or 6270LN-NS		TR37-PH	VC33	Y154C-PH	Y154PCHY	51	1015A	81KR		1092V					
	N1007KMA	TR39-NP	X151	Y154-PH	Y154-P	101B	1006	ORION							
S66NN-PH	S66NN-P	TR40-NP	X174	Y155	P1793	306B	1005	ORION		ILCO					
S68	1010N	TR40-PH	TR40-P	Y155C-NP	Y155CHY	54K	1015C	1000V		1000V					
S69	L1010N	TR44-NP	X211	Y155C-PH	Y155PCHY	A317L	A1015L	1001AH		1001AH					
S7BW-PH	S7BW-P	TR46-NP	X212	Y155-PH	Y155-P	B308	1004	1001EB		1001EB					
SAA1-NP	X52	TR47-NP	X217	Y155V	1793V	B308R	1004R	1001EG		1001EG					
SC1	1145	TR47-PH	TR47-P	Y157	P1794	B310	1004A	1001EH		1001EH					
SC10	A1145F	TR47-PHT	TOY43AT4	Y157C-NPY	Y157CHY	B310R	1004AR	1001EN		1001EN					
SC19 or 100L-NS	1145L	TR47-N-B		Y157C-PH	Y157PCHY	B315M	1015M	1001GRM		1001GRM					
SC1-PHC	SC1-PC		EB3-E-TOY43	Y157-PH	Y157-P	B317M	A1015M	1003M		1003M					
SC20 OR 101L-NS	A1145L	TR48-N-B		Y157V or Y159V	1794V	B317N	A1015N	1004AXM		1004AXM					
SC22	1307W		EB3-F-TOY48	Y159	P1795	B317P	A1015P	1004K		1004K					
SC4	1145A	TR48-N-PHT	EK3-TOY48	Y159C-NPY	Y159CHY	B317Q	A1015Q	1004N		1004N					
SC6	1307A	TR49-N-B		Y159C-PH	Y159PCHY	B317R	A1015R	1007LA		1007LA					
SC7	1145F		EB3-G-TOY40	Y159-PH	Y159-P	B317S	A1015S	1007LB		1007LB					
SC8	1145E	TR49-N-PHT	EK3-TOY40	Y160-N-B	EB3-A-Y160	B317T	A1015T	1007LC		1007LC					
SC9	A1145E	TR51-PHT	TOY44D-PT	Y160-N-PHTEK3	Y160	B317U	A1015U	1007LD		1007LD					
SCH-3	EH3	TR51-N-PHT	EK3-TOY43	Y165-PHT	Y164-PT	B317V	A1015V	1007LDH		1007LDH					
SE1 or SE1-NP	1022	TR53-NP	X223	Y166-PHT	Y170-PT	B317W	A1015W	1007LDM		1007LDM					
SE8	1022AB	TR60-PHT	TOY50-PT	Y1E	999N	B317X	A1015X	1007LE		1007LE					
SK1	R1001EN	V26K-NP	VW67	Y1R	999R	B317Y	A1015Y	1007LF		1007LF					
SK4	R1001EL	V28M-NP	VW71	Y2 or 11-NP	999A	B318L	A1015LR	1007LG		1007LG					
SKY 5-NS	1517	V29R-NP	VW71A	Y220	999B	B318M	A1015MR	1007LH		1007LH					
SKY 6-NS	A1517	V30-NP	X9	Y221	SX9B	B318N	A1015NR	1007LHM		1007LHM					
SL1	1120D	PA8-NP	X9	Y227	998GST	B318P	A1015PR	1007LJ		1007LJ					
SR8-N-B	EB3-P-SUB4	V37-NP	X203	Y4 or 11GMK-NS	998	B318Q	A1015QR	1007LK		1007LK					
SR8-N-PHT	EK3-SUB4	V37-PH	V37-P	Y5	997EB	B318R	A1015RR	1007LL		1007LL					
SR9-N-B	EB3-N-SUB1	VL4-NP	X30	Y52	997E	B318S	A1015SR	1007LM		1007LM					
SR9-N-PHT	EK3-SUB1	VL6-NP	X80	Y52/Y52E	997D	B318T	A1015TR	1007RA		1007RA					
SUZ11-NP	X87	VL8-NP	X140	Y54 or Y54E	O997E	B318U	A1015UR	1007RB		1007RB					
SUZ17-NP	X186	WB1A	1071	Y6 or Y6E	997X	B318V	A1015VR	1007RC		1007RC					
SUZ18-NP	X241-SUZ18	WB1B	1071BD	Y78 or 11GA-NS	998GA	B318W	A1015WR	1007RD		1007RD					
SW1	1534	WB1C	1071BE	YAL-1-NS	885BL	B318X	A1015XR	1007RDH		1007RDH					
T146	1270D	WB2A	1071A	YAL-2-NS	1095	B318Y	A1015YR	1007RDM		1007RDM					
T21	O1225N	WB2B	1071D	YAL-3-NS	1095HL	B325	1004N	1007RE		1007RE					
T23	1270C	WB2C	1071E	YH38-NP	X77	B346	1004AL	1007RF		1007RF					
T26	1242L	WE1	1123	YH46-NP	X120	B346KL		1007RG		1007RG					
T3	1141E	WK2	1175N	YH47-NP	X119	MASTER		1007RH		1007RH					
T3NR	1550	WR3	1054WB	YH48/50-NP	X117	MASTER	ILCO	1007RHM		1007RHM					
T7	1141GE	WR5	N1054WB	YH49/51-NP	X118	1525	1092VA	1007RJ		1007RJ					
TM100	1603	WR5-PHC	WR5-PC	YOR-1-NS	1028AY	105K	1286C	1007RK		1007RK					





ORION	ILCO	ORION	ILCO	ORION	ILCO	ORION	ILCO	ORION	ILCO
1007RL	1007RL	1092N	1092N	A1001DH	A1001DH	A1114R	A1114R		
1007RM	1007RM	1092NR	1092NR	A1001EH	A1001EH	A1145CE	A1145CE		
100AM	100AM	1092R	1092R	A1001FH	A1001FH	A1145E	A1145E		
1010N	1010N	1092V	1092V	A1001GRM	A1001GRM	A1145EF	A1145EF	ORION	ILCO
1011	1011	1092VA	1092VA	A101MJ	A101MJ	A1145F	A1145F	A34B	AR61T
1011D1	1011D1	1092VM	1092VM	A1001MJRA	A1001MJR	A1145FG	A1145FG	A34E	A61Q
1011D12	1011D12	1092VR	1092VR	A1001-10N	A1001-10N	A1145G	A1145G	A34F	AR61Q
1011D2	1011D2	1096C	1096C	A1011-11N	A1011-11N	A1145H	A1145H	A34G	AS2
1011D3	1011D3	10961	10961	A1011-12N	A1011-12N	A1145J	A1145J	A34K	AS6
1011D34	1011D34	1098JD	1098JD	A1011-13N	A1011-13N	A1145K	A1145K	A34L	AS8
1011D4	1011D4	1098X	1098X	A1011-15N	A1011-15N	A1145L	A1145L	A34M	AS4
1011D41	1011D41	1120D	1120D	A1011-16N	A1011-16N	A1176ST	A1176ST	A34N	A61W
1011P	1011P	1120F	1120F	A1011-17N	A1011-17N	A28A	61T	A34P	AR61W
1011PZ	1011PZ	1120G	1120G	A1011-18N	A1011-18N	A28B	R61T	A34R	AS26
1014C	1014C	1123	1123	A1011-19N	A1011-19N	A28E	61Q	A34RC	AS14L
101AM	101AM	1141GE	1141GE	A1011-1N	A1011-1N	A28F	R61Q	A34S	AS24
1022	1022	1145	1145	A1011-20N	A1011-20N	A28G	AS1	A35AK	AS20
102AM	102AM	1145A	1145A	A1011-21N	A1011-21N	A28K	AS5	A35AL	AS16
1036	1036	1145CE	1145CE	A1011-22N	A1011-22N	A28L	AS7	A35AM	AS56
1036G	1036G	1145E	1145E	A1011-23N	A1011-23N	A28M	AS3	A35AS	AS64
103AM	103AM	1145EF	1145EF	A1011-24N	A1011-24N	A28N	61W	A35BK	AS38
1041C	1041C	1145F	1145F	A1011-25N	A1011-25N	A28P	R61W	A35BL	AS46
1041E	1041E	1145FG	1145FG	A1011-26N	A1011-26N	A28R	AS25	A35BM	AS40
1041G	1041G	1145G	1145G	A1011-27N	A1011-27N	A28S	AS23	A35BS	AS66
1041GA	1041 GA	1145H	1145H	A1011-2N	A1011-2N	A29AK	AS19	A35DK	AS30
1041GB	1041 GB	1145J	1145J	AI 011-3N	AI 011-3N	A29AL	AS15	A35DL	AS50
1041GR	1041 GR	1145K	1145K	A1011-4N	A1011-4N	A29AM	AS55	A35DM	AS52
1041H	1041H	11451	11451	A1011-5N	A1011-5N	A29AS	AS63	A35DS	AS58
1041K	1041K	1176	1176	A1011-6N	A1011-6N	A29BK	AS37	A35EK	AS18
1041N	1041N	1179	1179	A1011-7N	A1011-7N	A29BL	AS45	A35EL	AS14
1041W	1041W	1179A	1179A	A1011-8N	A1011-8N	A29BM	AS39	A35EM	AS22
1041Y	1041Y	1307A	1307A	A1011-9N	A1011-9N	A29BS	AS65	A35ES	AS62
1043J	1043J	1307W	1307W	A1011D1	A1011D2	A29D	AS71	A35FK	AS36
1046	1046	1430	1430	A1011D12	A1011D12	A29DK	AS29	A35FL	AS44
1046A	1046A	1502M	1502M	A1011D2	A1011D2	A29DL	AS49	A35FM	AS70
104AM	104AM	1512O	1512	A1011D3	A1011D3	A29DM	AS51	A35FS	AS68
1054	1054	1536	1536	A1011D34	A1011D34	A29DS	AS57	A35GK	AS28
1054FN	1054FN	1536R	1536R	A1011D4	A1011D4	A29EK	AS17	A35GL	AS48
1054LB	1054LB	1539	1539	A1011D41	A1011D41	A29EL	AS13	A35GM	AS54
1054MT	1054MT	1540	1540	A1011P	A1011P	A29EM	AS21	A35GS	AS60
1054TW	1054TW	1559	1559	A1011PZ	A1011PZ	A29ES	AS61	A35H	AS74
1054UN	1054UN	1560	1560	A1011PZRA	A1011PZR	A29FK	AS35	A35NN	AS84
1054WC	1054WC	1597	1597	A1054WC	A1054WC	A29FL	AS43	A35T	AS10
1054WD	1054WD	1598	1598	A1054WD	A1054WD	A29FM	AS69	A35U	AS76
1069	1069	1599	1599	A1114A	A1114A	A29FS	AS67	A35V	AS12
1069H	1069H	1600	1600	A1114B	A1114B	A29GK	AS27	A35W	AS78
1069HN	1069HN	1793V	1793V	A1114C	A1114C	A29GL	AS47	A35X	AS32
1069LB	1069LB	1794V	1794V	A1114D	A1114D	A29GM	AS53	A35Z	AS34
1069N	1069N	1CH	52B	A1114DD	A1114DD	A29GS	AS59	A37DD	AS80
1071	1071	25	25	A1114E	A1114E	A29H	AS73	A37HH	AS82
1079B	1079B	2CH	53B	A1114F	A1114F	A29T	AS9	ABA11	SF11
1092	1092	999N	999N	A1114FM	A1114FM	A29U	AS75	ABC1	UCM1
1092-6000	1092-6000	999N	Y1E	A1114G	A1114G	A29V	ASII	ABS10	AB62A
1092-7000	1092-7000	A1001AH	A1001AH	A1114H	A1114H	A29W	AS77	ABS11	AB19
1092B	10928	A1001BH	A1001BH	A1114J	A1114J	A29X	AS31	ABS11L	AB20
1092D	1092D	A1001C1	A1001C1	A1114K	A1114K	A29Z	AS33	ABS12	AB18
1092DS	1092DS	A1001C2	A1001C2	A1114L	A1114L	A31DD	AS79	ABS12L	AB21
1092H	1092H	A1001D1	A1001D1	A1114M	A1114M	A31HH	AS81	ABS14	AB14
1092J	1092J	A1001D2	A1001D2	A1114Q	A1114Q	A34A	A61T	ABS14L	AB12

CROSS REFERENCE





CROSS REFERENCE

ORION

ABS14L
ABS18
ABS18L
ABS19
ABS19L
ABS20
ABS24
ABS26
ABS4
ABS5L
ABS5L
ABS6L
ABS6L
ABS7
ADI10
AD11
AD12
AD13
AD13AP
AD13BP
AD13P
AD13P
AD13P
AD14L
AD15
AD15AP
AD15BP
AD15CP
AD15CP
AD15P
AD15P
AD33
AD33
ADS11
AGE10
AGE12
AGE13L
AGU11L
AGU12
AGU12L
AGU13
AGU13L
AGU14
AGU14L
AKS1
AKS1L
AKS2
AM10
AM10L
AM11
AN10
AN2
AN3
AN5
AN8

ILCO

AB13
CS91C
CS91CR
CS91E
CS91ER
AB17
191AB
AB23
191AB
AB10
AB16
AB11
AB15
AB9
PA5
WT5
PA6
PA8
PA8P
PA8P
73VBP
PA8P
X88
PA6
V35
V35P
V35P
V35
V35P
V35P
V37P
PA8
X88
ALP7
AG5
AG1
AG4
AG2
AGI1R
AG1
AU3
AU4
AUI
AU2
63VS
R63VS
AD1
AA3
LF13
DM20
SP6
SF9
SP7
SP8
SF9

ORION

ANK10
ANK11
ANK12
ANK13
ANK14
ANK15
ANT10
APH1
APH10
APH11
APH1L
APH2L
APH4L
APH5L
AR1A
AR3A
AR5A
ARW11
ARW12
ARW12
ARW12
AS4
AS6
ASA1
ASA111
ASA111L
ASA11L
ASA11L
ASA12
ASA13
ASA15
ASA2
ASA20
ASA3
ASA5
ASA5P
ASL1
AT1L
AT10
AT2L
AZB11
AZB11L
AZB12
AZB12L
B62P1
B62Pi0
B62P11
B62P12
B62P13
B62P14
B62P15
B62P2
B62P3
B62P4
B62P5
B62P6
B62P7
B62P8
B62P9

ILCO

AK1
AK2
AK3
AK6
AK4
AN2
H61V
C171
ALP4
ALP5
C171R
A190
ALP3
ALP2
AL6
AL7
AL8
755U
1025AR
1025B
10258
SF7AF
SF8
AS90
V61A
SR61W
AS41
SB11
SB7
SB8
SB6
AS89
61X
AS86
SB10
SB11
AUS1
AT2
AT1
AT3
AZ2R
AZ2
999
9998
B62P1
B62Pi10
B62P11
B62P12
B62P13
B62P14
B62P15
B62P2
B62P3
B62P4
B62P5
B62P6
B62P7
B62P8
B62P9

ORION

B80
B80
B80P
B82
B82
B82P
B82P10
B82P11
B82P12
B82P13
B82P14
B82P15
B82P2
B82P3
B82P4
B82P5
B82P6
B82P7
B82P8
B82P9
B83
B83
B83P
B84
B84
B84P
B85
B86
B86
B86P
BAL20
BAL40
BD10
BD20
BD30
BDA1A
BDA1B
BDA1C
BDA2A
BDA2B
BDA2C
BDA2D
BDA3A
BDA3B
BDA3C
BDA3D
BDA4A
BDA4B
BDA4C
BDA5A
BDA5B
BEL10
BEL11
BEL12
BEL13
BEL14
BKS10
BKS10L

ILCO

B80
X225
B80P
B82
P1102
B82P
B82P10
B82P11
B82P12
B82P13
B82P14
B82P15
B82P2
B82P3
B82P4
B82P5
B82P6
B82P7
B82P8
B82P9
B83
B83
B83P
B85
P1101
B84P
S1105
B86
P1106
B86P
BA1
BA2
C219
C216
C218
BD1A
BD1B
BD1C
BD2A
BD2B
BD2C
BD2D
BD3A
BD3B
BD3C
BD3D
BD4A
BD4B
BD4C
BD5A
BD5B
BEL3
BEL4
BEL5
BEL6
BEL7
DA3
KS91C
X999R

ORION

BKS12
BKS13
BKS14
BKS15
BKS16
BKS17
BKS18
BKS19
BKS20
BKS21
BKS22
BKS23
BKS24
BKS25
BKS26
BKS27
BKS28
BKS29
BKS30
BKS31
BKS32
BKS33
BKS34
BKS35
BKS36
BKS2
BKS3
BKS4
BKS5
BKS6
BKS7
BKS8
BKS9
BKS32
BKS33
BKS34
BKS35
BKS36
BKS37
BKS38
BKS39
BKS40
BKS41
BKS42
BKS43
BKS44
BKS45
BKS46
BL10
BL10L
BLK10
BLK10L
BLS11
BLS12
BMR10
BMR10
BMR12
BMR13
BMR14
BMR14L
BO1
BO10
BO10P
BO11
B012
B013
B014
B015
B020
BRG10L
BRG11
BRG11L

ILCO

BKS25
BKS26
BKS27
BKS28
BKS29
BKS30
BKS31
BKS32
BKS33
BKS34
BKS35
BKS36
BKS2
BKS3
BKS4
BKS5
BKS6
BKS7
BKS8
BKS9
BKS10
BKS11
BKS12
BKS13
BKS14
BKS15
BKS16
BKS17
BKS18
BKS19
BKS20
BKS21
BKS22
BKS23
BKS24
BKS25
BKS26
BKS27
BKS28
BKS29
BKS30
BKS31
BKS32
BKS33
BKS34
BKS35
BKS36
BKS2
BKS3
BKS4
BKS5
BKS6
BKS7
BKS8
BKS9
BKS10
BKS11
BKS12
BKS13
BKS14
BKS15
BKS16
BKS17
BKS18
BKS19
BKS20
BKS21
BKS22
BKS23
BKS24
BL10
BL10L
BLK10
BLK10L
BLS11
BLS12
BMR10
BMR10
BMR12
BMR13
BMR14
BO1
BO10
BO10P
BO11
B012
B013
B014
B015
B020
BRG10L
BRG11
BRG11L

ORION

BRG12
BRG12L
BRG14
BRG17
BRG20
BRG20
BRG26
BRG27L
BRG7
BRG8
BRU5
BSIO10L
BS11
BS12
BS12
BS12L
BS13
BS14
BS15
BS15L
BS16L
BS21
BS20
BT10
BT11
BTA4
BTA4L
BTA5
BTA5L
BU10
BU10
BU10L
BU10L
BU11
BU11
BU11L
BU17
BVA10
BVA10L
BW10
BW10
BW11
BW12
BW13
BW14
BW14P
BW15
BW15FP
BW15P
BW16
C1096CN
C1096LN
CE10L
CE110
CE11L
CE110
CE12L
CE120
CE130

ILCO

BUR11
BUR12
BUR6
BUR9
BUR1
BUR14
BUR13
BUR1
BUR4
BUR5
BR1
1098DB
1098M
H1098LA
O1098LA
O1098LA
X1199B
X1199G
O1122A
O1122AR
125C
PN2
BAS1
1970AM
S1970AM
BT1
BT3
BT2
BT4
BU2
MWI
BUI
MW2
BU8
X132
BU7
BU3
BV1
BV2
63Vp
HF20
NE8
WT3
KL4
BMW1
BMW1
BMW2
BMW3P
BMW2P
HF40
C1096CN
C1096LN
CS13
CS32
CS11
CS10
CS25
CS26
CS43





ORION	ILCO	ORION	ILCO	ORION	ILCO	ORION	ILCO	ORION	ILCO
CE14	62CS	CS150	CA4	CY220	CH4	DA32	DA32		
CE14	ST91A	CS160	CA3	CY220	CU8	DA32	X227		
CE14L	R62US	CSA18	CS91FR	CY23L	CH5	DA32P	DA32P		
CE15L	LR62US	CSA18L	CS91F	CY23L	CU9	DA33	DA33	ORION	ILCO
CE150	L62US	CSA19	AB62G	CY23O	CH6	DA33	X228	DO161	G190B
CE160	CS29	CSA19L	AB62GR	CY23O	CU10	DA34	DA34	DO165	DM65-11
CE180	CS28	CSA20	9CX	CY24L	1040U	DA34	X237	DO168	G195A
CE190	CS1	CSA22	WA91S	CY24L	CH7	DA34P	DA34P	DO171	G197A
CE20LO	CS13	CSA33	AB17	CY24O	CU12	DA35	DA35	DO172	G190A
CE200	CS12	CSA4	NS9CS	CY25	CH8	DA35	X238	DO174	G192A
CE21	CS14	CSA4L	CS91B	D998GA	D998GA	DA37	DA37	DO175	G196A
CE21L	CS15	CSA4L	NSR9CS	DA10	MZ12	DA37	X242	DO18	DM11
CE22	CS44	CSA4P	CS91CR	DA10BP	MZ12	DA37P	DA37P	DO180	G200
CE23	BD6	CSA4PL	CS91C	DA10P	MZ12	DAD10	D1V	DO19	DO4F
CE24	CS46	CSA5	9CS	DA11	62DT	DAD11	D1V	DO19	H64E
CE25	CS47	CSA50	CS91	DA11BP	62DT	DAD12	D1K	DO195	G194A
CE26	CS48	CSA51	AB17	DA11L	62DU	DAD13	D1A	DO197	G191A
CE270	CS49	CSA5L	R9CS	DA11LP	62DU	DAM10L	DA2	DO198	G193A
CE280	CS50	CSA5P	AB62E	DA11LP	DA24	DAV10	DAV10	DO201	G190E
CE29	CS51	CSA5P	CS91E	DA11P	62DT	DF11	CA2	DO21	D64
CE300	CS52	CSA5PL	AB62ER	DA12	62DV	DO100	DM57	DO215	DM110
CE310	CS53	CSA5PL	CS91ER	DA12LBP	SJ1	DO101	G191	DO22	DM58
CE32	CS54	CSN10	C1054B	DA13	DT4	DO102	G193	DO227	G190MA
CE330	CS55	CV10	CA91	DA13L	DT6	DO103	G194	DO229	DM62
CE340	CS56	CV11	CA91A	DA14	DT8	DO104	G196	DO23	DM60
CE350	CS57	CV12	CA91B	DA14L	DT7	DO105	G197	DO23L	DM63
CE360	CS58	CV13	CA91C	DA15	DT5	DO106	G199	DO24	ID1
CE37	CS59	CV13	ZE91G	DA15L	DT1	DO107	G190	DO25	DM3
CE38	SH91K	CV14	CA91L	DA16	D72Z	DO10L	DM32	DO29	DM29
CE6O	CS45	CV14	ZE91CR	DA16	DT14	DO11L	DO1S	DO29L	DM30
CEM9	NE49	CV14L	ZE1	DA16L	D72D	DO11O	DO1SR	DO30	DM61
CF5	CF1	CV14L	ZE91C	DA18	DA23	DO121	G200	DO31	G198
CF6	CF2	CV15	ZC4	DA18BP	DA23P	DO12L	DM27	DO44	DM25
CH6O	1516	CV16	ZC3	DA18L	DA24	DO12O	DM10	DO45	HU4
CHG15	752	CV17	ZC2	DA18LP	DA24	DO13L	64D	DO49	DM8
CHG16L	1042Z	CV18	ZC1	DA18NP	DA23P	DO13O	64RD	DO5	DM25
CLM12	1040A	CV19	CA91D	DA18P	DA23-P	DO14	DO3M	DO69L	DM26
CLM13	R1040C	CV21	AR62K	DA19	62DT	DO140	DM33	DO71	DM22
CLM14	1040C	CV22	UR62K	DA21	DT20	DO140L	DM43	DO73	DM61
CLM15	R1040E	CVL10	CVL1R	DA22	DA25	DO141	DM34	DO79	G192
CLM16	1040E	CVL10L	CVL1	DA22	X123	DO141L	DM44	DO8	DM2
CNA2	CNA2	CY100	1767CH	DA22P	DA25P	DO142	DM35	DO84L	DM23
CNT10	CE1	CY100	D1707K	DA23	DA25	DO142L	DM45	DO86	G195
CNT10L	R62CA	CY110	D1759L	DA23BP	DA25P	DO143	DM36	DO9	FT6
CNT11	CTI	CY110	S177DP	DA23L	B54	DO143L	DM46	DO93	DM7
CNT12	CT2	CY120	1701G	DA23LBP	B54	DO144	DM37	DO94	DM6
CRB11	CB12	CY130	1769CH	DA23P	DA25-P	DO144L	DM47	DO9L	FT6R
CRB12	1001DH	CY140	S1768CH	DA24	DA28	DO145	DM38	DO9LAP	FT6R
CRB28	BC1	CY15	L1098C	DA24P	DA28	DO145L	DM48	DO9LP	FT6R
CRB28	CB7	CY17	U1770CH	DA25	INF90	DO146	DM39	DON10L	S54F
CRB29	1001GH	CY18O	1768CH	DA25P	INF90	DO146L	DM49	DON11	DO1
CRB31	CB10	CY190	P1770U	DA29	DA28	DO147	DM40	DPT10L	PL1
CRB43	1001A2	CY190	Y152	DA29P	DA28	DO147L	DM50	DPT11	DL2
CRB44	CB9	CY1O	P1786	DA30	DA30	DO148	DM41	DPT12	LAP2
CRB46L	LH10	CY1P	P1786P	DA30	X197	DO148L	DM51	DT13L	TR40
CRB4P	CB1	CY20O	S1770U	DA30P	DA30P	DO149	DM42	DT13LP	TR40
CRB5	CB3	CY21	P1170U	DA31	DA31	DO149L	DM52	DUB10	P65A
CRB5P	CB2	CY22L	CH3	DA31	X210	DO158	G190C	DUB10L	P65C
CRN10	CN1	CY22L	CU7	DA31P	DA31P	DO16	DM21	DUB11	p65C

CROSS REFERENCE



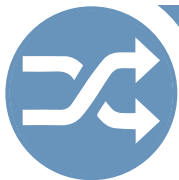

ORION

DUB11L
DUB12
DUB12
DUB12L
DUB13
DUB13
DUB13L
DUB13L
DXT5
DXT5B1
DXT5B2
DXT5B3
DXT5C1
DXT5C2
DXT5C3
DXT5CM
DXT5D1
DXT5D2
DXT5D3
DXT5DM
DXT5GM
DXT6
DXT6B1
DXT6B2
DXT6B3
DXT6BM
DXT6C1
DXT6C2
DXT6C3
DXT6CM
DXT6D1
DXT6D2
DXT6D3
DXT6DM
DXT6GM
EFCK
EFCK
EFDA
EFDA
EFDB
EFDB
EFDK
EFDK
EFDM
EFDM
EGO12L
ELZ10
ERA10
ESA10
ESA10L
ETS10
ETS11
ETS2
EVA1
EVA14

ILCO

P65C
HR62BZ
R62BZ
PA91F
HR64K
PA91H
H64K
PA91K
D1054K
DXB10
DXB20
DXB30
DXC10
DXC20
DXC30
54CM
DXD10
DXD20
DXD30
54DM
54GM
D1054KA
DXB10
DXB2
DXB3
DXB4
DXC10
DXC2
DXC3
DXC4
DXD1
DXD2
DXD3
DXD4
DXG5
C185CK
EC10
C185DA
EC12
C185DB
EC14
C185DK
EC16
C185DM
EC18
EEI
ELZ1
ER5
ES1
ES1R
ET9
62C
ET8
EV4
EV2

ORION

EVA2
EVA3
EVA4
EVA5
EVA6
EVA8
EZC10L
F1122A
F1122AR
FA1A
FA1B
FA1C
FA1D
FA1D
FA1L
FA1O
FA1P
FA21
FA21UP
FA2A
FA2B
FA2D
FA2O
FA2S
FA2S
FA3
FA4
FA6O
FA8
FAA10
FAA10
FAA11
FAA11
FAA15L
FAAO
FAAO
FAB14
FABO
FABO
FA BO
FAC
FAD
FAD
FAE
FAF
FAG
FAG2
FAG2BP
FAG2P
FAG2YP
FAG2YP
FAG3
FAH
FAK
FAK
FAKAP
FAKBP
FAKGP
FAS10

ILCO

EVA1
EVA1R
62EV
R62EV
EV5
EV7
ES1
F1122A
F1122AR
LR61D
AB2B
H61G
B61GA
SP5
SF10
FT37
FT37
NE58
NE58
YR62
R61H
61G
F91C2
R61G
R61GA
FT38
F91C
F91CR
F91C8
65CB
SK91A
65CD
SK91D
65CE
R61D
SP1
X99
61D
R63TS
SP2
SP3
R61TS
SP4
R63SP
63SP
F91G
NE54
NE54
YU2
YU2
X167
YU2
NE55
F91H
FT46
NE59
FT46
X152P
NE54
FAS1

ORION

FAS10L
FAX
FAY
FAYP
FD10
FD11
FD12
FD12AP
FD12P
FD13
FD14
FD15
FD16
FD17
FD17L
FD18
FD181
FD19
FD19
FD191
FD19L
FD1O
FD1P
FD2
FD20
FD20L
FD21
FD22
FD23
FD24
FD24
FD25
FD26
FD27
FD28
FD31
FD31L
FD31P
FD32
FD34
FD34
FD35P
FD36
FD36
FD36P
FD38L
FD38LAP
FD38LP
FD42
FD42CP
FD4P
FD5
FD5P
FD6P
FD7
FD7P
FD7P
FD8
FD9

ILCO

ST1
F43
NE56
NE56
FC2
CE6
FC7
FC7-P
FC7-P
FC9
FC8
62KT
KL2
H62FD
HR62FD
HF22
HF23
FT10
YM14
FT10R
YM15
WB3
WB3
WB2
YS2
YS1
1127D
1127DP
1127ES
1167FD
H51
BR20
FC7
FF1
S1181FD
P1127C
S1167C
P1127C
1190LN
H63
X207
1188LNP
1191ET
H62
H62P
H59
X202
H59P
1195FD
H71P
S1186TSP
1185FD
1185TP
S1185TP
1184FD
1186TSP
H54
1127DU
S1170LN

ORION

FD9L
FD9L
FEB5
FEB5L
FI1O
F14CP
FL20
FLO5
FLO5L
MR10
FTH10
FTH11
FTH12
FTH14
FTH16
GBN10
GBN10L
GBN11
GBN12
GBN13
GBT10
GE10
GE10
GE10L
GE11
GE12L
GE13L
GE180
GE37L
GH10
GH2
GH3
GIB110
GIP10
GLB13
GLB15
GLB19L
GLB22
GM10P
GM12L
GM12L
GM12LP
GM13P
GM14L
GM14LP
GM150
GM15PO
GM16L
GM16L
GM16LP
GM20
GM40
GM50
GM50
GM5P
GM7L
GM8L
GM90
GMA

ILCO

H50
S1167FD
CF1
CF2
NE57
GT15RAP
Z4
FL91
R67F
C172F
FTH3
FTH4
FT1
FTH5
FTH6
ZE91G
R62K
GA91
GA1
GAS91
LN4
GE5
GE8
GE3R
7GE
LR7GE
GE6
GE15
GE4
GH2
GH1
GH3
1033G
GIP91
GB2
GB4
GB1
GB3
B53
B72P
X192
B72P
DC3
B74
B74P
P1099
B68P
P1100
P1108
B76P
H1098LA
1098DB
B53
X143
B53
B56
869
X184
B48

ORION

GMA
GMAP
GMAV
GMAV
GMAVP
GMB
GMB
GMBP
GMC
GMC
GMC
GMC
GMCV
GMCVP
GMCW
GMCW
GMD
GMD
GMDP
GMDP
GMDW
GME
GME
GMEP
GMEV
GMEVP
GMEW
GMEWP
GMH
GMH
GMHP
GMHW
GMJ
GMJ
GMK
GMK
GMR
GMRP
GMS
GMV
GOL10L
GOL11L
GRQ1
GRQ10
GRQ10L
GRQ12
GRQ13
GRQ14
GRQ15
GRQ15L
GRQ16
GRQ17
GRQ17L
GRQ18
GRQ18L
GRQ1L
GSN12L
GUA50
H1054F
H1098DB

ILCO

P1098A
GMAP
B62
P1098AV
P1098AV
B49
S1098B
GMBP
GMBP
B50
P1098CV
GMCP
P1098CV
B63P
P1098WC
B64P
B51
S1098D
B51P
GMDP
S1098WD
B44p
P1098E
B44P
P1098EV
B77P
P1098WE
B78P
B45
S1098H
B45P
S1098WH
B46
P1098J
B47
S1098K
B55
B55
L98AS
LP98A
GL3
GL1
GU4
S65G
RS65G
GU91F
GU91G
65L
GU91B
GU3
RC1
LR65G
L65G
LR65Y
L65Y
GU4R
D1098B
191A
H1054F
H1098DB





ORION	ILCO	ORION	ILCO	ORION	ILCO	ORION	ILCO	ORION	ILCO
H1098M	H1098M	HF14	62PD	HF47	HF13	HO21	HD70		
H1098X	H1098X	HF14	HR62PD	HF47L	HF12	HO21P	HD70		
H1122M	H1122M	HF14L	H62PD	HF52P	HF52P	HO22	HD71		
H65	H65	HF14L	R62PD	HF54	B61	HO22P	HD71	ORION	ILCO
H65	X221	HF15	H62VP	HF54	X168	HO23	HD23	HO88P	HD91P
H65P	H65P	HF15	U62VP	HF54P	B61	HO24	HD33	HO89	HD89
H66	1193MU	HF15L	UR62VP	HF55P	HF55P	HO25	HD35	HO89AP	HD89
H66	H66	HF16	HF10	HF56	BMW3	HO26	HD34	HO90	HD90
H66P	H66P	HF16L	HF11	HF56P	BMW3P	HO27	HD32	HO90	X181
H67	1193FD	HF17	MB15	HF57P	HF52P	HO28	HD30	HO90P	HD90P
H67	H67	HF17P	MB15P	HF61L	B59	HO29	HD4	HO91	HD88
H67p	H67P	HF18	MB18	HF64P	S34YS-P	HO29L	HD18	HO91P	HD88P
H70	H70	HF18P	MB18P	HF65P	S58HF-P	HO30	HD20	HO92	HD92
H70	X231	HF19	HF21	HGI11	HG3	HO30L	HD19	HO92	X183
H70P	H70P	HF20	YM25	HO1	HD8	HO32	67LD	HO92P	HD92P
H75	1196FD	HF20L	YM27	HO10	HO61TR	HO34	HD31	HO93	HD93
H75	H75	HF21	HF47	HO100	HD100	HO35	HD29	HO93	X189
H75P	H75P	HF21	HF50	HO100	X205	HO36	67J	HO93P	HD93P
H998	H998	HF21L	HF49	HO100P	HD100P	HO36L	HD24	HO94	HD94
H998GA	H998GA	HF22	HF37	HO101	HD101	HO37	67K	HO94	X190
H998GB	H998GB	HF23	HF41	HO101P	HD101P	HO37L	HO61S	HO94AP	HD86
H998GC	H998GC	HF24	AU15	HO102P	HD102P	HO37L	R67K	HO94AP	HD94
H998GD	H998GD	HF25	OP44	HO103	HD103	HO50	HD10	HO95	HD95
H998GE	H998GE	HF26	MB18	HO103	X214	HO50L	HD12	HO95	X191
H998GF	H998GF	HF26P	MB18-P	HO103P	HD103P	HO51	HD14	HO95AP	HD89
H998GG	H998GG	HF27	HF43	HO104	HD104	HO51L	HD11	HO95AP	HD95
H998GH	H998GH	HF28	MB41	HO104	X215	HO52	HD15	HO96	HD96
H998GK	H998GK	HF28P	MB41P	HO10L	HO61T	HO52	HD61	HO96	X193
H998R	H998R	HF29	MB38	HO11	HD14	HO52L	H76G	HO96P	HD96P
H998VA	H998VA	HF29P	MB38	HO11	HD5R	HO52L	HD60	HO97	HD97
H998VB	H998VB	HF30	HF46	HO11L	HD5	HO53	HD68	HO97	X194
H998VC	H998VC	HF31	R63Y	HO12	HD13	HO53L	HD65	HO97P	HD97P
H998VD	H998VD	HF32	OP42	HO12	HD61	HO54	HD67	HO98	HD98
H998VE	H998VE	4HF33L	S62DW	HO12L	67LB	HO54L	HD66	HO98	X195
H998VF	H998VF	HF35	R62VB	HO12L	H76G	HO55	HD83	HO98P	HD98P
H998VG	H998VG	HF35L	61VW	HO12L	HD60	HO55P	HD83P	HO99	HD99
H998VH	H998VH	HF35L	62VB	HO13	HD7	HO56	HD82	HO99	X204
H998VK	H998VK	HF35L	62VW	HO14	HD45	HO56L	X130	HO99P	HD99P
H998YA	H998YA	HF35L	L62VB	HO14L	HO44	HO56LP	X130	HOR11	HS1
H998YB	H998YB	HF36	OP60H	HO15	HD72	HO56P	HD82P	HRD1	X101
H998YC	H998YC	HF36L	R62PE	HO15L	HD73	HO58	HD74	HRD10L	HYD12
H998YO	H998YO	HF37	R62VN	HO15LP	HD73	HO58	X84	HRD10L	X226
H998YE	H998YE	HF38	HF15	HO15LP	HO41	HO58L	HD58	HRD13L	HYD13
H998YF	H998YF	HF38	HF4	HO15P	HD40	HO58LP	HD58	HRD13L	X234
H998YG	H998YG	HF38L	HF7	HO15P	HD72	HO58LP	HD75	HRD1L	X102
H998YH	H998YH	HF39	63W	HO17	HD49	HO58P	HD63	HRD2L	HYD5
H998YK	H998YK	HF39L	R63W	HO2	HD59	HO58P	HD69	HRD3	X100
H998YMK	H998YMK	HF40	HF6	HO20	HD75	HO58P	HD74	HR03L	X93
HA10	BU4	HF40	HF9	HO20	X138	HO60	HD85	HRD4	X126
HA10L	BU4R	HF40	R63K	HO20BP	HD75	HO60	HD86	HRD4L	X127
HD12L	1003M	HF40L	HF16	HO20HP	HD58	HO60AP	HD85	HRD5	X96
HED10	HN2	HF40L	HF5	HO20HP	HD75	HO60AP	HD86	HRD5L	HY6R
HED11	HN1	HF41	62VG	HO20L	HD63	HO60P	HD85	HRD6	X97
HF10	A62VN	HF42	OP60C	HO20LBP	HD63	HO60P	HD86	HRD6L	X98
HF11	G1	HF43	G63Y	HO20LHP	HD63	HO64FP	X265	HRD7	X95
HF11L	R62VA	HF44	62WB	HO20LHP	HD74	HO71	HD70U	HRD7L	X94
HF12	L62VA	HF45	R62WA	HO20LP	HD63	HO71P	HD70UP	HRD8L	HD51
HF12L	LR62VA	HF45L	AUDS2	HO20P	HD58	HO88	HD91	HRD9	HY9
HF13	63Y	HF47	62PE	HO20P	HD75	HO88	X182	HTV10	VA2

CROSS REFERENCE





ORION	ILCO	ILCO	ORION	ILCO	ORION	ILCO	ORION	ILCO
JUW9		JU5	KF8L	PA91	LCW29	LK13	LMP11	RT19
JWL10		R62X	KF9	64R	LCW30	GR9	LMP12	SM10
JWL10L		62X	KF9L	RK4	LCW32	1004	LMP13	NE47
JWL13L	JO91C	KFV10	KFV10	KFV1	LCW32L	1004R	LMP14	NE45
JWL15	JU2	KI1L	KI1L	KK1	LCW35L	LK21	LPI100	63L
K1054B	K1054B	KI1L	KI1L	X233	LEG10	62LG	LP13L	63
K1122D	K1122D	K1ILAP	K1ILAP	KK1P	LF11O	LF1	LP13L	63L
KA10	KA2	KI4L	KI4L	X240	LF11Q	LF1	LPL10	LE1
KA10L	KA1	K15LAP	K15LAP	KK3-P	LF12O	LF7	LPS10	LP24
KA12	YH25	KVR11	KVR11	KVR91	LF14LQ	LF1	LPS10L	LP25
KA12L	YH26	L1001AH	L1001AH	L1001AH	LF15	HR62DG	LPS11	LP39
KA13	KA5	L1001EH	L1001EH	L1001EH	LF15	LR62DG	LPS1L	LP28S
KA14	X41	L1001GRML	L1001GRM	L1001GRM	LF16O	LF4	LPS12	LP1R
KA14L	X34	L1003AB	L1003AB	L1003AB	LF16P	BR19	LPS12L	LP1
KA15	KA12	L1010N	L1010N	L1010N	LF16P	LF4	LPS13	LP23
KA16	KA14	L1054B	L1054B	L1054B	LF17O	LF17	LPS13L	LP29
KA17	KA15	L1054G	L1054G	L1054G	LF17O	X157	LPS14	R62QB
KA17L	KA11	L1054WB	L1054WB	L1054WB	LF17P	LF17	LPS14L	LP28
KA19	KA13	LA11	LA11	GT3	LF18	L62FD	LPS15	LP27
KA1L	KA11	LA11L	LA11L	GT4	LF20O	WB1	LPS15L	LP6
KA1O	KA15	LA12	LA12	GT1	LF20P	WB1	LPS16	LP7
KA2P	KA14	LA12L	LA12L	GT2	LF21	LF14	LPS16L	LP7R
KA3P	KA14	LAD3LP	LAD3LP	LA-2P	LF23	LF6	LPS17	LP21
KA4CP	KW14P	LAS1	LAS1	L6S	LF24O	62FG	LPS17L	LP21R
KA4L	KW14R	LAS11	LAS11	KM4	LF24O	CE3	LPS20L	LP5
KA6L	KA6	LAS14	LAS14	L4A1	LF25L	LF16	LPS21L	LP2
KA6L	X23	LAS2	LAS2	L6FM	LF26O	LF10	LPS21L	LPBS
KA6O	KA7	LAS20	LAS20	KM8	LF27O	LF24	LPS22L	LPD2
KA6O	X24	LAS20L	LAS20L	KM9	LF2L	C209R	LPS23	LP32R
KB10	63VN	LAS3	LAS3	L5CR	LF2O	C209	LPS23L	LP32
KB10B	VW63	LAS3L	LAS3L	L5RC	LF31	LF23	LPS24	LP31R
KB11	VW63	LAS6	LAS6	PN3	LF32O	LF19	LPS24L	LP31
KCDA22	DA25	LAS8	LAS8	L4RM	LF38L	LF8	LPS25	LP30
KF10	PJM	LC10L	LC10L	LC2	LF39L	LF18	LPS25L	LP30R
KF11	SM3	LC10O	LC10O	LC1	LF3O	LF20	LPS29L	LP26S
KF11L	SM4	LC11O	LC11O	S1096G	LF40L	LF25	LPS42L	LP2
KF12	NR63G	LC12L	LC12L	LC5R	LF44L	LF25	LPS44L	LP26
KF12L	N63G	LC12O	LC12O	S1096F	LF53O	C209L	LXP90P	LXP90P
KF13	KM5	LC13O	LC13O	LC4	LF6O	LF9	LXV90P	LXV90P
KF13L	KM7	LC14	LC14	LC3	LG10	LS10	M64	M64
KF14	L3TX	LC15O	LC15O	S1096D	LG11	LS11	MA10	MZ4
KF15	L3XY	LCW10L	LCW10L	1004R	LG17	LS17	MA10	X4
KF18	KM2	LCW12	LCW12	24	LG18	LS18	MA10AP	MZ3
KF20	63H	LCW13	LCW13	4	LG19	LS19	MA10AP	MZ4
KF20	PJH	LCW13L	LCW13L	4R	LG22	LS22	MA10L	MZ5
KF20L	R63R	LCW14	LCW14	LK1	LG23	LS23	MA10L	MZ8
KF21	KM6	LCW14L	LCW14L	LK2	LG28	LS28	MA10L	X5
KF22	L1TL	LCW15L	LCW15L	24B	LG29	LS29	MA10LAP	MZ2
KF23	L1S	LCW16	LCW16	24CL	LG32	LS32	MA10LAP	MZ5
KF23L	L1T	LCW17	LCW17	LK5	LG33	LS33	MA10LP	MZ8
KF24	L2EX	LCW18	LCW18	LK8	LG34	LS34	MA10P	MZ7
KF30	KM3	LCW19	LCW19	LK7	LG35	LS35	MA11	MZ9
KF30	PJM	LCW20	LCW20	LK4	LIT10	LT3	MA11	X26
KF31	N63G	LCW21	LCW21	LK3	LIT11	LT1	MA11AP	MZ9P
KF31L	NR63G	LCW22	LCW22	LK6	LL10	RD4	MA11L	MZ10
KF32	KM2	LCW23	LCW23	24A	LM10	LM2	MA11L	X27
KF32	RC2	LCW24	LCW24	DL91	LM3L	LA13	MA11LAP	MZ10P
KF32L	KM10	LCW25	LCW25	RD1	LM3O	LA4	MA11LP	MZ10P
KF8	61PS	LCW26	LCW26	RD2	LMP10	LM1	MA11P	MZ9P





ORION	ILCO	ORION	ILCO	ORION	ILCO	ORION	ILCO	ORION	ILCO
MA12	MZ11	MPP14	R62BA	NN22	AA2	NN63BP	NE48		
MA13	MZ15	MPP5	PO1	NN22P	AA2	NN75P	RV4P		
MA14	MIZ14	MPP5L	PL2	NN23	NE31	NN81P	RN24		
MA15	X131	MRN12	ME2	NN23BP	BL11	NN9PP	RN30	ORION	ILCO
MA16	MZ13	MRN3P	ME6	NN23P	RE61XR	NS13	DT3	OLT10	ALP9
MA16	X131	MRN4P	ME1	NN24	NE18	NS13L	DT2	P1789	P1789
MA16AP	MZ13	MRN5P	ME3	NN24	NE27	NS17L	SR6	P1789	Y154
MA16AP	MZ13P	MRN9	ME7	NN24P	NE18	NU10	63VO	P1789P	P1789P
MA16L	MZ13R	MS10L	DC1	NN24P	NE27	NU11	HF26	P1793	P1793
MA16P	MZ13P	MS10LP	DC1P	NN25	Z3H	NU12	HF29	P1793P	Y155P
MA19	MZ13	MS11L	DC3	NN26H	NE34	NU13	HF18	P1794	P1794
MA19L	MZ13R	MS11LP	DC3P	NN126HAP	RN24	O1007CA	O1007CA	P1794P	Y157P
MA22AP	MZ16P	MS11P	TR33P	NN26HCP	RN24	O1007CB	O1007CB	P1795	P1795
MA23	MZ17	MS19L	FU2	NN26HDP	RN24-P	O1007CE	O1007CE	P1795	Y159
MA23AP	MZ17	MS3O	MIT3	NN26HP	RN24P	O1007LA	O1007LA	P1795P	Y159P
MA23DP	MZ19P	MS3O	X224	NN26HSP	RN24P	O1007LB	O1007LB	P54F	P54F
MA23FP	MAZ13EP	MS4	MIT2	NN26X	NE26	O1007LC	O1007LC	PA10	PZ1
MA23P	MZ17P	MS4	X213	NN27	NE20	O1007LD	O1007LD	PA11	PZ2
MA25	MZ22	MS5	MIT5	NN28	RE61F	O1007LDH	O1007LDH	PA12	PZ3
MA26	MZ20	MS5	X229	NN29	VO73S	O1007LDM	O1007LDM	PA13	PZ4
MA26	X199	MS8AP	MIT4P	NN3	NE36	O1007LE	O1007LE	PA15	PZ2
MA27	MZ16	MS8CP	MIT1	NN30	VO73	O1007LF	O1007LF	PB1005	FSP2
MA27	X178	MS8O	MIT1	NN30P	VO73	O1007LG	O1007LG	PB1021	621A
MA27AP	MAZ-6DP	MS8O	X176	NN31	NE40	O1007LH	O1007LH	PC5L	PL2
MA27AP	MZ16P	MS8P	MIT1P	NN33	Y61	O1007LHM	O1007LHM	PH11O	DM4
MA27P	MZ16P	MST10	1092	NN34	RT20	O1007LJ	O1007LJ	PH12	KP1
MA28	MZ25	MST3	MA3	NN35	NE30	O1007LK	O1007LK	PH12	PO4
MA28	X206	MTR10	MO1	NN36	NE41	O1007LL	O1007LL	PJ20	PJK
MA28P	MZ25P	N1007KMAN1007KMA		NN37	NE43	O1007LM	O1007LM	PJ21	PN1
MA30	MZ27	N1007KMBN1007KMB		NN39	NE42	O1007RA	O1007RA	PL10	OM10
MA30	X222	N1007RMAN1007RMA		NN4	63Q	O1007RB	O1007RB	PR10	AU4
MA30EP	MZ27P	N1007RMB		NN41	NE48	O1007RC	O1007RC	PR12	DK91E
MAC10	ME11		N1007RMB	NN41FP	NE48	O1007RD	O1007RD	PR12L	DK91C
MBL10	MB1	N1011P	N1011P	NN41P	NE48	O1007RDH		PR13	LR62VB
MCM10	MCM2	N1011S	N1011S	NN41QP	NE48		O1007RDH	PR13L	L62VB
MCM10L	MCM2R	N1069B	N1069B	NN43	H61N	O1007RDM		PR15	A63L
MCM11	MM2	N1179	N1179	NN44	BO3		O1007RDM	PRF11	PR91L
MCM12L	MCM1	N54G	N54G	NN44	BO6	O1007RE	O1007RE	PRF28F	PR91C
MD12	1518	NH3	1098GM	NN44	NE5	O1007RF	O1007RF	PRF3	S9P
MD3	A1515	NH3	1098M	NN45	RT7	O1007RG	O1007RG	PRF3L	SR9P
MD4O	1515	NLF10	NL2	NN46	63JA	O1007RH	O1007RH	PRF3PL	PR91S
MD8	1542	NLF10L	NF1	NN47	H61VO	O1007RHM		PRF4	PR91SA
MG4	MG91P	NN10	63M	NN48	H61VM		O1007RHM	PRF4	U9P
MG4L	MG91S	NN11	RE61XR	NN49	RT16	O1007RJ	O1007RJ	PRF4L	PR91NS
MG5	MG91C	NN11P	RE61XR	NN50	VL6	O1007RK	O1007RK	PRF4P	PR91
MME	F91EH	NN12	NE11	NN50P	VL6P	O1007RL	O1007RL	PRF4PL	PR91MS
MMF	F91FH	NN13	NE1	NN52	RN25	O1007RM	O1007RM	PRF4SF	PR91CS
MMH	F91HH	NN14	H63M	NN52DP	NE36	O1014S	O1014S	PRF5	PR91A
MNT4	MG91P	NN15	SR61N	NN52DP	RN25	O1122B	O1122B	PRF5L	PR91N
MNT4L	MG91S	NN16	MB59	NN56	RN31	O1122BE	O1122BE	PRF5P	SIC1
MNT4P	MG91	NN17	NE2	NN57	RN30	O1122BER		PRF5PL	PR91M
MNT4PL	MG91R	NN17	VO62	NN58	RN30		O1122BER	PRV1L	PR11
MNT5	MG91C	NN18	H61VR	NN58	X147	O1122BR	O1122BR	PU3	PU3
MNT5L	MG91N	NN18L	FTA2R	NN58AP	RN30	O1122C	O1122C	PW10	PO5
MON10L	MON1	NN19	NE22	NN58BP	RN30	OAL3P	OA91R	PW10P	PO5P
MPP10	61B	NN2	NE39	NN58P	RN30	OAL3PL	OA91	PW11	PO6
MPP11	B62B	NN20	V80P	NN60X	NE33	OAL4P	OA91P	PW11P	PO6
MPP12	R62B	NN20	VO6	NN62	VL8	OAL5L	OA91D	PW12	PO7
MPP13	62BA	NN21	NE13	NN62P	VL8P	OAL5P	OA91P	PW12P	PO7

CROSS REFERENCE



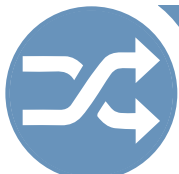

ORION

ILCO

R1000V R1000V
R1001EF R1001EF
R1001EG R1001EG
R1001EN R1001EN
R1003M R1003M
R1064E R1064E
REX10 RX2
REX11 RX1
RGL10 RG1
RM10 H1098NR
RN10 HV61
RN10L HVR61
RN11 7DC
RN11L R7DC
RN13 V61S
RN13L VR61S
RN14 H61P
RN14 SM6
RN14L HR61P
RN14L SM7
RN15 S61JD
RN16 61JD
RN16L R61JD
RN17 RN4R
RN17L RN4
RN18 62Z
RN18L R62Z
RN19 61P
RN19L R61 P
RN21 62UC
RN21L R62UC
RN22 61PE
RN22L RC2
RN23 L62UC
RN24 63P
RN25 NE15
RN26 NE17
RN27 62U
RN27L 62R
RN29 62RS
RN30 PJ1
RN31 PJ11
RN32 LN1
RN34 PJ2
RN34L PJ12
RN36 PJ3
RN36L PJ13
RN37 LN3
RN38 61PC
RN40 SMS8
RN41L RI5
RN53 RN27
RN58 RI6
RR10 62HB
RR11 62HA

ORION

ILCO

ORION

ILCO

ORION

ILCO

ORION

ILCO

RR12 62HC S58HFP S58HFP SP12P SP9 SWA11 SW1
RR13 62JB S60HFP S60HFP SP12UP F44 SWA12 SW3
RR14 62HE S66NNP S66NNP SP12UP NE23 SX1000F SX1000F
RR14 X28 S67NNP S67NNP SP24 IV1 SX1000FR SX1000FR
RR15 62HD S6BW S6BW SP24 X155 T19DA31 NSN11T2
RR16L 62HF S7BWP S7BWP SP24P IV1 T19FI1C GT10BT5
RR17L 62HG S8KBA KABI SP25AP SP25AP T19FI4A GT15RT2
RR18L 62HG SAN10 170S SPK10 VW1CZ T1HF54 HU46T2
RT11 X16 SAN11 70S SQU10 192 T19HF66 HU66T5
RT11P P1771CR SC1041R SC1041R SQU11 192B T19HO107 HD107-PT5
RT12 CE5 SC1041S SC1041S SR1000V SR1000V T19H088 HD106-PT5
RT12P AA3 SC1247 SC1247 SRX11 SX1 T19MA34L MAZ24RT5
RUK10 RK1 SC1400 SC1400 SRX12 SU9L T19S32FJ TBE1T5
RUK11 R67P SCL10 SHH1 SRX14 SX3 T19SK31L SK22RT1
RUK11L 67P SCR10 STA1 SRX15 SX4 T19SP27A GT16T2
RUK12 67Q SCR11 STA2 ST10 SEIB T19TY51A TOY43AT4
RUK12L R67Q SHA10 62SH ST10 SEIC T30H72 H72PT
RUK13 67N SHG11 SHA-1 ST12 F54 T30H73 H73PT
RUK13L R67N SI10 SM1 STB10 62FE T31LXP90 TOY40BT4
RUK14 67U SI11 VC30 STB11 SR4 T33P1795 YI 60-PT
RUK14L RK3 SI12 VC31 STB12 SR1 T41VW25A HU49AT2
RUK16 RU91C SIS10 1523 STB12L SR2 TB10 DB1
S1000V S1000V SK100 FB5 STB13 SR5 TB10L DB2
S1042Z S1042Z SK130 FB3 STS10L SN1 TBP CE2
S1042ZM S1042ZM SK19 65CF STV10 ST91F TH10 1148
S1042ZS S1042ZS SK210 FB7 STV10L ST91V TJC BL2
S1069G S1069G SK22 FB7 STV11 SV3 TKA10L VL1
S1069H S1069H SK24 FB1 STV11L SV3 TKA11 66E
S1069M S1069M SLC10 SM6 STV12 ST91S TKA11L R66E
S1096G S1096G SLC11 SES91 STV12L ST91 TKA12 ER10
S10LAAP S10LAAP SLC11L SR65 STW1 1568 TKA12L ERS3
S10MTK MTK1 SLC12 S65F SU10 SUZ1 TKA13 ER9
S10PE PE1 SLC12L R65F SU10 SUZ6 TKA13L ERS8
S10PEP PE1 SLC13 SEL91 SU10L SUZ2 TKA14 ERS6
S1176 S1176 SLC13 U65F SU10L SUZ7 TKA14L ERS5
S11ABY AL1 SLC13L SEL91R SU11 SUZ3 TO10 TO1
S11ABYP AL1-BLK SLE10 EX1 SU11 SUZ8 TO20 TO2
S12KBA KA5-SI SMG10 SIM2 SU11L SUZ4 TO30 TO3
S12KE KE3-SI SMG10L D1098BM SU11L SUZ9 TO40 TO4
S13KE S13KE SMG11 S91A SU12 SUZ5 TO50 TO5
S16CHGT 11378 SMG12 S91BV SU13 HD57 TO60 TO6
S18FCT FH4 SMG13 S91CV SU13 SUZ10 TO70 TO7
S1CHGT 1136S SMG14 S91K SU13L HD56 TO8 TO8
S1LPS KS1 SMG15 SIM1 SU13P HD57 TOK10 TO91
S20KBA KAB2 SMG17 SIM3 SU13P SUZ10 TOK10X TK13
S21ABS AB32 SMG17 SIM8 SU14 SUZ11 TOK10Y TK31
S2CHGT L1137 SMG18 SIM10 SU14 X87 TOK11 TK3
S30FDP S30FDP SMG18L SIM9R SU14p SUZ11 TOK11Y TK32
S32FJP S32FJP SMG20 S91P SU20L SUZ12 TOK12 TK1
S32YSP S32YSP SMG22 S91P SU20L X179 TOK12X TK15
S33FDP S33FDP SMG23L S91R SU20LP SUZ12 TOK12Y TK33
S33FJP S33FJP SOS10 SOS91 SU21L SUZ17 TOK13X TK16
S34YSP S34YS-P SOS11 SO91P SU21L X186 TOK13Y TK34
S3FDP S3FDP SOS12 SOS1 SU21LP SUZ17P TOK14X TK17
S48HFP S48HFP SOS13 R65S SU22 SUZ15 TOK14Y TK35
S49HFP S49HFP SP11 NE9 SU22 X185 TOK15X TK18
S50HFAP S50HF-P SP12 NE19 SU22P SUZ15P TOK16X TK19
S50HFP S50HFP SP12 NE23 SW1 SANI TOK16Y TK37
S53HFP S53HFMP SP12P NE19 SWA10L SW2 TOK17X TK20





ORION	ILCO	ORION	ILCO	ORION	ILCO	ORION	ILCO	ORION	ILCO
TOK17Y	TK38	TY28	1519	UN19	62DP	UN61	62DB		
OK18X	TK21	TY28	MS13	UN2	62DX	UN62L	S33C		
TOK18Y	TK39	TY35	TR33	UN20	B62DP	UNL4	WA91W		
TOK1X	TK4	TY35	X137	UN21	62FS	UNL4L	WA91	ORION	ILCO
TOK1Y	TK22	TY35LP	DC1-P	UN22	F70S	UNL5	WA91WL	VA45	H7LDH
TOK2X	TK5	TY35P	TR33P	UN23	H62DR	UNL5L	WA91L	VA53	SM12
TOK2Y	TK23	TY36	TR37	UN23L	BR18R	URK10	UR3	VA55L	VC34
TOK3X	TK6	TY36	X159	UN24	62DK	URK10L	UR3R	VA57	H62DM
TOK3Y	TK24	TY36P	TR28P	UN25	UN1	URK4PL	UR2	VA58	H62CM
TOK4X	TK7	TY36P	TR37	UN26	UN16	VA1	VAE1	VA68	H62BM
TOK4Y	TK25	TY37	TR39	UN27	62DE	VA10	61VT/V1S	VA70	RN29
TOK5X	TK8	TY37P	TR39	UN28	BR9	VA11	62KD	VA73	L62KE
TOK5Y	TK26	TY38	TR37	UN29	MG1	VA12	VC28	VA75	NE46
TOK6X	TK9	TY38P	TR28-P	UN29P	MG1	VA12L	VC34	VA75	RN29
TOK6Y	TK27	TY39	TR33	UN30	S62DP	VA13	VC32	VA75	X122
TOK7X	TK10	TY39P	TR33P	UN31	B62DR	VA13L	VC33	VA75P	RN29
TOK7Y	TK28	TY40	TR25	UN32	S62DR	VA14	H10F	VA80	PG5
TRC30	TR15D	TY40p	TR25	UN34	62DA	VA15	H62KB	VCO10	VEC2
TRL10	TK41	TY41	TR40	UN35	62DJ	VA16	VAT1	VCO10L	VEC1
TSA11	TE3	TY41	X174	UN36	UN5	VA17	63PX	VGA10	VG2
TSA20	TE1	TY41P	TR40P	UN37	L62DM	VA17L	R63PX	VNG10	VG1
TSA20L	TE2	TY45	TR25	UN38	S33P	VA17P	63PX	VNG13	VGY1
TSA22	GR10	TY46	TR49	UN41	UN51	VA18	VC24	VRO3P	VR91CR
TSA22	TE4	TY46	X218	UN41L	UN61	VA19	VC25	VRO3PL	VR91C
TTM	CE8	TY48	TR44	UN42	UN52	VA20	VC26	VRO4	VR91S
TTN14	TT91	TY48	X211	UN42L	UN62	VA21	VC27	VRO4L	SR191A
TTN16	TT1	TY48P	TR44P	UN43	UN50	VA22	VC29	VRO4P	VR91B
TY10	TA2	TY49	TR46	UN43L	UN60	VA23	VC22	VRO4PL	VR91BR
TY10L	TA12	TY49	X212	UN44	UN58	VA24	H7RDH	VRO5	VR91
TY11	TA5	TY49P	TR46P	UN44L	UN68	VA25	V91E	VRO5L	VR91R
TY11L	TA4	TY50	TR50	UN45	UN53	VA26	VC21	VRO5P	VR91AR
TY12	TA11	TY50	X220	UN45L	UN63	VA27	H7RA	VRO5PL	VR91A
TY12L	TA16	TY51	TR47	UN46	UN54	VA27L	H7LA	VRO5X	VR1R
TY13	TA8	TY51	X217	UN46L	UN64	VA28	H7RB	VR05XL	VR1R
TY13	TA9	TY51P	TR47P	UN47	UN57	VA28L	H7LB	VS10	VS1
TY13L	TA6	TY52	TR48	UN47L	UN67	VA29	H7RC	VW10	61VW
TY14	T61C	TY52	X219	UN48	UN56	VA29L	H7LC	VW11	U61VW
TY14A	TA28	TY53	TR53	UN48L	UN66	VA30	H7RD	VW11L	V61VW
TY14LBP	T61C	TY53	X223	UN49	UN59	VA30L	H7LD	VW12	FT3F
TY14LP	DC1-P	TY53P	TR53P	UN49L	UN69	VA31	H7RE	VW12L	FT3
TY14LP	T61C-P	UCM5S	UCM1	UN50	771NH	VA31L	H7LE	VW13	61VW
TY14P	T61CP	UMF10L	UM2	UN51	UN51L	VA32L	H7RE	VW13	62DW
TY15	TR28	UN10	62DM	UN51L	UN61L	VA34	H7RF	VW13	62VW
TY15P	TR28P	UN10L	R62DH	UN52	UN52L	VA34L	H7LF	VW13	S62DW
TY16	T61F	UN10L	R62DM	UN52L	UN62L	VA35	H7LF	VW13	W62VB
TY16AP	P1098V	UN11	62DO	UN53	UN50L	VA35L	H7RF	VW14	HF35
TY17	T61D	UN11	BR12	UN53L	UN60L	VA36	H7RG	VW14L	VW67
TY18	TA21	UN12	1033N	UN54	UN58L	VA36L	H7LG	VW14LP	V27
TY18	TA26	UN13	U180G	UN54L	UN68L	VA37	H7LG	VW14LP	V67
TY19	TA19	UN14	B62DV	UN55	UN53L	VA37L	H7RG	VW14LP	VW67
TY20	TR26	UN14	WA2	UN55L	UN63L	VA38	H7RH	VW15	VW67S
TY22	TA25	UN14L	BS62DV	UN56	UN54L	VA38L	H7LH	VW15P	VW67S
TY23	TA7	UN14L	WA1	UN56L	UN64L	VA39	H7LH	VW16	VW20
TY24	TA24	UN15	62DG	UN57	UN57L	VA39L	H7RH	VW17	U62VN
TY25	TR25	UN15	H62DG	UN57L	UN67L	VA40	H7RDH	VW18	73VB
TY25BP	TA27	UN15L	HR62DG	UN58	UN56L	VA40L	H7LDH	VW18BP	73VBP
TY25BP	TR25	UN15L	R62DG	UN58L	UN66L	VA42	V91N	VW18HP	73VB-P
TY26	TA15	UN16	H62DP	UN59	UN59L	VA43	VCA1	VW18HP	73VBP
TY27	TA23	UN17	62FT	UN59L	UN69L	VA43L	VCA1R	VW18P	73VBP

CROSS REFERENCE





CROSS REFERENCE

	ORION	ILCO	ORION	ILCO	ORION	ILCO	ORION	ILCO
	WLY4	WA91W	YAL13G	999GG	YAL4	999B	YM13O	X48
	WLY4L	WA91	YAL13GL	999VG	YAL41A	999LA	YM14L	YH27
	WLY4P	WA91PR	YAL13H	999GH	YAL41AL	BVA1	YM14O	YH28
ORION	WLY4PL	WA91P	YAL13HL	999VH	YAL41AL	BYA1	YM16L	YH24
VW19	VW71	WA91WL	YAL13K	999GK	YAL41B	999LB	YM16O	YH29
VW19P	VW71	WA91L	YAL13KL	999VK	YAL41C	999LC	YM17L	YH38
VW19P	VW71V	TS1	YAL13L	999R	YAL41D	999LD	YM18L	YH44
VW20	VW71A	WRP10	YAL13L	X999R	YAL41E	999LE	YM19L	YH25
VW20P	VW71A	WRP13	YAL14	998	YAL41F	999LF	YM19O	YH26
VW22	V33	WS10	YAL14L	998R	YAL41FL	R9LF	YM23L	YH36
VW22P	V33	WS10L	YAL14L	998R	YAL41FL	R9LF	YM23L	YH36
VW23	73VB	WS10L	YAL15	999A	YAL41G	999LG	YM24L	YH30
VW23	PA8	WS11	YAL15	X999A	YAL41H	999LH	YM24O	YH32
VW25	V37	WS12	YAL15	998GA	YAL41H	999LH	YM24O	YH32
VW25	X203	WS13	YAL15A	998GA	YAL41K	999LK	YM25L	YM55
VW28	73VB	WS1LO	YAL15A	998VA	YAL41KL	R9LK	YM26L	YH34
WBR10	WC1	WS1O	YAL15B	998GB	YAL42A	998LA	YM26O	YM51-X75
WBR12	WC2	WS8	YAL15BL	998VB	YAL42AL	998YA	YM29	YH19
WCO10	WO1	WS9	YAL15C	998GC	YAL42B	998LB	YM29L	YH21
WCO11	WO2	WS10	YAL15C	998GC	YAL42B	998LB	YM29L	YH21
WCO12	WO3	WS110	YAL15CL	998VC	YAL42BL	998YB	YM30	YH37
WE10	VW64T	WS10	YAL15D	998GD	YAL42C	998LC	YM30L	YH38
WE11	62VE	WS11	YAL15D	998GD	YAL42C	998LC	YM30L	YH38
WE11	W62VE	WS11	YALL5DL	998VD	YAL42CL	998YC	YM31L	YH44
WEI11	A1054WB	WS11L	YAL15E	998GE	YAL42D	998LD	YM31L	YM43
WEI12	FL5G	WS1LO	YAL15EL	998VE	YAL42DL	998YD	YM32	YH35
WEI14	1054WC	X1000F	YAL15F	998GF	YAL42E	998LE	YM32	YM49
WEI14	N1054WB	X1000FR	YAL15FL	998VF	YAL42EL	998YE	YM32L	YH36
WEI15	A1054WC	X1014F	YAL15G	998GG	YAL42F	998LF	YM32L	YM48
WIL10	W91C	X1053	YAL15GL	998VG	YAL42FL	998YF	YM33	YH30
WIL11	WK7	X1054F	YAL15H	998GH	YAL42G	998LG	YM33	YH32
WIL13	WK26	X1054GA	YAL15HL	998VH	YAL42GL	998 YG	YM33L	YH30
WIL14	WK3	X1054GB	YAL15K	998GK	YAL42H	998LH	YM34	YM56
WIL15	WK17	X1054GC	YAL15KL	998GK	YAL42H	998LH	YM34	YM56
WIL15L	WK14	X1054GD	YAL15L	998VK	YAL42HL	998YH	YM34L	YM34
WIL16	WK13	X1054GE	YAL16	X999RA	YAL42K	998LK	YM34L	YM55
WIL17	WK3	X1054GE	YAL16	F1122A	YAL42KL	998YK	YM35	YM51X75
WIL19	WIL1	X1054GF	YAL16	H1122F	YAL43	999N	YM35L	Y50
WIL20	WK10	X1054K	YAL16L	F1122AR	YAL4P	H997EB	YM35L	YH34
WIL28	WK32	XPA1	YAL16L	H1122FR	YAL5	14KH	YM35L	YM50
WIL29	WK23	XPA2	YAL16L	O1122AR	YAL5	H999	YM35L	YM55
WIL30	WK20	YAL1	YAL17	997GX	YAL56	J997M	YM36	YH47
WIL31	WK29	997A	YAL17L	997GXR	YAL56L	J997MR	YM36AP	YH47
WIL32	WK25	997B	YAL18	YL5	YAL58	998GL	YM36L	YH46
WIL33	WK31	997DB	YAL19	997B	YAL58L	998YMK	YM36LAP	YH46
WIL34	WK28	997EB	YAL19	997EB	YAL5L	H999R	YM36LP	YH46
WIL35	WK22	R997EB	YAL19	997EB	YAL5L	H999R	YM36LP	YH46
WIL36	WK19	O1122	YAL19	YL8	YAL5P	H997E	YM36P	YH47
WIL37	WK27	O1122R	YAL2	O997K	YAL5PL	H997ER	YM37	YH49
WIL38	WK18	997D	YAL20	999	YAL6	14KH	YM37AP	YH49
WIL39	WK21	997E	YAL21	BKZ1	YAL60	998S	YM37L	X117
WIL4	WK12	Y200	YAL22	1702K	YAL83	999	YM37L	YH48
WIL40	WK30	997ER	YAL23	X1199G	YAL85	N01122D	YM37LAP	YH48
WIL41	WK24	999	YAL24	1764S	YAL88L	9C	YM37LP	YH48
WIL41	WK24	999GA	YAL24	D1759L	YAL88L	Y201	YM37P	YH46
WIL50	WK15	999VA	YAL24	S1767CH	YGO1	YU1	YM37P	YH49
WIL50L	WK16	999GB	YAL25	HR1132	YGO1P	YU1	YM38	YH51
WIL9	WK9	999VB	YAL25L	H1132	YM10L	YH20	YM38L	YH50
WLK4	61K	999GC	YAL26	1041T	YM10L	YH22	YM38LAP	YH50
WLK4L	R61K	999VC	YAL26L	1041TR	YM10O	YH16	YM38LP	YH50
		999GD	YAL27	E1122A	YM10O	YH23	YM38P	YH51
		999VD	YAL28	YL5	YM10O	YH9	YM40L	SUZ12
		999VE	YAL28	YL5	YM10O	YH9	YM40L	SUZ12
		999GE	YAL35	P1770U	YM12L	YH40	YM9L	YH41
		999VE	YAL36	999B	YM12O	YH43	YM9O	YH42
		999GF	YAL39	999N	YM13L	X33	YS10	62PG





ORION	ILCO	ORION	ILCO	ORION	ILCO	PPI	ILCO	ILCO	ILCO
YS10L	R62PG	ZEI52	ZKN1	ZEI551	ZK51	P96S	1396S		
YS11	R62PF	ZEI52L	ZKN1R	ZEI552	ZK52	SC1-6P-A	SY5-NS		
YS11L	62PF	ZEI17	CN5	ZEI553	ZK53	SC1-6P-B	SY6-NS		
YS12	62PH	ZEI18	ZK102	ZEI554	ZK54	SC1-6P-C	SY3-NS		
YS13	YM6	ZEI18L	ZKI100	ZEI555	ZK55	SC1-6P-G	SY8-NS		
YS14	YM7	ZEI2	60ZD	ZEI556	ZK56	Y766-000	885BL		
YS14L	YM8	ZEI22	ZMK1	ZEI557	ZK57	Y766-C10L	885R		
YS15	YM9	ZEI22L	ZMK2	ZEI558	ZK58	Y766-C10R	885		
YS16	MB16	ZEI2L	R60ZD	ZEI559	ZK59	Y766-C15L	886		
YS16L	MB16R	ZEI502	ZK2	ZEI560	ZK60	Y766-D2L	884R		
YS16P	MB16	ZEI503	ZK3	ZEI561	ZK61	Y766-D2R	884		
YS17	MB17	ZEI504	ZK4	ZEI562	ZK62				
YS17P	MB17	ZEI505	ZK5	ZEI563	ZK63	RUSSWIN	ILCO		
YS19	YM21	ZEI506	ZK6	ZEI564	ZK64	751	1011GH		
YS19A	OP12	ZEI507	ZK7	ZEI565	ZK65	5252	1011A		
YS19AL	OP37	ZEI508	ZK8	ZEI566	ZK66	5852	1011		
YS19L	YM22	ZEI509	ZK9	ZEI567	ZK67	5981	1011P		
YS20	YM23	ZEI510	ZK10	ZEI568	ZK68	5981	N1011P		
YS20L	YM24	ZEI511	ZK11	ZEI569	ZK69	5982	1011S		
YS21	OP43	ZEI512	ZK12	ZEI570	ZK70	5982	N1011S		
YS22	OP47	ZEI513	ZK13	ZEI571	ZK71	5983	N1011T		
YS22L	YM30	ZEI514	ZK14	ZEI572	ZK72	6961	A1011P		
YS22LP	YM30	ZEI515	ZK15	ZEI573	ZK73	6962	A1011S		
YS22P	YM29	ZEI516	ZK16	ZEI574	ZK74	6963	A1011T		
YS23	SAA1	ZEI517	ZK17	ZEI575	ZK75	9612	A1011M		
YS23TP	SAA1P	ZEI518	ZK18	ZEI576	ZK76	9812	N1011M		
YS24	MB39	ZEI519	ZK19	ZEI577	ZK77	5980-10K	1011K10		
YS24P	MB39P	ZEI520	ZK20	ZEI578	ZK78	5980-11K	1011K11		
YS25	MB40	ZEI521	ZK21	ZEI579	ZK79	5980-12K	1011K12		
YS25P	MB40	ZEI522	ZK22	ZEI580	ZK80	5980-13K	1011K13		
YS26	DK91H	ZEI523	ZK23	ZEI581	ZK81	5980-1K	1011K1		
YS27	YM16	ZEI524	ZK24	ZEI582	ZK82	5980-2K	1011K2		
YS28	YM13	ZEI525	ZK25	ZEI583	ZK83	5980-3K	1011K3		
YS31	HF59R	ZEI526	ZK26	ZEI584	ZK84	5980-4K	1011K4		
YS33	FT48	ZEI527	ZK26	ZEI585	ZK85	5980-5K	1011K5		
YS33P	FT48	ZEI527	ZK27	ZEI586	ZK86	5980-6K	1011K6		
YS35L	RN32	ZEI528	ZK28	ZEI587	ZK87	5980-7K	1011K7		
YS35LP	RN32P	ZEI529	ZK29	ZEI588	ZK88	5980-8K	1011K8		
YS5	SV4	ZEI530	ZK30	ZEI589	ZK89	5980-9K	1011K9		
YS6	L62VJ	ZEI531	ZK31	ZEI590	ZK90	5980-GGM	1011PZ		
YS6L	LR62VJ	ZEI532	ZK32	ZEI591	ZK91	5D12R	1011D12		
YS7	63TW	ZEI533	ZK33	ZEI592	ZK92	5D1R	1011D1		
YS7L	63TV	ZEI534	ZK34	ZEI593	ZK93	5D2R	1011D2		
YS8	M63E	ZEI535	ZK35	ZEI594	ZK94	5D34R	1011D34		
YS8L	MR63E	ZEI536	ZK36	ZEI595	ZK95	5D3R	1011D3		
YS9	R63E	ZEI537	ZK37	ZEI596	ZK96	5D41R	1011D41		
YS9	R63KE	ZEI538	ZK38	ZEI597	ZK97	5D4R	1011D4		
YS9L	63E	ZEI539	ZK39	ZEI598	ZK98	6960-10N	A1011-10N		
YTI11	T67E	ZEI540	ZK40	ZEI599	ZK99	6960-11N	A1011-11N		
YTI13	T67F	ZEI541	ZK41	ZNI5	ZN1	6960-12N	A1011-12N		
YTI21	T67A	ZEI542	ZK42			6960-13N	A1011-13N		
YTI23	T67D	ZEI543	ZK43	PPI	ILCO	6960-14N	A1011-14N		
ZD15	X47	ZEI544	ZK44	DI-1	1028	6960-15N	A1011-15N		
ZEI10	ZIK1	ZEI545	ZK45	DI-2	1052A	6960-16N	A1011-16N		
ZEI10L	Z91KR	ZEI546	ZK46	LB-2	LB2	6960-17N	A1011-17N		
ZEI11	ZK1	ZEI547	ZK47	P-1	1333	6960-18N	A1011-18N		
ZEI12	S60	ZEI548	ZK48	P-175	1028P	6960-19N	A1011-19N		
ZEI12L	S60R	ZEI549	ZK49	P60S	1334	6960-1N	A1011-1N		
ZEI15	ZE91G	ZEI550	ZK50	P87	1388	6960-20N	A1011-20N		

RUSSWIN	ILCO
6960-21N	A1011-21N
6960-22N	A1011-22N
6960-23N	A1011-23N
6960-24N	A1011-24N
6960-25N	A1011-25N
6960-26N	A1011-26N
6960-27N	A1011-27N
6960-28N	A1011-28N
6960-2N	A1011-2N
6960-3N	A1011-3N
6960-4N	A1011-4N
6960-5N	A1011-5N
6960-6N	A1011-6N
6960-7N	A1011-7N
6960-8N	A1011-8N
6960-9N	A1011-9N
6960-GGM	A1011PZ
6960-GGMR	A1011PZR
6D12R	A1011D12
6DIR	A1011D1
6D2R	A1011D2
6D34R	A1011D34
6D3R	A1011D3
6D41R	A1011D41
604R	A1011D4
6H1R	A1011H1
6H2R	A1011H2
6H3R	A1011H3
6H58R	1011MK
752B	1012
752-GGM	1011M
7D1R	B1011D1
7D2R	B1011D2
7D3R	B1011D3
7D4R	B1011D4
861B	1011B
861UB	X1000KR
861UB	X1011KR
	SAMSONITE
	SAMSONITE ILCO
181	170S1
170S	170S
70S	70S
80S	80S
S181	S170S1
S96	170S6
	SARGENT
	SARGENT ILCO
265B	1008
265D	O1009
265K	1010
265R	1009
265U	1010U
265U	O1010
265UT	1010T

CROSS REFERENCE

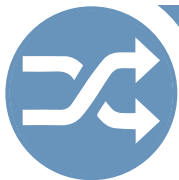

SARGENT ILCO

270LD 1007LD
 270LDH 1007LDH
 270LDM 1007LDM
 270LH 1007LH
 270LHM 1007LHM
 270LM 1007LM
 270LN N10007KMB
 270LN O1007KM
 270RD 1007RD
 270RDH 1007RDH
 270RDM 1007RDM
 270RHM 1007RHM
 270RM 1007RM
 270RN N1007RMB
 273CD 1007CD
 273CH 1007CH
 273CM 1007CM
 273CN 1007CN
 275LA 1007LA
 275LB 1007LB
 275LC 1007LC
 275LE 1007LE
 275LF 1007LF
 275LG 1007LG
 275LJ 1007LJ
 275LK 1007LK
 275LL 1007LL
 275RA 1007RA
 275RB 1007RB
 275RC 1007RC
 275RE 1007RE
 275RF 1007RF
 275RG 1007RG
 275RJ 1007RJ
 275RK 1007RK
 275RL 1007RL
 275SA 1010N
 278CA 1007CA
 278CB 1007CB
 278CC 1007CC
 278CE 1007CE
 278CF 1007CF
 278CG 1007CG
 278CJ 1007CJ
 278CK 1007CK
 278CL 1007CL
 6265B 1008A
 6265K 1010SA
 6265KE O1007JA
 6265R 1009A
 6265U A1010U
 6265U O1010A
 6270LD O1007LD
 6270LDHO1007LDH
 6270LDM O1007LDM

SARGENT ILCO
 6270LH O1007LH
 6270LHM O1007LHM
 6270LM O1007LM
 6270LN N1007KMA
 6270RD O1007RD
 6270RDH O1007RDH
 6270RDM O1007RDM
 6270RHM O1007RHM
 6270RM O1007RM
 6270RN N1007RMA
 6273CD O1007CD
 6273CDH O1007CDH
 6273CDM O1007CDM
 6273CH O1007CH
 6273CM O1007CM
 6273CN O1007CN
 6275LA O1007LA
 6275LB O1007LB
 6275LC O1007LC
 6275LE O1007LE
 6275LF O1007LF
 6275LG O1007LG
 6275LJ O1007LJ
 6275LK O1007LK
 6275LL O1007LL
 6275NB O1007NB
 6275RA O1007RA
 6275RB O1007RB
 6275RC O1007RC
 6275RE O1007RE
 6275RF O1007RF
 6275RG O1007RG
 6275RJ O1007RJ
 6275RK O1007RK
 6275RL O1007RL
 6275SA L1010N
 6278CA O1007CA
 6278CB O1007CB
 6278CC O1007CC
 6278CE O1007CE
 6278CF O1007CF
 6278CG O1007CG
 6278CJ O1007CJ
 6278CK O1007CK
 6278CL O1007CL
 6278CR O1007CR
 7270LD L1007LD
 7270LH L1007LH
 7270LM L1007LM
 7270LN 1007KM
 7270LN N1007KMC
 7273CD L1007CD
 7273CH L1007CH
 7273CM L1007CM
 7273CN L1007CN
 7275LA L1007LA
 7275LB L1007LB
 7275LC L1007LC
 7275LE L1007LE

SARGENT ILCO
 7275LF L1007LF
 7275LG L1007LG
 72751J L1007LJ
 7275LK L1007LK
 7275LL L1007LL
 7278CA L1007CA
 7278CB L1007CB
 7278CC L1007CC
 7278CE L1007CE
 7278CF L1007CF
 7278CG L1007CG
 7278CJ L1007CJ
 7278CK L1007CK
 7278CL L1007CL
 F258BF 1010B

S & G
 S & G ILCO
 53 1028D
 60 1063B
 89 10630
 90 1089C
 91 1388L
 92 A1124
 96 1063E
 9609 1362
 60G 1068B
 87G 1387G
 87H SG4
 87H 1387
 89A 1390
 89AG 1390G
 89G 1389G
 92H 1063
 96G 1068E
 SY3B 887

SCHLAGE ILCO
 1246-6 SC1246
 1248-6 SC1248
 1348-6 SC1348
 1467-6 SC1467
 1468-6 SC1468
 35-009-C123 C123
 35-009-C145 C145
 35-056-C 101C LFIC CONTROL
 35-056-E 101E LFIC CONTROL
 35-100C 1145
 35-100CE 1145CE
 35-100E 1145E
 35-100EF 1145EF
 35-100F 1145F
 35-100FG 1145FG
 35-100G 1145G
 35-100H 1145H
 35-100J 1145J
 35-100K 1145K
 35-100L 1145L

SCHLAGE ILCO
 35-101C 1145A
 35-101CE A1145CE
 35-101E A1145E
 35-101EF A1145EF
 35-101F A1145F
 35-101FG A1145FG
 35-101G A1145G
 35-101H A1145H
 35-101J A1145J
 35-101K A1145K
 35-101L A1145L
 35-180 1307A
 35-181 LI 307A
 35-182 R1307A
 35-200 1307W
 35-201 L1307W
 35-202 R1307W
 922B O1054A

SECURITY CORP
 SECURITY ILCO
 KD73-7 SY11
 KD73-L SY12
 KD76 SY10

SEGAL ILCO
 SEGAL ILCO
 65 O1022AB
 68 R1022L
 69 1022AB
 79 O1022E
 K2 1022HR
 K5 O1022
 K8 1022L
 K9 1022

SILCA ILCO
 SILCA ILCO
 AB10 AB-18
 AB10R AB21
 AB14 191AB
 AB15R AB16
 AB16R AB11
 AB16R AB15
 AB17R AB12
 AB19 AB23
 AB2 AB62C
 AB3 AB62E
 AB32 AB32
 AB38P AB38P
 AB3R AB62ER
 AB4 AB9
 AB43 AB43
 AB60P AB60P
 AB8 AB19
 AB8R AB20
 AB9 AB62A
 ABS2 1635J
 ABS2 SF11
 ABS2R 1635V
 AC1 UCM1
 AD2 ALP7

SILCA ILCO
 AF14A 61H
 AF14A YR62
 AF14B R61H
 AF14 B Y62
 AF1A AL4
 AF1A DR61F
 AF1A F24
 AF1A F25
 AF1A F38
 AF1A R61D
 AF1A R63ST
 AF1A SE4B
 AF1A SP1
 AF1B 61D
 AF1B F26
 AF1B F38
 AF1B F39
 AF1B R63TS
 AF1B SP2
 AF1C 61TS
 AF1C 63ST
 AF1C F27
 AF1C F28
 AF1C F40
 AF1C SP3
 AF1D 63TS
 AF1D F30
 AF1D F37
 AF1D F41
 AF1D R61TS
 AF1D SP4
 AF2A AB1A
 AF2A LR61D
 AF2A R62TS
 AF2A AB2B
 AF2B L61D
 AF2B 61F
 AF2C AB3C
 AF2D AB4D
 AF2D SP5
 AF3A AL2
 AF3A R61G
 AF3B 61G
 AF3B AL1
 AF4A F91C2
 AF4B F91C
 AF4C F91CR
 AF4D F91C
 AF4D F91C8
 AF5A F91E
 AF5A F91ES
 AF5A R63SP
 AF5B 63SP
 AF5B F91F
 AF5B F91FS
 AF5C F91G
 AF5C F91GS
 AF5D F91H
 AF5D F91HS





SILCA	ILCO	SILCA	ILCO	SILCA	ILCO	SILCA	ILCO	SILCA	ILCO
AF7A	FT37	ASS13	AS15	ASS38R	AR61W	AW18R	A1179S		
AF7AP	FT37	ASS136R	AS14L	ASS3R	AR61T	AW19R	A1179T		
AF7C	FT38	ASS13R	AS13	ASS40	A61Q	AW2	1025AR		
AG1R	AG2	ASS13R	AS9	ASS40R	AR61Q	AW2	760	SILCA	ILCO
AG2	AG1R	ASS14	AS16	ASS42	AS24	AW20R	A1179U	BES20	B1179-1C
AG2R	AG1	ASS149	61X	ASS42R	AS26	AW21R	A1179V	BES21	B1179-1D
AG3	AU3	ASS14R	AS14	ASS43	SB7	AW5	1179A	BES3	A1114C
AG3R	AU4	ASS14R	AS9L	ASS45	AS84	AW6	N1179	BES4	A1114D
AG4	AU1	ASS15	AS19	ASS46	SB8	AW7	1179	BES5	A1114E
AG4R	AU2	ASS15R	AS17	ASS49	SB10	AW8R	A1179E	BES6	A1114F
AGE1	AG5	ASS16	AS20	ASS49P	SB10	AW9R	A1179F	BES7	A1114G
AGE3	AG1	ASS16R	AS18	ASS4R	AS74	AY1	ABL1	BES8	A1114H
AGE4R	AG4	ASS17	AS55	ASS5	SB6	AY1	AL1	BES9	A1114J
AK1	VW64	ASS17R	AS21	ASS52	AS80	AY13	AY13	BH10	AL5
AK1R	R63VS	ASS18	AS56	ASS52R	AS82	AZ1	AZ2R	BH10	KL1
AK1R	VW64R	ASS18R	AS22	ASS59	AS90	AZ1R	AZ2	BH11	H76U
AK2	AD1	ASS19	AS45	ASS60	AS89	B100-PT	B100-PT	BH4	NE10
AK2	AU14	ASS19R	AS43	ASS61	AS86	B100-PT5	B100-PT5	BH4P	NE10
AK2	AUC	ASS1R	SB11	ASS64	AS71	B103-PT	B103-PT	BH6	BH1
AKR1	AK1	ASS2	61W	ASS64R	AS73	B103-PT5	B103-PT5	BH7	BH3
AKR1	AN1	ASS20	AS46	ASS65	AS63	B104-PT	B104-PT	BK1	DA3
AKR2	AK2	ASS20R	AS44	ASS65R	AS61	B104-PT5	B104-PT6	BK1	KS91C
AKR2	AN3	ASS21	AS37	ASS66	AS65	B97-PT	B97-PT	BK1R	DA2
AKR3	AN2	ASS21R	AS35	ASS66R	AS67	B97-PT5	B97-PT6	BK3-1	BKS25
AKR4	AK6	ASS22	AS38	ASS67	AS57	B98-PT	B98-PT	BK3-10	BKS34
AKR5	AK4	ASS22R	AS36	ASS67R	AS59	B98-PT5	B98-PT5	BK3-11	BKS35
AKR6	AN2	ASS23	AS39	ASS7	AS75	B99-PT	B99-PT	BK3-12	BKS36
ALP1	ALP4	ASS23R	AS69	ASS73	AS79	B99-PT5	B99-PT5	BK3-2	BKS26
ALP15R	ALP15R	ASS24	AS40	ASS73R	AS81	BA1	1098M	BK3-3	BKS27
ALP2	ALP5	ASS24R	AS70	ASS7R	AS77	BA2	H1098LA	BK3-4	BKS28
ALP5R	A190	ASS25	AS29	ASS8	AS76	BA2	O1098LA	BK3-5	BKS29
ALP7R	ACP3	ASS25R	AS27	ASS80	AS64	BA2R	O1098LA	BK3-6	BKS30
ALP8R	ALP2	ASS26	AS30	ASS80R	AS62	BA3	X1199B	BK3-7	BKS31
AM1	DM20	ASS26R	AS28	ASS81	AS66	BA4	X1199G	BK3-8	BKS32
AM2R	NE56	ASS27	AS49	ASS81R	AS68	BA5	O1122A	BK3-9	BKS33
AM2R	X113	ASS27R	AS47	ASS82	AS58	BA5R	1125M	BK5-10	BKS2
AM2RP	NE56	ASS28	AS50	ASS82R	AS60	BA5R	O1122AR	BK5-11	BKS3
AMK1	AK22W	ASS28R	AS48	ASS8R	AS78	BA7R	1125G	BK5-12	BKS4
AML1R	1041C	ASS29	AS51	ASS9	61T	BA7R	1125H	BK5-13	BKS5
AML2R	A1045	ASS29R	AS53	ASS98	SR61W	BA8R	1098DB	BK5-14	BKS6
AML3R	1045	ASS2R	R61W	ASS9R	R61T	BA8R	ELM1	BK5-15	BKS7
AN1	H61V	ASS3	A61T	AT1	AT1	BA8R	H1098DB	BK5-16	BKS8
AR10	SP8	ASS30	AS52	AT1R	AT2	BAB29	BAB29	BK5-17	BKS9
AR4	SF9	ASS30R	AS54	AT2R	AT3	BAL1	BA1	BK5-18	BKS10
AR6R	SF7AF	ASS31	61Q	AU1	AA3	BAL3	BA2	BK5-19	BKS11
AR7	SF8	ASS31R	R61Q	AU1R	LF13	BAS1	BAS1	BK5-20	BKS12
AR8	SP6	ASS32	AS6	AUS1	AUS1	BE200	BE91S	BK5-21	BKS13
AR9	SP7	ASS32R	AS8	AW1	1025	BE201	BE91C	BK5-22	BKS14
ARC1	1130R	ASS33	AS5	AW1	1025A	BE202	BE91	BK5-23	BKS15
ARC1R	1130	ASS33R	AS7	AW1	750	BE203	BE91L	BK5-24	BKS16
ARC2	1131R	ASS34	AS10	AW1	755U	BES1	A1114A	BK5-25	BKS17
ARC2R	1131	ASS34R	AS12	AW10R	A1179G	BES10	A1114K	BK5-26	BKS18
ASS1	V61A	ASS35	AS9	AW11 R	A1179H	BES11	A1114L	BK5-27	BKS19
ASS10	AS23	ASS35R	AS11	AW12R	A1179J	BES12	A1114FM	BK5-28	BKS20
ASS10R	AS25	ASS36	AS34	AW13R	A1179K	BES16	A1114Q	BK5-29	BKS21
ASS11	AS1	ASS36R	AS32	AW14R	A1179L	BES17	A1114R	BK5-30	BKS22
ASS11R	AS3	ASS37	AS33	AW15R	A1179N	BES18	A1114M	BK5-31	BKS23
ASS12	AS2	ASS37R	AS31	AW16R	A1179P	BES19	A1114TB	BK5-32	BKS24
ASS12R	AS4	ASS38	A61W	AW17R	A1179R	BES2	A1114B	BL1	BL91

CROSS REFERENCE

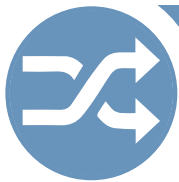

SILCA

BL1R
BLL1
BLL2
BLL3
BLL4
BLL5
BLO1
BLO1R
BLV1R
BLV2R
BLV3
BMB1R
B02
BO2
BO4
BO4
BO5
BO5
BO6
BO6
BO6
BO6R
BO6R
BOR1
BOR1R
BRG1R
BRG2
BRG3
BRG4
BRG5
BRG6
BRM1
BT1
BT1R
BT2
BT2R
BUR1
BUR11
BUR11
BUR16
BUR17R
BUR1R
BUR2
BUR2R
BUR3R
BUR4
BUR6
BUR7
BVA1
BVA1R
BW1
BW1
BW3
BW3
BW4

ILCO

BL2
BEL3
BEL4
BEL5
BEL6
BEL7
BLO1
BLO1R
1036
1036S
1036G
BMB1R
62VH
OP91
63F
BO4
B62G
DK91
63WG
B02
H62VG
B091
HR62VG
R63WG
R1003M
1003M
K1122D
L1098M
K1122B
K1122C
K1122N
L1054M
BR1
BU2
BU1
BU8
BU7
BUR11
BUR5
BUR13
BUR1
BUR12
BUR7
BUR8
BUR3R
BUR4
BUR6
BUR9
BV1
BV2
63VP
HF20
BM3
NE8
BM4

SILCA
BW4
BW4
BW5
BW5
BW6
BW6P
BW7
BW7AP
BW7P
BW8
BY1
CA1
CA1
CA10
CA11
CA14
CA2
CA2R
CA2R
CA3
CA4
CA5
CA7
CA7
CA9
CB1
CB1
CB11
CB11R
CB12
CB12R
CB13
CB13R
CB14
CB14R
CB18
CB20
CB22R
CB23R
CB24R
CB25R
CB26R
CB27R
CB28R
CB29
CB29R
CB3
CB33B
CB33B-A1
CB33B-A2
CB33B-B1
CB33B-B2
CB33B-C1
CB33B-C1
CB33B-C2
CB33R-D1
CB33R-D2
CB35

ILCO
WT1
WT3
BM9
KL4
VW63
BMW1
BMW1
BMW3-P
BMW2-P
HF40
BY1
CA91S
CAV91
AR62K
UR62K
ZC1
CA91L
ZE91C
ZE91CR
CA91B
CA91A
CA91
CA91C
CA91D
KVR91
CB3
1001DH
R1001EN
1001EN
A1001MJR
B1001EJ
R1000V
1000V
SR1000V
S1000V
1001GH
CB10
L1001GRM
A1001GRM
1001GRM
L1001EH
A1001EH
1001EH
L1003AB
R1001EG
1001EG
CB2
A1001AH
A1001AH
A1001FH
A1001BH
A1001DH
A1001C
A1001C1
A1001C2
A1001D1
A1001D2
XO1000GR

SILCA
CB35R
CB36R
CB37
CB38
CB38R
CB39R
CB4
CB40R
CB41R
CB44R
CB45R
CB46R
CB47
CB47R
CB48
CB49
CB49R
CB50
CB50R
CB51
CB52R
CB53
CB54R
CB55R
CB57R
CB59
CB6
CB60
CB61R
CB62R
CB63R
CB64R
CB65R
CB66B
CB67R
CB68R
CB69
CB71
CB72
CB73
CB74
CB75
CB76
CB77
CB9
CE1
CE10
CE11
CE12
CE13
CE13R
CE14-15
CE14-16
CE14-17
CE14-18
CE14-25
CE14-26
CE14-27
CE 4-28

ILCO
XO1000F
1000AB
R1001EF
SX1000FR
SX1000F
1001EB
CB1
L1001AH
1001AH
LH1
1000
R1001EE
1000F
1000FR
X1000G
R1000T
1000T
R1000V
1000V
1000X
A1001ABM
1001GH
1001
S1000V
1001ABR
S1000X
CB7
S1000XK
1001EA
1003A
1003AB
A1001AM
A1001BM
L1003A
L1003M
S1000T
1000XK
A1011-L1
A1011-L2
A1011-L3
A1011-L4
A1011-L12
A1011-L34
A1011-L41
CB12
L62US
CS28
CS1
S62US
CS14
CS15
CS44
CS45
CS46
CS47
CS48
CS49
CS50
CS51

SILCA
CE14-35
CE14-36
CE14-37
CE14-38
CE14-45
CE14-46
CE14-47
CE14-48
CE-15
CE1R
CE2
CE22-16
CE2R
CE34
CE35
CE36
CE4
CE4
CE4
CE4R
CE5
CE7
CE7R
CE8
CEM1
CEM2
CEM3
CEN1
CH1
CH10
CH11
CH12
CH13
CH14
CH15
CH16T
CH17T
CH18
CH19
CH2
CH20R
CH21
CH22
CH23
CH24R
CH25R
CH26R
CH27
CH3
CH4
CH5
CH6
CH7R
CH8
CH9T
CH9T
CHU6
CI4
CI4

ILCO
XO1000F
1000AB
R1001EF
SX1000FR
SX1000F
1001EB
CB1
L1001AH
1001AH
LH1
1000
R1001EE
1000F
1000FR
X1000G
R1000T
1000T
R1000V
1000V
1000X
A1001ABM
1001GH
1001
S1000V
1001ABR
S1000X
CB7
S1000XK
1001EA
1003A
1003AB
A1001AM
A1001BM
L1003A
L1003M
S1000T
1000XK
A1011-L1
A1011-L2
A1011-L3
A1011-L4
A1011-L12
A1011-L34
A1011-L41
CB12
L62US
CS28
CS1
S62US
CS14
CS15
CS44
CS45
CS46
CS47
CS48
CS49
CS50
CS51

SILCA
CE14-35
CE14-36
CE14-37
CE14-38
CE14-45
CE14-46
CE14-47
CE14-48
CE-15
CE1R
CE2
CE22-16
CE2R
CE34
CE35
CE36
CE4
CE4
CE4
CE4R
CE5
CE7
CE7R
CE8
CEM1
CEM2
CEM3
CEN1
CH1
CH10
CH11
CH12
CH13
CH14
CH15
CH16T
CH17T
CH18
CH19
CH2
CH20R
CH21
CH22
CH23
CH24R
CH25R
CH26R
CH27
CH3
CH4
CH5
CH6
CH7R
CH8
CH9T
CH9T
CHU6
CI4
CI4

ILCO
CS52
CS53
CS54
CS55
CS56
CS57
CS58
CS59
SH91K
LR62US
ST91A
BD6
R62US
CS32
CS30
CS31
CS2
SN2
ST91S
ST91
CS43
CS12
CS13
CS29
CE2
CE8
BL6
CE1
1041G
1041Y
104AM
101AM
102AM
103AM
100AM
1136S
L1137
1525
1041E
1041GA
1041TR
1041X
1041T
C1041J
SC1041R
SC1041S
S1041JA
C1041T
1041GB
1041GR
1041K
752
1042Z
1041N
1137B
1137S
1516
S62FD
CA3

SILCA
CL1
CL2
CL3
CL4
CL5
CLU1
CLU1R
CLU2
CLU2R
CLU3R
CLU3R
CLU4
CLU4R
CLU5
CLU5R
CN1
CNB1R
CNB2
COR1
CR4R
CS10
CS12
CS204
CS205
CS206
CS207
CS23
CS500
CS501
CS6
CS6R
CS7
CS7R
CS8
CS8
CS8R
CS9
CS9R
CTN1R
CTR1R
CVL1
CVL1R
CX7
CY1
CY1
CY10
CY11
CY12
CY12R
CY13
CY13R
CY14
CY14R
CY15R
CY16
CY16P
CY17P

ILCO
1040A
R1040C
1040C
R1040E
1040E
1573B
1573A
15730
1573C
1573F
1573E
1581H
1581G
1589J
1589I
C1054B
25
1558
CN1
CR4R
9CX
WA91S
S9CS
CS91B
9CS
R9CS
AB17
CS91
AB1
CS91CR
CS91C
CS91E
CS91ER
AB62FR
CS91FR
AB62F
CS91F
AB62G
AB62GR
1023
1560
CVL1R
CVL1
FSP2
1767CH
D1707K
1769CH
S1770U
CU8
CU7
CU10
CU9
CU12
1040U
P1786
Y153-P
P1789
Y154-P
MIT1



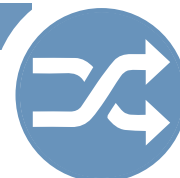

SILCA	ILCO	SILCA	ILCO	SILCA	ILCO	SILCA	ILCO	SILCA	ILCO
CY18	X213	DAT6BP	62DT	DM17	DM60	DM92	DM39		
CY19	P1793	DAT6P	62DT	DM17R	DM63	DM92R	DM49		
CY19P	Y155-P	DAT6R	X7	DM1R	DM5	DM93	DM40		
CY2	D1759L	DAT6RP	62DU	DM1R	FT6R	DM93R	DM50	SILCA	ILCO
CY2	S1767DP	DAT6RP	DA24	DM1RAP	FT6R	DM94	DM41	DX23R	DXC10
CY20	1793V	DAT7	62DV	DM1RP	FT6R	DM94R	DM51	DX24R	DXC20
CY21R	X1199AR	DAT7	X10	DM2	DO3M	DM95	DM42	DX25R	DXC30
CY22	P1794	DAT7RBP	SJ1	DM20	DM58	DM95R	DM52	DX26R	DXD10
CY22P	Y157-P	DAT9	X115	DM22	DM22-SI	DO10	22PO	DX27R	DXD20
CY23	1794V	DAT9BP	DA23-P	DM22TVP	DM22TVP	DO11	1054LB	DX28R	DXD30
CY24	P1795	DAT9P	DA23-P	DM23	D03M	DO12	N54B	DX29R	D1098X
CY24BP	Y159-P	DAT9R	X114	DM25	DM61	DO13	N54G	DX3	D1054KA
CY24CP	Y159-P	DAT9RP	DA24	DM26	DM25	DO1R	S54F	DX4R	DXB1
CY3	1701G	DB48R	DN1	DM3	ID1	DO2R	D06	DX5R	DXB2
CY3	1766S	DD1	D1V	DM39R	DM23	DO3R	DO5	DX6R	DXB20
CY3	S1767CH	DD2	D1T	DM4	64RD	DO4R	H1054F	DX7R	DXB3
CY4	P1770U	DD3	D1K	DM44R	DM26	DO5R	1054F	DX8R	DXC1
CY5	S1768CH	DD4	D1A	DM46	DM22	DO5R	L1054F	DX9R	DXC2
CY5	S1769CH	DF2	CA2	DM4R	DO1M	DO6	L54K	EF3R	EC12
CY5	S1770U	DF2	DF1	DM4R	PO2	DO7R	54FL	EF4R	EC14
CY6	L1098C	DH4R	TR40	DM50	DM25	DO8R	54FA	EF5R	EC16
CY7	P1770U	DH4RP	TR40	DM6	DO1SR	DO9R	P54F	EF6R	EC18
CY8	U1770CH	DL2	DL2	DM65-11	DM65-11	DU1	P65A	EG1	1014F
CY9	1768CH	DL3	LAP2	DM65-14	G195A	DU2	P65C	EG1	X1014F
DAT1	DT16	DM1	FT6	DM65-17	DM65-17	DU2R	P65C	EG2	O1014P
DAT1	DT4	DM10	DM31	DM65-18	G190A	DU3	HR62BZ	EG2R	O1014S
DAT10	62DT	DM10	HU4	DM65-2	G192A	DU3	PA91E	EG3R	1014
DAT12BP	DA25-P	DM103	DM57	DM65-20	DM65-20	DU3	R62BZ	EG4R	O1014J
DAT12P	DA25-P	DM10R	DM32	DM65-40	G194A	DU3R	H62BZ	EG5R	O1014JS
DAT12R	B54	DM11	DM11	DM65-41	G190BA	DU3R	PA91F	EG6	O1014P
DAT12R	X154	DM110	DM110	DM65-42	G190CA	DU4	1164K	EGO1R	EE1
DAT12RBP	B54	DM12-11	G199	DM65-43	G190DA	DU4	P64H	EL1	ELZ1
DAT13	X123	DM12-14	G195	DM65-44	G190EA	DU4	PA91H	ELG10	S1096G
DAT13P	DA25-P	DM12-15	G198	DM65-45	G190FA	DU4R	H64K	ELG1R	L1096CN
DAT14	DA28	DM12-17	G197	DM65-46	G190MA	DU4R	P64K	ELG2	H1054B
DAT14	DT20	DM12-18	G190	DM65-6	G194A	DU4R	PA91K	ELG3R	C1096LN
DAT14	X124	DM12-2	G192	DM65-8	G191A	DV1	DAV10	ELG4R	R1096EN
DAT14P	DA28	DM12-20	G196	DM65-9	G193A	DWO4RAP	DWO4RAP	ELG5	S1096B
DAT15	DA30	DM12-25	G200	DM66	DM8	DWO4RT5	DWO4RT5	ELG6R	C1096CN
DAT15	X197	DM12-40	6194	DM68	DM7	DWO5AP	DWO5AP	ELG7R	1096C
DAT15OP	DA30-P	DM12-41	G190B	DM69	DM6	DWO5RAP	DWO5RAP	ELG8R	1096
DAT16	DA28	DM12-42	G190C	DM6R	DO1S	DWO5RT5	DWO5RT5	ELG9R	10961
DAT16DP	DA28	DM12-43	G190D	DM7	DO4F	DWO5T5	DWO5T5	ER1	ER5
DAT1R	DT15	DM12-44	G190E	DM7	H64E	DX1	A1054KD	ERL1	1119
DAT1R	DT6	DM12-45	G190F	DM8	DM10	DX1	D1054K	ERL2	1119S
DAT2	DT5	DM12-46	G190M	DM86	DM33	DX10R	DXC3	ES1	ES1
DAT2R	DT1	DM12-6	G194	DM86R	DM43	DX11R	DXD1	ES1R	ES1R
DAT3	D72Z	DM12-8	G191	DM87	DM34	DX12R	DXD2	ESP1R	1503
DAT3R	D72D	DM12-9	G193	DM87R	DM44	DX13R	DXD3	ETA1	ET1
DAT3R	SR6	DM123-1	DM13	DM88	DM35	DX14R	DXB4	ETA1	ET2
DAT4	DT14	DM123-10	DM18	DM88R	DM45	DX15R	DXC4	ETA1	ET9
DAT4	DT8	DM123-2	DM16	DM89	DM36	DX16R	DXD4	EV2	EV4
DAT4R	DT13	DM123-3	DM15	DM89R	DM46	DX17R	DXG5	EV3	EVA1
DAT4R	DT7	DM123-4	DM14	DM8R	DM27	DX18R	54GM	EV3R	EVA1R
DAT5	MZ12	DM123-5	DM17	DM9	DM2	DX19R	54CM	EV4	62EV
DAT5	X1	DM14	D64	DM90	DM37	DX20R	54DM	EV4R	R62EV
DAT5BP	MZ12	DM15	DM3	DM90R	DM47	DX21R	54B1	EV5	EV5
DAT5P	MZ12	DM15	DO3L	DM91	DM38	DX21R	DXB10	EV6R	EV7
DAT6	X6	DM16	DM21	DM91R	DM48	DX22R	DXB30	EZ1	ES1

CROSS REFERENCE



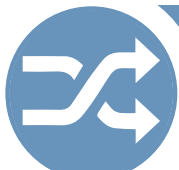

SILCA

FA2AP
FAB2
FB1
FB1
FB2
FB2
FB6R
FEB2R
FEB2R
FH1
FH2
FH3
FH6
FH7
FID1
FL1
FN2
FN3
FN4
FN6
FNA1
FO10
FO10AP
FO10P
FO11
FO11X
FO12
FO13
FO14R
FO14R
FO14R
FO14R
FO14R-ORS
FO14RP
FO15
FO16
FO17P
FO17R
FO18
FO18-OR
FO18P
FO19P
FO20P
FO21P
FO22R
FO22RBP
FO22RP
FO22RP
FO24
FO26
FO26-OR
FO26T3
FO27
FO27
FO27P

ILCO

NE58
X99
65CB
SK91A
65CD
SK91D
65CE
CF1
CF2
FTH3
FTH4
FT1
FTH5
FTH6
C172F
Z4
1054WC
A1054WC
A1054WD
1054WD
1552
X86
FC7-P
FC7-P
FC9
FC9
FC8
FC7
S1167FD
S1170LN
S1181FD
S1766LN
S1167FD
S1186TS-P
1127DU
FF1
P1127C
S167C
1184FD
1184FD
1186TS-P
S3FD-P
S33FD-P
S30FD-P
X202
X202
H59-P
MZ16
1186TS
1190LN
1184FD
H73-PT
1191ET
H59
H62-P

SILCA

FO28R
FO29
FO29BP
FO3
FO30
FO30BP
FO31R
FO31RAP
FO32R
FO32RAP
FO34
FO34AP
FO35
FO36BP
FO37R
FO38RT3
FO39
FO39CP
FO4
FO4
FO40R
FO40RBP
FO5
FO5
FO5
FO5
FO5
FO5
FO5
FO6
FO6
FO6
FO6
FO6-OR
FO7
FO8
FO9
FOT1
FOT1
FOT2
FOT2
FOT2
FOT3
FOT3
FOT3R
FOT3R
FOT3R
FOT3R
FOT4
FOT4
FOT4R
FOT4R
FOT5
FOT5
FOT5R
FOT5R
FOT6
FOT6R
FOT6R
FRT1
FRT2R

ILCO

X207
1193MU
H66-P
1127D
1193FD
H67-P
X221
H65-P
X221
H65-P
X231
H70-P
1185FD
1188LN-P
S1181FD
H72-PT
1195FD
H71-P
1127DP
1127FR
1196FD
H75-P
1127ES
S1127FL
S1127FR
S1127LC
S1127MU
1167FD
1170LN
1181FD
1766LN
1167FD
X20
BR20
CE6
62KT
FT4
FT5
KL2
VW77
FT7
H62FD
FT7R
HR62FD
V32
X53
FT9
HF22
FT9R
HF23
FT10
YM14
FT10R
YM15
X22
X21
YS1
L1054G
ML54G

SILCA

FRT3R
FS1
FS1R
FT4C
FT500
GAS1R
GB1
GB2
GB2
GB5
GB5R
GD2
GE1
GE17
GE17R
GE1R
GE2
GE3R
GE41
GE4R
GHE1
GHE2
GHE3
GM1
GM1
GM1
GM1
GM1-OR
GM1-OR
GM10
GM11
GM11
GM11P
GM12R
GM12RP
GM13R
GM14R
GM14RP
GM15
GM15
GM15P
GM16R
GM17R
GM17RP
GM18R
GM18R
GM18R
GM19
GM19
GM19
GM19P
GM19P
GM19P
GM1AP
GM1CP
GM2
GM2
GM2
GM2-OR
GM20
GM20P

ILCO

M54G
FAS1
ST1
FH4
FCT45
1098GX
GA91
GA1
GAS91
ZE91G
R62K
191A
GE5
GE2
GE4
GE3R
7GE
LR7GE
GE15
GE6
GH2
GH1
GH3
H1098A
L1098LA
O1098LA
P1098A
H1098A
P1098A
L98AS
B53
X143
B53
X145
B55
GM36
X146
P1098AV
P1098AV
B61
MIT1
MIT1
S1098WD
P1098WC
B64-P
B69
X180
B65
SUZ15
X184
B65
SUZ15
GMA-P
B48-P
H1098C
L1098C
P1098C
P1098C
X143
B53

SILCA

GM21R
GM21RP
GM22R
GM22R
GM22RP
GM23P
GM24R
GM24R
GM24R
GM24RP
GM25R
GM25R
GM25R
GM25R
GM25RP
GM25RP
GM26R
GM26RP
GM27R
GM27RP
GM28R
GM29
GM29P
GM2AP
GM2CP
GM3
GM3
GM3-OR
GM30
GM30AP
GM31
GM31P
GM32R
GM33R
GM34R
GM35R
GM36
GM37
GM37EP
GM38
GM39
GM39EP
GM3BP
GM3DP
GM4
GM4
GM4-OR
GM40
GM40EP
GM41
GM4BP
GM4DP
GM5
GM5-OR
GM5CP
GM6
GM6-OR
GM6DP
GM7
GM7-OR
GM7CP

ILCO

P1098CV
B63-P
B72
X192
B72
DC3
B74
X198
B74-P
K1994
P1100
P1108
B76-P
B88-P
P1098EV
B77-P
P1098WE
B78-P
S1098WH
P1099
B68-P
GMC-P
B50-P
O1098B
S1098B
S1098B
X225
B80-P
P1101
B84-P
1098GM
1098L
H1098DB
H1098M
H1098X
P1102
B82-P
1098XL
P1106
B86-P
GMB-P
B49-P
O1098D
S1098D
S1098D
P1109
B92-P
S1105
GMD-P
B51-P
P10986
P1098E
B44-P
S1098H
S1098H
B45-P
P1098J
P1098J
GMJ-P

SILCA

GM7CP
GM8
GM8-OR
GM8DP
GM8DP
GM9
GN1
GO1R
GO1R
G02R
GP1
GS4R
GT10
GT10BT5
GT12A
GT12A
GT12A
GT13A
GT13A
GT13A
GT13A
GT13B
GT15RAP
GT15RBT2
GT15RBT2
S1098B
X225
B80-P
P1101
B84-P
1098GM
1098L
H1098DB
H1098M
H1098X
P1102
B82-P
1098XL
P1106
B86-P
GMB-P
B49-P
O1098D
S1098D
S1098D
P1109
B92-P
S1105
GMD-P
B51-P
P10986
P1098E
B44-P
S1098H
S1098H
B45-P
P1098J
P1098J
GMJ-P

ILCO

P1098J
S1098K
S1098K
GMK-P
S1098K
LP98A
1033G
GL3
S62TG
GL1
GIP91
D1098B
NE57
GT10BT5
GT3
LN2
GT4
GT1
LN1
WA1
WA3
GT2
GT15RAP
GT15RAP
GT15RBT2
GT15RT2
SP25A-P
GT16T2
S10LAA-P
LN4
NE54
X167
NE54
YU2
X167
YU2
FT46
NE59
X152
FT46
X152-P
NE54
NE55
999GA
Y1GA
998GA
H998GA
999GB
998GB
H998GB
999GC
998GC
H998GC
999GD
998GD
H998GD
998GE
998GE
H998GE





SILCA	ILCO	SILCA	ILCO	SILCA	ILCO	SILCA	ILCO	SILCA	ILCO
GYF	999GF	HON24	HD40	HON39R	HD58	HON53AP	HD101-P		
GYF6	998GF	HON24	HON24	HON39R	HD75	HON53P	HD84-P		
GYF7	H998GF	HON24	X57	HON39RP	HD58	HON53P	HD92-P		
GYG	999GG	HON24P	HD40	HON39RP	HD75	HON54	HD1O2	SILCA	ILCO
GYG6	998GG	HON24P	HD72	HON39RP	HON39RP	HON54	HD85	HU14	HF6
GYG7	H998GG	HON24R	HO41	HON3R	HO61T	HON54	X189	HU14	HF9
GYH	999GH	HON24R	X58	HON4	HD14	HON54	X209	HU14	MB11
GYH6	998GH	HON24RP	HD73	HON4	HD5R	HON54AP	HD102-P	HU14	R63K
GYH7	H998GH	HON24RP	HO41	HON40	HD85	HON54P	HD102-P	HU14	R63TK
GYK	999GK	HON24RP		HON40	HD86	HON54P	HD85	HU14R	63K
GYK	Y1GK	HON24RP		HON40AP	HD85	HON54P	HD93	HU14R	HF16
GYK6	998GK	HON26	HD49	HON40AP	HD86	HON55R	X195	HU14R	HF5
GYK7	H998GK	HON27	67LD	HON40P	HD85	HON55R	X214	HU14R	MB12
GYK7	H998	HON2R	HO61S	HON40P	HD86	HON55RDP	HD98-P	HU15	OP60H
GYP7R	H998R	HON2R	R67K	HON41	HON41	HON56R	X204	HU15R	DK91S
H74-PT	H74-PT	HON3	HO61TR	HON42APHON	42AP	HON56REP	HD99-P	HU15R	R62PE
H82-PT	H82-PT	HON31	HD58	HON43R	HD88	HON57R	HD100	HU16	OP42
H86-PT	H86-PT	HON31	X138	HON43R	X172	HON57R	X205	HU17	62WB
HAW1	1597	HON31AP	HD56	HON43RP	HD88-P	HON57RP	HD100-P	HU17	AUBS3
HAW2	1598	HON31AP	HD75	HON44R	HD89	HON58R	X214	HU18	AUCS1
HD1	1098GX	HON31AP	HON31AP	HON44R	X173	HON58RDP	HD103-P	HU18	R62WA
HD107-PT5		HON31BP	HD75	HON44RAP	HD89	HON58RT5	HD106-PT5	HU18R	62WA
	HD107-PT5	HON31BPHON	31BP	HON45R	HD88	HON59R	X215	HU18R	AUDS2
HD2R	1003M	HON31P	HD58	HON45R	HD91	HON5R	67LB	HU9	62DP
HD3	1512	HON31P	HD75	HON45R	HD98	HON5R	H76G	HU19	62PD
HD4R	1561	HON31P	HON31P	HON45R	X182	HON5R	HD60	HU19	HR62DP
HD5R	1562	HON31R	X84	HON45RP	HD88-P	HON61RBP	HON61RBP	HU19	OP1D
HD6R	1563	HON31RAP	HD63	HON45RP	HD91-P	HON63FP	X65	HU19	OP60H
HD7R	1564	HON31RAP	HD74	HON45RP	HD98-P	HON64BPHON	64BP	HU19B	H62DP
HEN1	HN2	HON31RAP	HON31RAP	HON46R	HD89	HON64RBP	HON64RBP	HU19R	OP61
HG2	HG3	HON31RBP	HD63	HON46R	HD95	HON66T14HO	03-PT	HU19R	R62DP
HM1	BU4	HON31RBP	HON31RBP	HON46R	X191	HON66T27	HD113-PT	HU1R	S62DW
HM1R	BU4R	HON31RP	HD63	HON46RAP	HD89	HON66T5	O01T5	HU2	BO5
HO2R	HS1	HON31RP	HON31RP	HON46RAP	HD95	HON7	HD4	HU2	LR62VB
HOL1R	1170B	HON32	HD70	HON47	X181	HON7R	HD18	HU2	R62VB
HON1	67J	HON32P	HD70	HON47P	HD83-P	HON8	HD20	HU20	H62VP
HON10	HD8	HON32P	HON32P	HON47P	HD90-P	HON8R	HD19	HU20	O79JB
HON11	HD10	HON33	HD71	HON48	HD86	HOV01T5	HOV01T5	HU20	OP19
HON11R	HD12	HON33P	HD71	HON48	HD94	HRC1	1014C	HU20	U62VP
HON12	HD14	HON34	HD68	HON48	X190	HRD1R	1536R	HU20R	HF21
HON12R	67LC	HON34R	HD65	HON48AP	HD86	HRD2	1529	HU20R	O79JE
HON12R	HD11	HON35	HD67	HON48AP	HD94	HT1	VA2	HU20R	OP1EE
HON13	HD15	HON35R	HD66	HON49	HD70U	HT1R	62H	HU20R	UR62VP
HON13R	HO11	HON37	HD83	HON49	X71	HT2	VA1	HU21	HF10
HON14	HD73	HON37	HD84	HON49P	HD70U-P	HU10	FT1	HU21	O79JC
HON15	HD31	HON37P	HD83-P	HON4R	HD5	HU10	G63Y	HU21	OP11
HON16	HD29	HON37P	HD84-P	HON5	HD13	HU10	R63TY	HU21R	HF11
HON17	HD23	HON38	HD82	HON5	HD61	HU11	FT1L	HU21R	O79JD
HON18	HD33	HON38	X129	HON50	HD42	HU11	HF12	HU21R	OP1DD
HON19	HD35	HON38P	HD82-P	HON50	HD59	HU11	R63Y	HU22	MB15
HON1R	HD24	HON38R	X130	HON51R	X193	HU12	HF15	HU22P	MB15-P
HON1R	HO61P	HON38RP	X130	HON51RP	HD96-P	HU12	HF4	HU23	MB18
HON1R	HO61Q	HON39	HD63	HON52R	HD95	HU12	MB13	HU23P	MB18-P
HON2	67K	HON39	HD74	HON52R	X194	HU12R	HF3	HU24	OP9
HON20	HD34	HON39P	HD63	HON52RP	HD97	SILCA	ILCO	HU25	OP14
HON21	HD32	HON39P	HD69	HON53	HD84	HU12R	HF7	HU25	YM25
HON22	HD30	HON39P	HD74	HON53	X183	HU12R	MB14	HU25R	OP35
HON23	HD45	HON39P	HON39P	HON53	X208	HU13	63W	HU25R	YM27
HON23R	X44					HU13R	R63W	HU26	HF47

CROSS REFERENCE



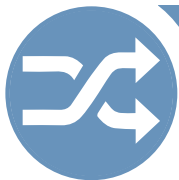

	SILCA	ILCO	SILCA	ILCO	SILCA	ILCO	SILCA	ILCO
	HU50	X144	HYN6P	HY6-P	JS3R	J11	KI9R	SM4
	HU50AP	BMW3-P	HYN7R	X232	JU1	JN58	KIA1R	X233
	HU55P	S34YS-P	HYN7RAP	HY12-P	JU2	JN2	KAI1RAP	KK1-P
SILCA	HU56RP	S60HF-P	IDS1R	IS1	JW1	JU1D	KIA2R	X240
	HF50	S7BW-P	IF1	IF1R	JW1	WA91C	KIA3R	X253
	HU26	S6BW	IF2	IF3S	JW1R	BR91C	KIA3RAP	KK3-P
	HU26	G1	IF3	IF3L	JW4	JU4R	KIA5	X269
	HU26R	VW1	IF4	IF2	JW4R	JU4	KN1R	1557
	HU27	B59	IF4R	IF2R	JW5	JU3	KN2	1565
	HU29	X162	IL1	IG1R	JW5R	JU3R	KO1	63VN
	HU29	S34YS-P	IL1R	IG1	JW6	JU2	KO1	VW63
	HU2R	S34YS-P	ILC1	X1054K	JW6R	JU2R	KO1L	VW63
	HU2R	S58HF-P	ILC10	K1054B	JW7	JU5	KO3	VW63
	HU2R	HU66AT6	ILC11	L1054B	JW7R	JU5R	K1	1063KW
	HU2R	HU66T5	ILC12	1054K	KA1	KAB1	KS1	1063KW-BR
	HU3	HU66T6	ILC13R	X1054GF	KA2	KAB2	KS1	1176
	HU30	R62VA	ILC2	1054MT	KA5	KA5-SI	KS1	S1176
	HU30	Z2	ILC2	X1053	KE3	KE3-SI	KS1FT	S1176
	HU32	G2L	ILC3	1054FN	KE4	S13KE	KS2	A1176
	HU33	L62VA	ILC4R	X1054F	KEI1R	1079B	KW1	KA2
	HU34	LR62VA	ILC5	1054TW	KEI2R	1079	KW1	YH6
	HU34P	ZM91	ILC6	1054UN	KEY1	1635K	KW11	KA13
	HU35	63Y	ILC7	1054DL	KEY1R	1635L	KW12	X103
	HU36	BM1	ILC8	1054	KF1	KFV1	KW12P	KA14
	HU36	HF13	ILC9	1054LB	KI1	61PS	KW13	X103
	HU36P	HU3	IN1	1041H	KI1	S91S	KW13P	KA14
	HU37	1041E	IN10	1043E	KI1	S91W	KW14P	KW14P
	HU37P	HRD3	IN11	1043G	KI10	KM2	KW14R	KW14B
	HU38	X100	IN2	S1042Z	KI10	RC2	KW1R	KA1
	HU39P	HY10R	IN3	S1042ZS	KI10R	KM10	KW3	KA12
	HU4	HY11R	IN4	S1042ZM	KI10R	SM9C	KW4	YH25
	HU40P	X93	IN5	1041W	KI11	64R	KW4R	YH26
	HU41AP	X126	IN7	1043B	KI11	RK4R	KW5	KA5
	HU41P	X127	IN8	1043C	KI11R	RK4	KW6	X41
	HU42P	X101	IN9	10430	KI12	63H	KW6R	X34
	HU43	X102	INS1	D62SA	KI12	PJH	KW7	KA14
	HU43P	X125	INS1	INS1	KI12R	PJE	KW8	KA15
	HU43T2	HYD5	IS1	IGS1	KI12R	R63H	KW8R	KA11
	HU44AP	X95	ISP2	63SP	KI13	KM6	KW9	X106
	HU45P	X94	ISP2	ISP2	KI13	PJP	KW9	X90
	HU46	X96	ISP3	B57	K114	L1TL	KW9R	X105
	HU46	HY6R	HY6R	B57	K115	L1S	KW9R	X91
	HU46P	X97	ISU1	SZ4	KI15R	L1T	LA1	LM2
	HU46T2	X98	ISU3	X158	KI16	L2EX	LA2	LA91S
	HU47	HD51	ISU3P	B57	KI1R	PA91	LA3	LA4
	HU49	HY9	ISU4	SZ3	KI3	KM3	LA3R	LA13
	HU49	X161	ISU5	X275	KI3	PJM	LA4	LA3
	HU49	X235	JC1	1046	KI4	NR63G	LAP1	63L
	HU49AT2	HY13-P	JC2R	1046A	KI4R	N63G	LAP1	DK91F
	HU49BP	X236	JG1R	HH1	KI5	KM5	LAP2	LAP2
	HU49CP	HY14-P	JOW1	JUR62X	K15R	KM7	LAP3	LAP1
	HU49CP	X161	JOW1	R62X	KI6	L3TX	LAP4R	63
	HU49P	X160	JOW1R	JO1	KI7	L3XY	LAP4R	631
	HU49T1	HY2-P	JOW1R	JO91	KI8	PG4	LB10	LS10
	HU5	X187	JOW4R	JO91C	KI8R	PA1	LB11	LS11
	HU5	HY4-P	JOW6	JU2	KI8R	S91WR	LB18	LS18
	HU5	X196	JS1	JI2R	KI9	L63G	LB19	LS19
	HU5	HY5-P	JS1R	JI2	KI9	SM3	LB22	LS22
	HU50	X216	JS3	JI1R	KI9R	LR63G	LB23	LS23





SILCA	ILCO	SILCA	ILCO	SILCA	ILCO	SILCA	ILCO	SILCA	ILCO
LB29	LS29	LMP2	RT19	LW20R	1004R	MAZ1RP	MZ8		
B32	LS32	LMP3	LM3	LW21R	LK21	MAZ2	MZ9		
LB33	LS33	LMP4	NE47	LW23	1004A	MAZ2	X26		
LB34	LS34	LMP5	NE45	LW25	A1015M	MAZ20R	X222	SILCA	ILCO
LB35	LS35	LP11	KS1	LW3	24	MAZ20RGP	MZ27-P	MIT2R	X121
LC1	LC1	LP12	LP27	LW4	4	MAZ24REH	MAZ24R-EKB	MIT2RP	DC3-P
LC1R	LC2	LP12R	LP6	LW4R	4R	MAZ24REH2	MAZ24R-EK	MIT8	X176
LC2	S1096G	LP13	LP1R	LW5	LK1	MAZ24RT5	MAZ24RT5	MIT8-PT	MIT8-PT
LC2R	LC8	LP13R	LP1	LW5R	LK2	MAZ25R	X249	MIT8AP	MIT4-P
LC3	LC5	LP14	LP32R	LW6	LK5	MAZ2P	MZ9-P	MIT8EH	MIT8-EK
LC3R	LC5R	LP14R	LP32	LW7	LK8	MAZ2R	MZ10	MIT8EH2	MIT8-EKB
LC4	LC4	LP15	LP31R	LW8	LK7	MAZ2R	X27	MIT8P	MIT1-P
LC5	LC3	LP15R	LP31	LW9	LK4	MAZ2RP	MZ10-P	MIT8T19	MIT12-PT
LC6	S1096D	LP16	LP30	LYA	999LA	MAZ3	MZ11	MIT9-PT	MIT9-PT
LEG1	62LG	LP16R	LP30R	LYA	Y1LA	MAZ3	X36	MIT9R	FU2
LF1	HR62DG	LP17R	LP5	LYA6	998LA	MAZ4	MZ15	MIW2	MIW2
LF1	LR62DG	LP18R	LP2	LYB	999LB	MAZ5	MZ14	MLM1	MLM1
LF10	X157	LP18R	LPBS	LYB6	998LB	MAZ5	X60	MM1	F91EH
LF10P	LF17	LP19R	LPDS	LYC	999LC	MAZ6	X131	MM1R	F91 FH
LF11	LF1 4	LP2	LP29R	LYC6	998LC	MAZ7	X131	MM2	F91GH
LF12	S1771CR	LP20R	LP26S	LYD	999LD	MAZ7AP	MZ13-P	MM2R	F91 HH
LF13	LF6	LP2R	LP29	LYD6	998LD	MAZ7BP	MZ13	MN6	MG91
LF15R	LF16	LP3	LP7	LYE	999LE	MAZ7BP	MZ13-P	MN6R	MG91R
LF17	LF10	LP36R	LP2	LYE6	998LE	MAZ7R	MZ13R	MON1R	MON1
LF19	LF24	LP38R	LP26	LYF	999LF	MAZ9	MIZ13	MP101	61B
LF2	LF7	LP3R	LP7R	LYF6	998LF	MAZ9R	MZ13R	MP102	B62B
LF20	LF23	LP5	LP24	LYG	999LG	MB1	MB1	MP103	R62B
LF21R	WB3	LP7	LP39	LYG6	998LG	MC1R	MCM1	MP104	62BA
LF21R	X169	LP7R	LP28S	LYH	999LH	MC2	MCM2	MP105	R62BA
LF21RCP	WB3	LP8	R62QB	LYH6	998LH	MC2R	MCM2R	MS1	1092
LF24	LF20	LP8R	LP28	LYK	999LK	MC3	MCM3	MS10	1092DS
LF25	LF20S	LP9	LP21W	LYK	K1LK	MD10R	1517	MS12	MA3
LF26	LF9	LP9R	LP21R	LYK6	998LK	MD4	A1515	MS13R	1092H
LF27	C209	LP9R	LP6	MAZ1	X4	MD6	1542	MS14	1092VR
LF27R	C209R	LR1R	X1014L	MAZ12BP	MIZ16-P	MD7	1515	MS15	MD1054K
LF28R	LF8	LS1	KM8	MAZ13	MZ17	MD9R	A1517	MS16	1092VA
LF3	LF4	LS11	L4RM	MAZ13	X188	MEC1	ME11	MS17	1092-7000
LF3	R81F	LS13	L6S	MAZ13	X201	MER1	ME2	MS18	1092-6000
LF31R	LF18	LS14	L6FM	MAZ13AP	MZ17	MER27	ME7	MS2	1092
LF35	WB2	LS15	PN3	MAZ13BP	MZ17	MER4	ME3	MS3	1092N
LF35	WB3	LS1R	KM9	MAZ13DP	MZ19	MER5	ME1	MS3R	1092NR
LF35P	WB2	LS8	L5CR	MAZ13DP	MZ19-P	MER6	ME6	MS4R	1092VM
LF37	C209L	LS8R	L5RC	MAZ13EP	MAZ13EP	MET1	MO1	MS6	1092D
LF39	C218	LS9	L4A1	MAZ14	MZ20	MG1	MG91C	MS7	1092B
LF3P	BR19	LSA1	1522	MAZ14	X199	MG1R	MG91N	MS8	1092J
LF3P	LF4	LT1	LT1	MAZ15	MZ22	MG2	MG91P	MS9R	1092V
LF4	LF19	LT2	LT3	MAZ15	X200	MG2R	MG91S	MTK1	MTK1
LF4	LF5	LW1	1004N	MAZ17	X178	MIT11R	X224	MTK2P	MTK2P
LF43R	LF25	LW10	LK3	MAZ17AP	MZ16-P	MIT11REH	MIT11R-EKB	MTR1	MR1
LF5	CE3	LW11	LK6	MAZ17BP	MZ16-P	MIT11REH2	MIT11R-EK	MTR2	MR2
LF5	L62FD	LW12R	24B-AUS	MAZ19	MZ25	MIT11RT19	MIT14-PT	MTR3	M64
LF6R	LF1	LW13	24CL	MAZ19	X206	MIT12R	X229	NAS1	1177N
LF9R	WB1	LW14	24A	MAZ19FP	MZ25-P	MIT15AP	MIT15AP	NCR1	X1000FR
LF9RP	WB1	LW15	DL91	MAZ1BP	MZ3	MIT1R	DC1	NCR10	1069LC
LH1	LE1	LW16	RD1	MAZ1BP	MZ4	MIT1R	SZ5	NCR11R	N1069B
LK1R	1180S	LW17	RD2	MAZ1P	MZ7	MIT1R	X54	NCR12	S1069G
LL1	RD4	LW18	GR9	MAZ1R	X5	MIT2	TR33	NCR13	S1069H
LMP1	LM1	LW1R	1004R	MAZ1RBP	MZ2	MIT2P	TR33-P	NCR14	S1069M
LMP1	RT17	LW20	1004	MAZ1RBP	MZ5	MIT2R	DC3	NCR15	1028NR

CROSS REFERENCE

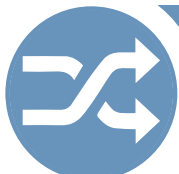

SILCA

ILCO

SILCA	ILCO	SILCA	ILCO	SILCA	ILCO	SILCA	ILCO		
NE23BP	RN24P	NE6P	RE61XR	PB1	PE1	RIQ2	GU91F		
NE23DP	RN24-P	NE7	H63M	PB1P	PE1	RIQ3	GU91G		
NE23EP	RN24	NE7	MB6	PC1	PO1	RIQ4	GU91B		
NE23P	RN24	NE71R	NE71R	P1R	PL2	RIQ4R	GU3		
NCR16R	1069B	NE71RDP	NE71RDP	PD1	PU3	RIQ4R	GU91		
NCR17	1069C	NE75EP	RV4-P	PE1R	1016	RIQ5	S65G		
NCR18	1069E	NE8	H63M	PE2R	1016N	RIQ5R	RS65G		
NCR19	1069G	X12	NE8	MB59	PF070	PR91	RIQ7	LR65G	
NCR1R	X1000F	X30	NE8	NE2	PF071	PR91MS	RIQ7R	L65G	
NCR2	1069	VO73	NE9	NE2	PF072	SIC1	RIQ8	LR65Y	
NCR20	1069-5Y	X29	NE9	VO62	PF073	PR91M	RIQ8R	L65Y	
NCR21	1069-5X	VO73	NE9A	H61VR	PF092S	PR91C	RO1	62Z	
NCR22	1069-5Z	NE40	NE9A	VWIA	PF208	PR91SA	RO1	C2	
NCR23	1065D	63M	NE9B	FTA2R	PF209	PR91NS	RO10	C3	
NCR3	1069G	NE3	RE61N	NF1	PF210	PR91N	RO10	L62UC	
NCR4	R1064E	NE3	RT3	NF1R	PF211	PR91A	RO10	SMS8	
NCR5	1069	NE31	Y16	NH2	1098GM	PR91A	RO10	SMS8	
NCR6	1069N	NE32	NE29	NH2	H1098M	PR91SA	RO11	62U	
NCR7	1069LB	NE33S	NE33	NIO1T	NIO1T	PR91NS	RO11	SM1	
NCR8	1069FL	NE34	NE30	N102T	N102T	PR91L	RO11R	62R	
NCR9	1069M	NE35	NE41	NS1	63VO	PF214	PR91CS	RO11R	SM2
NE1	62BM	NE36	NE43	NS1	P91N	PF4R	PR91S	RO12	63P
NE1	NE1	NE37	NE42	NS3	BM11	PHL1R	A1	RO14	62RS
NE1	Z91	NE38	NE48	NS3	HF26	PJ2	PN1	RO14	SM5
NE10	NE44	NE38AP	NE48	NS4	HF29	PK1	OM10	RO15	H61P
NE10	V80P	NE38CP	NE48	NS4	NS4	POR1	64K	RO15	SM16
NE10	VO6	NE38P	NE48	NSN11	X210	POR1	PO3	RO15R	HR61P
NE11	BM2	NE4	RT3	NSN11	X243	POR2	DM4	RO15R	SM7
NE11	H61N	NE40	VL6	NSN11BP	DA31-P	POR2	VW1CZ	RO1R	C1
NE13	H61VO	NE40	X80	NSN11BP	DA38-P	POR5	KP1	RO1R	R62Z
NE14	H61VM	NE40P	VL6-P	NSN11T2	NSN11T2	POR5	PO4	RO2	61P
NE15	BO3	NE42	NE36	NSN12	DA32	PR1	AU4	RO20	7DC
NE15	BO6	NE42	RN25	NSN12	X227	PR1	DK91A	RO20	PG2
NE15	NE5	NE42	X92	NSN12BP	DA32-P	PR2	DK91E	RO20R	C91
NE16	NE14	NE42AP	NE36	NSN13	DA33	PR2R	DK91C	RO20R	R7DC
NE16	RT7	NE42AP	RN25	NSN13	X228	PR3	DK91B	RO21	HV61
NE17	NE13	NE43	PN2	NSN14	X37	PR3R	DK91J	RO21R	HVR61
NE17	RT6	NE49	NE36	NSN14CP	DA34-P	PR5	A63L	RO22	PJ1
NE18	NE16	NE5	N2M1	NSN14EH		PW1P	PO5-P	RO22R	PJ11
NE18	RT16	NE5	SR61N	NSN14EH		PW2	PO6	RO23	LN1
NE19	X51	NE51	X140	NSN14EH2		PW2P	PO6	RO24	PJ2
NE19AP	AA2	NE51AP	VL8-P	NSN14-EK		PW3	PO7	RO24R	PJ12
NE19P	AA2	NE51P	VL8-P	NSN14T14	N104T	PW3P	PO7	RO26	PJ3
NE2	63JA	NE52DP	NE48	NSN15	X238	PZ1	PZ1	RO27	LN3
NE2	MB9	NE55	X147	NSN16R	X242	PZ2	PZ2	RO28	RT8
NE20	BL11	NE55AP	RN30	NSN16RBP	DA37-P	RB1	1098NR	RO29	NE17
NE20	NE31	NE55DP	RN30	NSN19	X251	RB1	H1098NR	RO2R	R61P
NE20	RE61XR	NE55FP	RN30	NSN4	DT3	RB1	H1098X	RO2R	S91
NE20AP	BL11	NE55P	RN30	NSN4R	DT2	RB2	RN27	RO31	61PC
NE20P	RE61XR	NE57	RN30	NSN8R	SR6	RB2	X150	RO31	S91M
NE21	NE18	NE57	X147	NSN9P	INF90	RB2-OR	1584	RO33	SMS8
NE21	RT10	NE6	NE9	NW1	R1064D	RB2-OR	1970AM	RO34	R15
NE21P	NE18	NE6	RE61XR	NW2R	1064D	RB3	S1970AM	RO4	V61S
NE21P	NE27	NE63	RN31	OAL1	OA91R	RB3-OR	S1970AM	RO4R	VR61S
NE22	Z3H	NE63	X171	OAL1R	OA91	RC2	CNA2	RO5	62UC
NE23	NE26	NE64	X170	OAL2	OA91P	RD2	C219	RO5	C91CV
NE23	NE34	NE64DP	NE48	OAL3	OA91S	RG1	RG1	RO5	C91D
NE23	X116	NE66P	S66NN-P	OAL4R	OA91D	RIC1	RC1	RO50	R16
NE23AP	RN24	NE67AP	S67NN-P	OLT1	ALP9	RIQ1	GU4	RO5R	C91PL
		NE6NP	NE11	OP1	1171P	RIQ1R	GU4R	RO5R	C91R



SILCA	ILCO	SILCA	ILCO	SILCA	ILCO	SILCA	ILCO	SILCA	ILCO
RO5R	R62UC	RW23	A1011-13N	SAR19	1007RDM	SCY3	SY6		
RO6	61PE	RW23.	A1011PR	SAR19R	1007LDM	SCY3R	SY3		
RO7	RN2	RW24R	A1011S	SAR2	L1010N	SCY4	SY8		
RO8	61JD	RW25	1011PZ	SAR20	1007RHM	SCY4R	SY5	SILCA	ILCO
RO8R	R61JD	RW26R	A1011D2	SAR20R	1007LHM	SCY5R	SY9	SK1	FB5
RO9	RN4R	RW27R	A1011D4	SAR21	O1007RA	SCY6	1559	SK11	FB7
RO9	VA91	RW28R	A1011D12	SAR21R	O1007LA	SD1	EX1	SK14	FB1
RO9R	RN4	RW29R	A1011D34	SAR22	O1007RB	SE1	SM6	SK2	FB4
RR1	62HB	RW2R	A1011D1	SAR22R	O1007LB	SE3	SES91	SK22RT1	SK22RT1
RR10R	62HG	RW3	A1011PZ	SAR23	O1007RC	SE3R	SR65	SK3	FB3
RR2	62HA	RW30R	1011D1	SAR23R	O1007LC	SE5	SE91L	SK9	FB6
RR2	BR4	RW31R	1011D2	SAR24	O1007RD	SE7	SEL91	SL1	1022
RR3	62HC	RW32R	1011D3	SAR24R	O1007LD	SE7R	SEL91R	SL2	1022
RR4	62JB	RW33R	1011D4	SAR25	O1007RE	SEA1	SE1B	SM1	SIM2
RR5	X28	RW34R	1011D12	SAR25R	O1007LE	SEA1	SE1C	SM11	S91P
RR6	62HD	RW35R	1011D34	SAR26	O1007RF	SEA3	F54	SM14R	S91R
RR7R	62HF	RW36R	1011D41	SAR26R	O1007LF	SF3	X64	SM1R	D1098BM3
RR8R	62HG	RW37	1011PZ	SAR27	O1007RG	SF4	X79	SM1R	SM1R
RT1	X16	RW38R	1012	SAR27R	O1007LG	SF5	SP8	SM2	S91A
RT1P	P1771CR	RW39	1011GH	SAR28	O1007RH	SG808	SHA1	SM3	S91BV
RT2	CE5	RW3R	A1011PZR	SAR28R	O1007LH	SH1	1307A	SM4	S91CV
RT2	LF15	RW4	A1011-3N	SAR29	O1007RJ	SH10	A1145E	SM5	S91K
RT2	X50	RW4	A1011PC	SAR29R	O1007LJ	SH11	1145E	SM6	SIM1
RT2P	AA3	RW40R	1011M	SAR3	N1007RMA	SH12	1145G	SM8	SIM8
RU1	RK1	RW41R	A1011M	SAR30	O1007RK	SH13	1145H	SM9R	SIM9R
RU2	R67P	RW42R	A1011S	SAR30R	O1007LK	SH14	1145J	SNW2	S2-AUS
RU2R	67P	RW43R	N1011M	SAR31	O1007RL	SH15	1145K	SNW3	S4-AUS
RU3	67Q	RW5R	A1011D41	SAR31R	O1007LL	SH16	1145L	SO4	SOS91
RU3R	R67Q	RW6R	1011D1	SAR32	O1007RM	SH17	1145CE	SO5	S091P
RU4	67N	RW7R	1011	SAR32R	O1007LM	SH18	1145FG	SO6	SOS1
RU4R	R67N	RW8R	1001P	SAR33	O1007RDH	SH19	A1145G	SO7	R65S
RU5	67U	RW8R	1001P	SAR33R	O1007LDH	SH2	1307W	SOL8A1	BD1A
RU5R	RK3	RW9R	A1011P	SAR34	O1007RDM	SH20	A1145H	SOL8A2	BD2A
RU7	RU91C	RX1	RX2	SAR34R	O1007LDM	SH21	A1145J	SOL8A3	BD3A
RW10R	N1011P	RX2	RX1	SAR35	O1007RHM	SH22	AI 145K	SOL8A4	BD4A
RW11	A1011-1N	SA1	170S	SAR35R	O1007LHM	SH23	A1145CE	SOL8A5	BD5A
RW11	A1011PD	SA2	70S	SAR36R	1009	SH24	A1145FG	SOL8B1	BD1B
RW12	A1011-2N	SAN1R	SN1	SAR37	O1010	SH27	SC1247	SOL8B2	BD2B
RW12	A1011PK	SAR1	1010N	SAR38R	O1007CE	SH3	1145	SOL8B3	BD3B
RW13R	N1011S	SAR10	1007RF	SAR39R	O1007CA	SH4	A1145L	SOL8B4	BD4B
RW14	A1011-4N	SAR1031	1028D	SAR3R	N1007KMA	SH5	1145A	SOL8B5	BD5B
RW14	A1011PE	SAR1032	1068E	SAR40	1010	SH5	A1145C	SOL8C1	BD1C
RW15	A1011-5N	SAR10R	1007LF	SAR42	O1009	SH6	A1145EF	SOL8C2	BD2C
RW15	A1011B	SAR11	1007RG	SAR5	1007RA	SH7	A1145F	SOL8C3	BD3C
RW16	A1011-6N	SAR11R	1007LG	SAR5R	1007LA	SH8	1145EF	SOL8C4	BD4C
RW16	A1011PF	SAR12	1007RH	SAR6	1007RB	SH9	1145F	SOL8C5	BD5C
RW17	A1011-7N	SAR12B	1007LH	SAR6R	1007LB	SHW1	62SH	SOL8D1	BD1D
RW17	A1011PG	SAR13	1007RJ	SAR7	1007RC	SIL1R	SIL1R	SOL8D2	BD2D
RW18	A1011-8N	SAR13R	1007LJ	SAR7R	1007LC	SIP1	NE9	SOL8D3	BD3D
RW18	A1011 PH	SAR14	1007RK	SAR8	1007RD	SIP11	ET43	SOL8D4	BD4D
RW19	A1011-9N	SAR14R	1007LK	SAR8R	1007LD	SIP14	IV1	SOL8D5	BD5D
RW19	A1011PJ	SAR15	1007RL	SAR9	1007RE	SIP14P	IV1	SP1	VW1CZ
RW1R	A1011D3	SAR15R	1007LL	SAR9R	1007LE	SIP2	F44	SPU1R	SPU1R
RW20	A1011-10N	SAR16	1007RM	SC1	SC1	SIP2	X109	SQ1	192
RW20	A1011PL	SAR16R	1007LM	SC2	STA2	SIP2AP	F44	SQ2	1192B
RW21	A1011-11N	SAR17	N1007RMB	SCY1	SY4	SIP2AP	NE23	SQ2	192B
RW21	A1011PM	SAR17R	N1007KMB	SCY1R	SY1	SIP2P	NE19	SR1	SU9
RW22	A1011-12N	SAR18	1007RDH	SCY2	SY2	SIP2P	SP9	SR2	SU9S
RW22	A1011PN	SAR18R	1007LDH	SCY2R	SY7	SIP3	NE13	SR2	SX1

CROSS REFERENCE



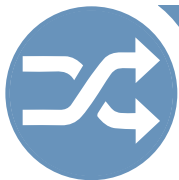

CROSS REFERENCE

SEC 10 PG 448

SILCA

SR4 SR7 SR8 SRN1R SS10 ST1 STR1 STR1 STR1 STR2 STR3 STR4 STR4R SV1 SV1R SV2R SW1R SW2 SW3 SWL1 SX1 SX1 SX3 SX3 SX4 SY1 SY2R SZ1 SZ10R SZ10R SZ10RP SZ10RP SZ11R SZ11R SZ11RP SZ12 SZ12 SZ12P SZ1R SZ2 SZ2R SZ3 SZ4 SZ4 SZ4P SZ4P SZ4P SZ4R SZ4R SZ4RP SZ5 SZ5P SZ8RP SZ9 SZ9P

ILCO

SU9L SX3 SX4 50 1523 SCH1 BR17 SR3 SR4 SR5 SR1 SR2 ST91F ST91V SV3 SW2 SW1 SW3 1568 C6 SM2 C17 VC30 VC31 1120D 1120F SUZ2 SUZ12 X179 SUZ12 TO8X2 SUZ17 X186 SUZ17-P SUZ15 SUZ15-P SUZ1 SUZ3 SUZ4 SUZ5 HD57 SUZ10 HD57 SUZIO SZ4P HD56 SZ4R SZ4RP X87 SZ5P SZ8RP SZ9 SZ9P

TB1 TB1R TBE1P TBE1T5 TBE2P TE1 TE1R TE2 TE3 TH1 TK1 TK1R TK2 TK2R TK3 TK3R TK4 TK4R TK5R TL6 TN3 TN5 TO1 TO10 T03 T04 TO8X1 TO8X10 TO8X12 TO8X13 TO8X14 TO8X15 TO8X16 TO8X17 TO8X18 TO8X2 TO8X3 TO8X4 TO8X5 TO8X7 TO9Y1 TO9Y10 TO9Y11 TO9Y12 TO9Y13 TO9Y14 TO9Y16 TO9Y17 TO9Y18 TO9Y2 TO9Y3 TO9Y4 TO9Y5 TO9Y6 TO9Y7 TOY1 TOY10 TOY10R TOY11

DB1 DB2 S32FJ-P TBE1T5 S33FJ-P TE1 TE2 TE4 TE3 1148 66E R66E ER10 ER3 ER6 ER5 ER9 ER8 VL1 TRI5D TT1 TT91 TO91 TK41 TK3 TK4 TK13 TK15 TK16 TK17 TK18 TK19 TK20 TK21 TK5 TK6 TK7 TK8 TK10 TK22 TK31 TK32 TK33 TK34 TK35 TK37 TK38 TK39 TK23 TK24 TK25 TK26 TK27 TK28 TA2 TA11 TA16 TR28

TOY11 TOY11BP TOY12 TOY13 TOY13 TOY14 TOY15 TOY16 TOY17 TOY18 TOY18P TOY18P TOY19 TOY19 TOY1R TOY2 TOY26 TOY26P TOY27R TOY27RP TOY28 TOY28P TOY29R TOY29RP TOY2R TOY3 TOY3 TOY30 TOY30 TOY30P TOY32R TOY32RP TOY34R TOY34R TOY35R TOY38R TOY38RP TOY39R TOY39R TOY3R TOY3R TOY3R TOY4 TOY4 TOY40AP TOY40BT4 TOY40P LXP90-P TOY41R TOY41RAT4 TOY41RAT4 TOY41RP TOY42 TOY42P TOY43 TOY43AT4 TOY43AT4 TOY43EH TOY43-EKB TOY43EH2 TOY43-EK2 TOY43P TR47-P TOY44

X37 TR28-P TA21 TA26 TA25 TOY13 TR18 TA15 TA23 TA24 TA25 TR25 1519 MS13 TA12 TA5 X159 TR28-P X137 TR33-P TR37 TR28-P TR33 TR33-P TA4 T61A TA14 TR39 X151 TR39 TR25 T61C UL050 UL051 TR25 UL052 X174 TR40-P TA21 TR49 MS2 T61B TA1 T61C T61G LXV90-P TOY40BT4 LXP90-P X211 TOY41RAT4 TR44-P X212 TR46-P X217 TOY43AT4 TOY43AT4 TOY43EH TOY43-EKB TR47-P X220

TOY45R TOY46R TOY46RP TOY48EH TOY48EH2 TOY4BP TOY4R TOY4RBP TOY4RBP TOY4RCP TOY5 TOY5 TOY5 TOY5-PT TOY5P TOY6 TOY7 TOY8 TOY9 TR1 TR11R TR14 TR15 TR2 TR3 TR4 TR8 TTL1 TTL2 TY1 TY2 TY3 UC2 UL050 UL051 UL052 UM1R UNI1 UNI1 UNI1 UNI10 UNI11 UNI11A UNI11A UNI12 UNI13 UNI13 UNI13 LXP90-P X211 UNI14 UNI14 UNI15 UNI16 UNI16 UNI16R UNI17 UNI17 UNI18 UNI19 UNI19

X219 X223 TR53-P TOY48-EKB TOY48-EK2 T61C-P 1771CT DC1-P T61C-P T61C P1098V T61F T80H TOY57-PT P1098V T61D TA19 TR26 X46 TO1 TO11R TO4 TO3 TO2 TO5 TO6 TO8 A1176T A1176ST 1141GE 1141 H1122M UCM1 WA91WL WA91L WA91W WA91 UM2 62DH BR10 BR3 62DP B62DP 62FS F70T S62DP BR16 70S 62DM B62DR S62DR BR18 H62DR BR18R 62DK BR8 UN1 BR20 CE4

UNI19 UNI19P UNI2 UNI20 UNI23 UNI24 UNI24 UNI25 UNI27 UNI28 UNI28 UNI29 UNI2R UNI2R UNI2R UNI3 UNI3 UNI30 UNI33 UNI33R UNI34 UNI34R UNI35 UNI35R UNI36 UNI36R UNI37 UNI37R UNI38 UNI38R UNI39 UNI39R UNI4 UNI4 UNI40 UNI40R UNI41 UNI41R UNI42 UNI44 UNI44R UNI45 UNI45R UNI46 UNI46R UNI47 UNI47R UNI48 UNI48R UNI49 UNI49R UNI4R UNI4R UNI5 UNI5 UNI50 UNI51 UNI51R

MG1 MG1 62DG UN16 62DA 62DE BR14 62DJ UN5 1033 U180G L62DM HR62DG R62DG S91RM 1033N 33NO S33P UN51 UN61 UN52 UN52 UN50 UN60 UN58 UN68 UN53 UN63 UN54 UN64 UN57 UN67 62DM BR11 UN56 UN66 UN59 UN69 MG1 UN51L UN61L UN52L UN62L UN50L UN60L UN58L UN68L UN53L UN63L UN54L UN64L R62DH R62DM 62DO BR12 UN59L UN69L UN56L UN66L



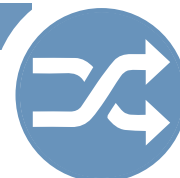

SILCA	ILCO	SILCA	ILCO	SILCA	ILCO	SILCA	ILCO	SILCA	ILCO
UNI52	UN57L	VAC47	H62BM	VO7	VW20	WH2	1071A		
UNI52R	UN67L	VAC5	VAT1	VO8	62VS	WH3	1071B		
UNI53	62DB	VAC57	H62CM	VO8	A81N	WH4R	1071BM		
UNI56R	S33C	VAC58	H62DM	VO8	U62VN	WH5R	1071D	SILCA	ILCO
UNI6	62DN	VAC59	NE46	VO9	73VB	WH6R	1071E	XPZ2	XPA2
UNI6	BR9	VAC59	RN29	VO9	X9	WH7R	1071M	Y160-PT	Y160-PT
UNI6	UN16	VAC59	X122	VO9AP	73VB-P	WI2	VW64T	Y162-PT	Y162-PT
UNI7	H62DP	VAC59P	RN29	VO9BP	73VB-P	WI3	VW3	Y164-PT	Y164-PT
UNI8	62FT	VAC6	H7RDH	VO9P	73VB-P	WI3	W62VE	YA1	999
UR1	UR3	VAC62	PG5	VYA	999VA	WI3	WT2	YA1	X999
UR1R	UR3R	VAC62	X148	VYA	BVA1	WK1	W91C	YA10	1767CH
UR2R	UR2	VAC8	V91E	VYA6	998VA	WK10	WIL1	YA10	D1707K
VAC1	VAE1	VC1	VEC2	VYB	999VB	WK11	WK10	YA11	S1767CH
VAC1O	VC21	VC1R	VEC1	VYB6	998VB	WK2	WK7	YA12	D1759L
VAC102T1	VAC102T1	VE1	VE4	VYC	999VC	WK25	WK15	YA12	S1767DP
VAC11	V1S	VEG1	VG2	VYC6	998VC	WK25R	WK16	YA13	H997EB
VAC12	63PX	VG1	VG1	VYD	999VD	WK26	WK12	YA14	HR1132
VAC12	V91P	VI080	VR91	VYD6	999VD	WK27	WK32	YA14R	1132
VAC12P	63PX	VI081	VR91R	VYE	999VE	WK28	WK23	YA14R	H1132
VAC14	VC22	VI082	VR91S	VYE6	998VE	WK29	WK20	YA15	YL5
VAC15	H7RA	VI083	SR191A	VYF6	998VF	WK3	WK3	YA16	997GX
VAC15R	H7LA	VI084	VR91B	VYG	999VG	WK30	WK29	YA16L	997G
VAC16	H7RB	VI085	VR91BR	VYG6	998VG	WK31	WK25	YA16R	997GXR
VSAC16R	H7LB	VI086	VR91AR	VYH	999VH	WK32	WK19	YA16RL	997GR
VAC17	H7RC	VI087	VR91A	VYH6	998VH	WK33	WK18	YA17	F1122A
VAC18	H7RD	VI088	VR91CR	VYK6	998VK	WK34	WK22	YA17	H1122F
VAC18R	H7LD	VI089	VR91C	WA1	WA91WL	WK35	WK24	YA17R	F1122AR
VAC19	V91LE	VI1	VR1R	WA1R	WA91L	WK36	WK27	YA17R	H1122FR
VAC19N	H7RE	VI1R	VR1	WA2	WA91W	WK37	WK21	YA17R	O1122AR
VAC2	H10F	VO1	VW71A	WA2R	WA91	WK38	WK28	YA18	C1041P
VAC20	V91LF	VO10	VW71	WA4	WA91PR	WK39	WK30	YA19	E1122A
VAC20N	H7RF	VO10P	VW71	WA4R	AW91P	WK5	WK26	YA1E	999
VAC20RN	H7LF	VO10P	VW71V	WAS1	DA20	WK6	WK17	YA1R	999R
VAC21	V91LG	VO11	VW71A	WAS13RAP	X177	WK6R	WK14	YA1R	X999R
VAC21N	H7RG	VO11P	VW71A	WAS13RP	JA2	WK7	WK13	YA2	998
VAC21RN	H7LG	V013	V33	WAS2	WS2	WR1	TS1	YA2	998GL
VAC22	V91LH	V013	X110	WAS2R	WS4	WR4	WRE2	YA20	YL5
VAC22N	H7RH	V013P	V33	WAS3	WS3	WS1	1175N	YA226	14KH
VAC22RN	H7LH	V02	FT3F	WAS3R	WS1	WS2	1175N	YA227	H999R
VAC23	H7RDH	V02	VW63A	WAS4	DO5	WS3	1175	YA28	1764P
VAC23R	H7LDH	V02R	FT3	WAS4	DO7	WST3	WST3	YA28	1769CH
VAC24	C7	VO3	61VW	WAS4	WS10	WT10	V35	YA28	1770CH
VAC24	VC24	VO3	62DW	WAS4	WS5	WT10	X139	YA28	P1770U
VAC25	VC28	VO3	62VW	WAS5	WS11	WT10P	V35-P	YA28-OR	P1770U
VAC25R	VC34	VO3	S62DW	WB2	NL1	WT4	PA5	YA29	999B
VAC26	VC25	VO3	W62VB	WB2	WAR4	WT5	AU12	YA2R	998R
VAC27	C8	VO4	HF35	WB2R	WAR3	WT5	WT5	YA3	997D
VAC27	VC26	VO4	VW77	WC1	WO1	WT6	PA6	YA3	997E
VAC28	C16	VO4R	V27	WC2	WO2	WT7	PA8	YA3	KS91P
VAC28	VC27	VO4R	VW67	WC3	WO3	WT7	X88	YA3	Y200
VAC29	V91N	VO4RP	V27	WE11	1054WB	WT7AP	73VB-P	YA3	YL9
VAC3	H62KB	VO4RP	V67	WE11	N1054WB	WT7AP	PA8-P	YA30	YL6
VAC30	VCA1	VO4RP	VW67	WE110	X1054WA	WT7AP	X88	YA31	14KH
VAC30R	VCA1R	VO5	VW67S	WE12	A1054WB	WT7BP	PA8-P	YA32	997A
VAC32	H7LDH	VO5P	VW67S	WE14	A1054WC	WT7P	PA8-P	YA32	O997E
VAC33	VC32	VO6	HR62VK	WE15	1054WC	WT9	73VB	YA34	999N
VAC33R	VC33	VO6	U61VW	WE15	N1054WB	WT9	PA8	YA35	999N
VAC35	RT18	VO6R	H62VK	WEL1	1123	XOM1	138	YA36	999
VAC35	VC29	VO6R	V61VW	WH1	1071	XPZ1	XPA1	YA36R	999R

CROSS REFERENCE



SILCA	ILCO	SILCA	ILCO	STAR	ILCO	STAR	ILCO	STAR	ILCO
ZE31-42	ZK6	ZE31-92	ZK60	5EA1	1014F	5RU7	1011D1		
ZE31-43	ZK7	ZE31-93	ZK61	5EA1	X1014F	5RU8	1011D41		
ZE31-44	ZK8	ZE31-94	ZK62	5EA2	1014	5RU9	N1011M		
ZE31-45	ZK9	ZE31-95	ZK63	5EL1	1096L	5SA1	O1010	STAR	ILCO
ZE31-46	ZK10	ZE31-96	ZK64	5EL2	1096	5SA1	1010U	6CO16	A1001CDM
ZE31-47	ZK11	ZEM -97	ZK65	5EL3	C1096LN	5SA10	1007LC	6CO2	1001EA
ZE31-48	ZK12	ZE31-98	ZK66	5EL4	C1096CN	5SA2	1009	6CO3	1000AB
ZE31-49	ZK13	ZE31-98A	ZK67	5ER1	1119	5SA3	N1007KMB	6CO5	R1001EG
ZE31-5	60Z5	ZE31-98B	ZK68	5ES1	1503	5SA4	1007	6CO6	1000F
ZE31-50	ZK14	ZE31-98C	ZK69	5EX99	EX1	5SA5	1010	6DE1	A1054KD
ZEM -51	ZK15	ZE3R	Z91KR	5FR1	1073K	5SA6	N1007RMB	6DE3	D1054KA
ZE31-52	ZK16	ZE4	ZK1	5FT1	F44	5SA7	1010N	6EA2	1014A
ZE31-53	ZK17	ZE5	Z91K	5HD1	1125	5SA9	1007LB	6EL4	L1096CN
ZE31-54	ZK18	ZE5R	Z91KR	5HL1	HL3	5SA-LA	S22 1/2	6IL2	X1054KF
ZE31-55	ZK19	ZE6	ZMK2	5HO1	1170	5SE1	1022	6JU2	1046A
ZE31-56	ZK20	ZE6R	ZMK1	5HO1	1170B	5SE2	O1022	6KW1	A1176
ZE31-57	ZK21	ZN1	ZN1	5HR1	1014C	5SH1	1145	6LO1	1004A
ZE31-58	ZK22	STAR	STAR	5HR2	TE3	5SH3	1145L	6MA8	1092J
ZE31-59	ZK23	STAR	ILCO	5HU1	1020	5SH4	1145E	6NW1	1017BA
ZE31-6	60Z6	4EA1	1014K	5IL1	1054F	5SH5	1145F	6NW2	O1017ML
ZE31-60	ZK24	4EA4	1014DX	5IL11	1054MT	5SH7	1145G	6RE1	1019A
ZE31-61	ZK25	4ER1	1119S	5IL2	1054K	5SN1	1177	6RU2	A1011P
ZE31-62	ZK26	4MA2	1092B	5IL3	1054	5SQ1	192	6RU5	A1011PZ
ZE31-63	ZK27	4MA7	1092DS	5IL4	X1054K	5TA1	1141	6RU7	A1011D1
ZE31-64	ZK28	4RO2	1064	5IL6	1004M	5TA2	1141E	6RU8	A1011D41
ZE31-65	ZK29	4YA1	999B	5IL7	X1054F	5TA4	1141GE	6RU9	A1011M
ZE31-66	ZK30	4YA15	S7JA	5IL8	X1054JA	5TA5	1141F	6SA3	N1007KMA
ZE31-67	ZK31	4YA6	997X	5IL9	1054FN	5UN1	1033N	6SA6	N1007RMA
ZE31-68	ZK32	5AM1	1045	5JU2	1046	5VR1	VR91	6SA7	L1010N
ZE31-68A	ZK33	5AR2	1179	5KE1	1079B	5VR2	VR91R	6SA-LA	S22
ZE31-68B	ZK34	5AU1	1003M	5KE2	1079	5VR3	VR91AR	6SE1	1022AB
ZE31-68C	ZK35	5AU2	1069LB	5KW1	1176	5VR4	VR91B	6SE2	O1022AB
ZE31-7	60Z7	5BE1	1114	5L01	1004	5WE1	1123	6SE4	1022H
ZE31-70A	ZK36	5BO1	R1003M	5MA3	1092V	5W11	1071	6SE5	R1022L
ZE31-70B	ZK37	5CG4	1041Y	5MA4	1092VM	5WK1	1175	6SH1	1145A
ZE31-70C	ZK38	5CG5	1041E	5MA5	1092N	5WK1	1175N	6SH3	A1145L
ZE31-71	ZK39	5CG7	C1041C	5MA6	1092H	5WR1	X1054WA	6SH4	A1145E
ZE31-72	ZK40	5CH1	1015C	5MA7	1092D	5WR2	1054WB	6SH5	A1145F
ZE31-73	ZK41	5CH2	1015M	5NA1	1177N	5WR2N	L1054WB	6SH7	A1145G
ZE31-74	ZK42	5CH3	1015	5NW1	1017B	5YA1	999	6VL1	VO6
ZE31-75	ZK43	5CL1	1023	5NW3	1017	5YA11	996M	6WR2	A1054WB
ZE31-76	ZK44	5CO1	1001EN	5PE1	1016N	5YA13	999R	6YA1	999A
ZE31-77	ZK45	5CO11	1001EH	5PE2	1016	5YA1E	999N	6YA12	998GA
ZE31-78	ZK46	5CO12	1001ABM	5PO1	1034	5YA2	C999	6YA14	998YMK
ZE31-79	ZK47	5CO13	1001GH	5PO2	1034H	5YA6	997E	6YA3	998
ZE31-8	60Z8	5CO2	1001EB	5PR1	SC1176	6AL1	ALP4	6YA6	O997E
ZE31-80	ZK48	5CO3	1000	5RE1	1019	6AM1	A1045	6YA7	998R
ZE31-81	ZK49	5CO4	1001	5RE2	1019D	6AR2	1179A	6YA8	998GST
ZE31-82	ZK50	5CO5	R1001EN	5RO4	R1064D	6AR3	A1019M	6YA9	J997M
ZE31-83	ZK51	5CO6	1000G	5RO4N	R1064E	6BE1	A1114A	7BE2W	A1114FM
ZE31-84	ZK52	5CO8	X1001KC	5RP2	X12	6BE2	A1114M	7CH2	L1015M
ZE31-85	ZK53	5CO9	R1001EF	5RP3	X116	6CH2	A1015M	7CH4	L1015MR
ZE31-86	ZK54	5DA1	DA20	5RS1	1140G	6CH4	A1015MR	7CO1	1001EL
ZE31-87	ZK55	5DA2	X1	5RU1	1011	6CO1	1001EG	7CO11	L1001EH
ZE31-88	ZK56	5DE1	1054KD	5RU2	1011P	6CO10	X1000F	7CO12	L1001ABM
ZE31-89	ZK57	5DE3	D1054K	5RU3	X1000KR	6CO11	A1001EH	7CO16	L1001CDM
ZE31-9	60Z9	5DO1	L1054F	5RU4	1011M	6CO12	A1001ABM	7CO2	1001E
ZE31-90	ZK58	5DO3	L54K	5RU5	1011PZ	6CO14	1000FR	7CO5	R1001EL
ZE31-91	ZK59	5DO4	P54F	5RU6	1012	6CO014	X1000FR	7IL2	1004KL

CROSS REFERENCE



CROSS REFERENCE

STAR

ILCO

STAR	ILCO	STAR	ILCO	STAR	ILCO	TAYLOR	ILCO
HBR10J	P1098J	LU1	T61F	UN3	62FS	62	1069
HBR11	1970AM	LYJ1	L1122A	UN4	MG1	63	63
HBR12A	P1098A	M6000	1092-6000	VW1	62VW	64	1064
HBR14C	P1098C	M7000	1092-7000	VW2	VW67	66	1015C
HBR15A	P1098AV	MA1	1092	VW3	VW71	68	1016
HBR15C	P1098CV	MI1	X176	VW4	X9	71	1071
HBR15E	P1098EV	MIZ1	X26	VW5	VW71A	72	1017
HBR2	H1098LA	MZ13	X131	YA10	1132	75	1019
HBR3	H1098NR	MZ2	X27	YJ1	O1122A	77	1047CR
HBR5	H1098A	MZ3	X36	YJ2	O1122AR	78	1068
HBR7	H1098C	MZ4	X4	YJ3	O1122	79	1079
HBR9E	P1098E	MZ5	X5	YJ4	O1122B	80	1080
HD103	X214	OBR1	1098M	YJ5	O1122R	92	1092
HFD1	1127	OBR10K	S1098K	STRATTEC		96	1096
HF10	1167FD	OBR11	S1970AM	STRATTEC	ILCO	102	1022
HF11	1185FD	OBR12B	S1098B	4225455	B116	111	1141A
HFD12L	1184FD	OBR14D	S1098D	4225455	B119	118	1118
HFD2	1125K	OBR1DB	1098DB	598333	H82M-PT	119	1119
HFD3	1127D	OBR2	O1098LA	692246	HD106-PT	123	1023
HFD4	1127DP	OBR3	1098NR	692352	Y164- PT	125	1125
HFD5	1127MP	OBR4	L1098LA	692353	Y165-PT	127	1127
HFD6	1127DU	OBR5	O1098B	692383	B115-PT	132	1132
HFD62	1191ET	OBR7	O1098D	692562	MITI6A-PT	133	1123
HFD67	1193FD	OBR9H	S1098H	692931	B111-GCPT	135	1179
HFD7	1125H	OFD10	S1167FD	5907552	HO03-PT	136	757
HFD70	X231	OFD2	1125M	5907793	MIT12-PT	137	1137S
HFD8	1127T	OFD4	1127ES	5909874	Y170-PT	138	138
HFD9	1127FD	OFD6	M1127A	5910834	TOY44D-PT	140	1140
HN1	X51	OFD9	S1127FD	5912114	B112-PT	143	1143
HN2-3	HD70	OPL1	XO1199G	5912557	MIT17A-PT	145	1145
HN4	X44	OPL2	XO1199B	7003526	N104T	147	SC1247
HN5	X84	OPL4	D1759L	7011685	B1114R-PT	170	1170B
HN6	X129	OPL5	1759P	7011685	B111-PT	171	1171
HN90	X181	OPL68	S1768CH	TAYLOR		172	1171B
HN95	X191	OPL8	1766S	TAYLOR	ILCO	175	1175
HN98	X195	RO1	1069	14	999	181	170S1
HPL1	X1199G	R03	1069FL	20	1000	182	D1098X
HPL2	X1199B	R05	1069G	23	1001	183	D1098B
HPL3	X1199J	R06	1069N	26.5	VA2	184	62TA
HPL6	1706K	RP1	RE61N	31	1131	502	3B
HPL68	1768CH	SAT91	P1108	35	1004	502	2B
HPL73	1769CH	SH2	1307A	38	1006	502	49B
STAR	ILCO	SH6	1307W	40	1040	503	7B
DA5	X123	STAR	ILCO	41	C1041R	504	504
DA6	DA23	HPL89	P1789	42	1042B	505	B6
DA7	X114	HY5	X196	43	1007	506	506
DE2	D1098X	HYA4	X1199A	44	1042A	507	5B
EA3	1014J	HYA5	X1199AR	45	1041W	508	9B
EA5	1014JS	IL10UN	1054UN	46	1008	509	17B
EA6	O1014S	IL5	L1054B	47	L1042B	511	19B
FT2	FT38	IS1	1041H	48	A1008	520	90B
FT3	FT37	IS2	1043B	49	1010	521	91B
GM64C	P1098WC	IS3	1043D	50	10108	525	14B
GM67D	S1098WD	JU1	1041C	51	10108	525	14B
GM68	P1099	KWT	A1176ST	52	10108	525	14B
GM78E	P1098WE	LC015	1000T	53	S1010B	530	8B
GM79H	S1098WH	LC07	1000V	54	1054	533	68M
GM86	P1106	LDC1	X54	55	1011	536	66B
GM89	P1107	LTO1	X137	56	1012	539	1B
HBR1	H1098M	LU1	P1098V	60	1013	544	73M
				61	1014	548	54M



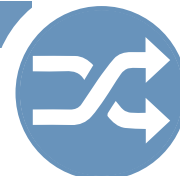

TAYLOR	ILCO	1 TAYLOR	ILCO	TAYLOR	ILCO	TAYLOR	ILCO	TAYLOR	ILCO
549	14CM	2LM	998GL	137B	1137B	183M	D1098BM		
550	71B	12PA	998PA	137S	1136S	183T	TE1I		
553	B5A	12PB	998PB	13GM	998A	184B	62TC		
574	178SB	12PC	998PC	140B	1140G	184C	L62TC	TAYLOR	ILCO
628	62B	12PD	998PD	145A	1145A	184G	GL1	22HM	1001CDM
637	21B	12PE	998PE	145CE	A1145CE	184GS	GL3	22R1	1003A
640	22M	12PF	998PF	145E	A1145E	184K	184K	22R12	1003AB
642	22BB	12PG	998PG	145EF	A1145EF	185V	185V	22R14	1003M
643	23B	12PH	998PH	145ES	1145E	185VS	VR91AR	22R2	10038
644	23M	12PK	998PK	145F	A1145F	191B	VR91B	22R3	1003C
646	84B	12SA	998SA	145FG	A1145FG	191C	VR91CR	22R34	1003CD
651	27B	12SB	998SB	145FS	1145F	20A	1000A	22R4	1003D
652	34B	12SC	998SC	145G	A1145G	20AB	1000AB	22VL	XO1000GR
669	669	12SD	998SD	145GS	1145G	20BP	1000P	22Z2	1001EH
102AB	1022AB	12SE	998SE	145H	A1145H	20BPS	S1001JB	23K	1001K
102E	O1022E	12SF	998SF	145HS	1145H	20F	1000F	23R1	L1003A
111A	TY1	12SG	998SG	145J	A1145J	20FR	1000FR	23R12	L1003AB
111B	1141K	12SH	998SH	145JS	1145J	20FX	1000FX	23R14	L1003M
111E	1141E	12SK	998SK	145K	A1145K	20G	1000G	23R2	L1000B
111GE	1141GE	12SM	998SMK	145KS	1145K	20H	1000H	23R3	L1000C
111GS	1141GS	12TA	998TA	145L	A1145L	20HL	1000HL	23R34	L1003CD
111JL	1141JL	12TB	998TB	145LS	1145L	20K	1000K	23R4	L1003D
111K	1141F	12TC	998TC	14A	999A	20KC	1000KC	24WL	1001WL
111L	1141	12TD	998TD	14EN	999T	20KS	S1000X	26E	VA1
111TS	1141H	12TE	998TE	14GA	999GA	20KT	1000X	28N	1028NN
111W	1141W	12TF	998TF	14GB	999GB	20T	1000T	307A	1307A
119S	1119S	12TG	998TG	14GC	999GC	20TS	S1000T	307W	1307W
120D	1120D	12TH	998TH	14GD	999GD	20V	1000V	31R	1131R
120F	1120F	12TK	998TK	14GE	999GE	20VS	S1000V	35A	1004A
120G	1120H	12TM	998TMK	14GF	999GF	20WX	1000XK	35AL	1004AL
120H	1120G	12VA	998VA	14GG	999GG	21A	1001EA	35K	1004K
121B	1021B	12VB	998VB	14GH	999GH	21CR	1001CR	35M	1004M
121BA	1021BA	12VC	998VC	14GK	999GK	21E	1001E	35N	1004N
123A	1023A	12VD	998VD	14GM	998S	21EB	1001EB	35RA	1004AR
125G	1125G	12VE	998VE	14H	H999R	21EG	1001EG	40A	1040A
125H	1125H	12VF	998VF	14K	14K	21EL	1001EL	40B	1040B
127DP	1127DP	12VG	998VG	14KH	14KH	21EN	1001EN	40C	1040C
127ES	1127ES	12VH	998VH	14KR	14KR	21R1	S1003A	40E	1040E
128L	1127T	12VK	998VK	14R	999R	21R12	S1003AB	40F	OM10
12GA	998GA	12VM	998R	14YM	C999	21R 4	S1003M	41B	1041B
12GB	998GB	133S	1123S	170A	A1170B	21R2	S1003B	41C	1041C
12GC	998GC	135A	1179A	170CB	1170BD	21R3	S1003C	41CM	1041CE
12GD	998GD	135D	755	170M	1170M	21R34	S1003CD	41CO	1041CK
12GE	998GE	135E	A1179E	171P	1171P	21R4	S1003D	41DB	1041DB
12GF	998GF	135F	A1179F	174B	1069L	22A1	1001AH	41DC	1041DC
12GG	998GG	135G	A1179G	174BA	1069LB	22A2	1001FH	41DE	1041DH
12GH	998GH	135H	A1179H	174BN	1069LA	22AM	1001AM	41DF	1041DV
12GK	998GK	135J	A1179J	174D	1064D	22B	R1003M	41DH	1041DE
12GM	998	135K	A1179K	174E	1069-5X	22B1	1001BH	41F	SC1041R
12GST	998GST	135L	A1179L	174F	1069FN	22B2	1001DH	41FM	1041FM
12LA	998LA	135M	760	174H	1069-5Y	22BM	1001BM	41G	1041G
12LB	998LB	135N	A1179N	174HM	1069-5Z	22C1	1001C1	41GA	1041GA
12LC	998LC	135P	A1179P	174J	1069N	22C2	1001C2	41GB	1041GB
12LD	998LD	135R	A1179R	174K	1069G	22CL	X1000GR	41GR	1041GR
12LE	998LE	135S	A1179S	174KM	1069M	22CM	1001CM	41H	1041H
12LF	998LF	135T	A1179T	174P	N1069B	22D1	1001D1	41HN	1041HM
12LG	998LG	135U	A1179U	174S	1069T	22D2	1001D2	41J	10438
12LH	998LH	135V	A1179V	175W	1175N	22DM	1001DM	41K	1041K
12LK	998LK	137A	L1137	180E	EX1	22GM	1001ABM	41KA	1043D

CROSS REFERENCE



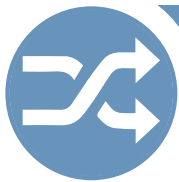

CROSS REFERENCE

TAYLOR

ILCO

TAYLOR

ILCO

TAYLOR

ILCO

TAYLOR

ILCO

TAYLOR

ILCO

41L	S1042Z	49CN	1007CN	57-13N	A1011-13N	61A	1014A	63R	61G
41LB	1043E	49D	1049D	57-15N	A1011-15N	61D	1014D	63S	R63TS
41LS	S10422S	49KM	N1007KMB	57-16N	A1011-16N	61DA	1014DA	63ST	63ST
41LSM	S10422M	49S	1049E	57-17N	A1011-17N	61DB	1014DB	63T	7DC
41N	1041N	501C	79B	57-18N	A1011-18N	61DR	1014DR	63V	63V
41NL	C1041DN	50A	1010A	57-19N	A1011-19N	61DS	1014DS	63W	63W
41P	1041P	50M	1010M	57-1D	1011D1	61DX	1014DX	63Y	G63Y
41PB	1043ED	51S	1010N	57-1H	A1011H1	61F	1014F	64AL	64AL
41R	1041T	51SA	L1010N	57-1N	A1011-1N	61J	1014J	64F	LA6
41RB	1041E	54B1	DXB10	57-20N	A1011-20N	61JS	1014JS	64K	64KK
4 X	1041X	54B2	DXB20	57-21N	A1011-21N	61K	1014K	64I	LA10
41Y	1041Y	54B3	DXB30	57-22N	A1011-22N	61N	O1014S	64LA	LA12
42	1042Z	54C1	DXC10	57-23N	A1011-23N	62A	61NA	64LB	LA11
43A	A1007	54C2	DXC20	57-24N	A1011-24N	62B	62DB	64P	64P
43LA	1007LA	54C3	DXC30	57-25N	A1011-25N	62DC	62DC	64R	64R
43LB	1007LB	54D1	DXD10	57-26N	A1011-26N	62DE	62DE	64S	64S
43LC	1007LC	54D2	DXD20	57-27N	A1011-27N	62DF	62DF	65B	SB5
43LD	1007LD	54D3	DXD30	57-2D	1011D2	62DG	62DG	65CA	65CA
43LDH	1007LDH	54DR	D1054K	57-2H	A1011H2	62DH	62DM	65DL	S62DP
43LDM	1007LDM	54F	1054F	57-2N	A1011-2N	62DHR	R62DM	65F	65FA
43LE	1007LE	54FN	1054FN	57-34D	1011D34	62DJ	62DK	65G	656
43LF	1007LF	54K	1054K	57-3D	1011D3	62DK	62DO	65K	65K
43LG	1007LG	54KD	1054KD	57-3H	A1011H3	62DL	62DP	65M	65M
43LH	1007LH	54KE	A1054KD	57-3N	A1011-3N	62DM	62DH	65TA	65TA
43LHM	1007LHM	54KL	1004KL	57-41D	1011D41	62DN	62DN	65V	V61A
43LJ	1007LJ	54KS	1176	57-4D	1011D4	62E	1069E	66A	A1015C
43LK	1007LK	54KT	1176D	57-4N	A1011-4N	62F	1069FNA	67M	1015M
43LL	1007LL	54LB	1054LB	57-5H	A1011H5	62H	1069HN	68N	1016N
43LM	1007LM	54MT	1054MT	57-5N	A1011-5N	62HA	62HA	68NB	1016NB
43RA	1007RA	54P	1054P	57-6H	A1011H6	62HB	62HB	6PA	997PA
43RB	1007RB	54TW	1054TW	57-6N	A1011-6N	62HO	62JB	71A	1071A
43RC	1007RC	54WA	A1054WB	57-7H	A1011H7	62K	N63G	718	10718
43RE	1007RE	54WB	L1054WB	57-7N	A1011-7N	62KE	VAE1	72A	1017A
43RF	1007RF	54WC	1054WB	57-8H	A1011H8	62KR	SM4	72S	10178
43RG	1007RG	54WC	N1054WB	57-8N	A1011-8N	62L	62L	72SA	1017BA
43RJ	1007RJ	55-10K	1011K10	57-9N	A1011-9N	62LG	62LG	73BM	1074BM
43RJ	1007RJ	55-11K	1011K11	57M	1011PZ	62R	R62Z	73C	SLA16
43RK	1007RK	55-12K	1011K12	57MA	A1011PZ	62RS	62RS	73D	SLA17
43RL	1007RL	55-13K	1011K13	57MK	1011GJ	62S	62Z	73E	1074E
44A	1041WC	55-1K	1011K1	57P	N1011P	62T	62R	73EM	S1073DF
47S	L1042A	55-2K	1011K2	57PA	A1011P	62VA	62VA	73F	1074F
48A	A1008A	55-3K	1011K3	57R	1011GH	62VB	62VW	73N	1074N
48KMR	N1007RMB	55-4K	1011K4	57SA	A1011S	62VC	62VC	75A	1019A
48M	1009M	55-5K	1011K5	57T	N1011T	62VE	62VE	75D	1019D
49CA	1007CA	55-6K	1011K6	57TA	A1011T	62VG	62VG	765D	1028
49CB	1007CB	55-7K	1011K7	58A	SY1	62VM	61N	77A	1047CL
49CC	1007CC	55-8K	1011K8	58AA	SY5-NS	62VO	62VO	79HK	1079B
49CD	1007CD	55-9K	1011K9	58B	SY2	63B	63BG	7DA	997DA
49CE	1007CE	55A	1011A	58BA	SY6-NS	63C	61NC	7E	997E
49CF	1007CF	558	1011B	58C	SY7	63E	63E	7EB	997EB
49CG	1007CG	55M	1011M	58CA	SY3-NS	63G	H62VG	7ER	997ER
49CH	1007CH	55P	1011P	58D	SY4	63GK	SB3	7JA	997JA
49CF	1007CF	55PAA	1011PAA	58DA	SY8-NS	63H	R62VN	7JB	997JB
49CG	1007CG	55S	1011S	58MK	1011MK	63J	63J	7JC	997JC
49CH	1007CH	56DM	1012DM	5JA	S7JA	63JA	63JA	7JD	997JD
49CJ	1007CJ	57-10N	A1011-10N	60BF	1013BF	63K	63K	7JE	997JE
49CK	1007CK	57-11N	A1011-11N	60C	1060C	63L	63LL	7JF	997JF
49CL	1007CL	57-12D	1011D12	60DL	1013DL	63N	RE61N	7JG	997JG
49CM	1007CM	57-12N	A1011-12N	60F	1013F	63P	V61S	7JH	997JH



TAYLOR	ILCO	TAYLOR	ILCO	TAYLOR	ILCO	TAYLOR	ILCO	TAYLOR	ILCO
7JM	J997M	A22B2	A1001DH	A67M	A1015M	B66C	H61G		
7NX	O1122	A22BM	A1001BM	A67MA	L1015M	B66D	SP5		
7x	997X	A22C1	A1001C1	A67N	A1015N	B69D	NE5		
92B	1092B	A22C2	A1001C2	A67P	A1015P	B69K	SR61N	TAYLOR	ILCO
92C	1092C	A22CM	A1001CM	A67Q	A1015Q	B71F	VW1CZ	D68A	DH1
92D	1092DD	A22D1	A1001D1	A67R	A1015R	B73T	HF20	D71Z	DT3
92E	1092E	A22D2	A1001D2	A67S	A1015S	B76L	X62VK	D72D	D72D
92F	1092DS	A22DM	A1001DM	A67T	A1015T	B77U	WT3	D72P	HR62VK
92G	1092D	A22GM	A1001ABM	A67U	A1015U	B79K	SR1	D72R	L62VB
92H	1092J	A22HM	A1001CDM	A67V	A1015V	B79L	SR2	D72S	H62VK
92N	1092N	A22Z2	A1001EH	A67W	A1015W	B80N	HF18	D72T	LR62VB
92NR	1092NR	A43LA	L1007LA	A67X	A1015X	B80NR	BMW1	D72U	OP60C
92T	1092H	A43LB	L1007LB	A67Y	A1015Y	B96K	EB1096K	D72Z	D72Z
92V	1092VA	A43LC	L1007LC	A68V	BIL1	C115	1181C	D73A	DT8
92VR	1092VR	A43LD	L1007LD	A72BL	A1017BL	C180Y	CS91E	D73V	DT5
96C	1096C	A43LE	L1007LE	A72NL	01017NX	CI 84E	R62CA	D73W	DT4
96D	LC3	A43LF	L1007LF	A72VL	01017VX	C199P	1764P	D74E	DT6
96E	LC4	A43LG	L1007LG	A72WL	01017WX	C199S	1764S	D74F	DT1
96F	LC5	A43LH	L1007LH	A73B	A1074B	C21EF	R1001EF	D76F	DT7
96FL	S1096FL	A43LJ	L1007LJ	A73E	A1074E	C21EM	R1001EM	D79V	DT9
96FM	S1096FM	A43LK	L1007LK	A73F	A1074F	C21FM	1001ES	D79W	DT10
96FR	LC5R	A43LL	L1007LL	A73G	A1074G	C21HN	1001GB	D79X	DT11
96FS	1096FS	A43LM	L1007LM	A75M	A1019M	C39A	CH3	D79Y	DT12
96G	S1096G	A49CA	L1007CA	A80M	KL1	C39B	CH4	D80D	DT13
96L	1096L	A49CB	L1007CB	A81L	PO7	C39C	CH5	D80E	DT14
96LN	C1096LN	A49CC	L1007CC	A81M	PO5	C39D	CH6	D80F	DT15
96P	S1096P	A49CD	L1007CD	A81N	A81N	C39E	CH7	D80G	DT16
98DB	1098DB	A49CE	L1007CE	A81P	WT5	C39G	CH8	D80K	DA20
98L	1098L	A49CF	L1007CF	A81R	PA5	C41RB	1096EN	E14	999N
98M	1098M	A49CG	L1007CG	A81S	PA6	C42A	C1041A	E54C	1154C
98x	1098X	A49CH	L1007CH	A96C	L1096CN	C42B	1041TR	F41A	101AM
98XL	1098NR	A49CJ	L1007CJ	B21EF	R1001EE	C42C	C1041J	F41B	102AM
99A	1970AM	A49CK	L1007CK	B21EG	1001MA	C42D	C1041L	F41C	103AM
99B	S1970AM	A49CL	L1007CL	B21EH	1001MB	C42E	C1041N	F41E	104AM
A114A	FL1	A49CM	L1007LJ	B21EM	R1001EM	C42F	SC1041YR	F41M	100AM
A114B	FL2	A49CN	L1007LK	B21EP	R1001 EK	C42G	SC1041S	F54	1054WC
A114C	FL5	A49KM	N1007KMC	B21FK	A1001MJ	C42H	C1041JB	F54A	A1054WC
A114D	FL3	A54-B1	DXB1	B21HP	A1001HP	C42K	SC1041SR	F54F	1054WF
A114E	FL4	A54-B2	DXB2	B22A1	L1001AH	C42L	C1041P	F54FA	A1054WF
A114F	FL6	A54-B3	DXB3	B22A2	L1001FH	C66F	62UC	F54G	1054WD
A114G	FL7	A54-BM	DXB4	B22AM	L1001AM	C66G	R62UC	F54GA	A1054WD
A114H	FL8	A54-C1	DXC1	82231	L1001BH	C80X	L62UC	F54H	1054WH
A114J	FL9	A54-C2	DXC2	B22B2	L1001DH	C81H	VC26	F54HA	A1054WH
A114M	FL10	A54-C3	DXC3	B22BM	L1001BM	D127M	1127DU	F54J	1054WJ
A170CB	A1170CB	A54-CM	DXC4	B22C1	L1001C1	D13GA	H998GA	F54JA	A1054WJ
A170CC	A1170C	A54-D1	DXD1	B22C2	L1001C2	D13GB	H998GB	F54K	1054WK
A170CD	A1170D	A54-D2	DXD2	B22CM	L1001CM	D13GC	H998GC	F54KA	A1054WK
A170CF	1170CJ	A54-D3	DXD3	B22D1	L1001D1	D13GD	H998GD	F54L	1054WL
A190	A190	A54-DM	DXD4	B22D2	L1001D2	D13GE	H998GE	F54LA	A1054WL
A191	AG2	A54DR	D1054KA	B22DM	L1001DM	D13GF	H998GF	F54N	1054WN
A192	A192	A54-GM	DXG5	B22GM	L1001ABM	D13GG	H998GG	F54NA	A1054WN
A21EF	A1001MF	A57-12D	A1011D12	B22HM	L1001CBM	D13GH	H998GH	F54P	1054WP
A21EH	A1001MB	A57-1D	A1011D1	B57-12D	B1011D12	D13GK	H998GK	F54PA	A1054WP
A21EJ	1001EJ	A57-2D	A1011D2	B57-1D	B1011D1	D180X	64D	F54R	1054WR
A21HN	1001GA	A57-34D	A1011D34	B57-2D	B1011D2	D54F	L1054F	F54RA	A1054WR
A22A1	A1001AH	A57-3D	A1011D3	B57-34D	B1011D34	D66J	XD63	F66A	F38
A22A2	A1001FH	A57-41D	A1011D41	B57-3D	B1011D3	D66T	63H	F66C	F66C
A22AM	A1001AM	A57-4D	A1011D4	B57-41D	B1011D41	D67N	R62PE	F66D	F41
A22B1	A1001BH	A67L	A1015L	B57-4D	B1011D4	D67P	R61N	F68B	GT2



CROSS REFERENCE



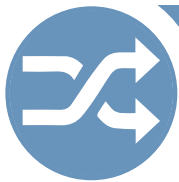

CROSS REFERENCE

	TAYLOR	ILCO	TAYLOR	ILCO	TAYLOR	ILCO	TAYLOR	ILCO
	H199M	H199N	H80-5	HD32	M63E	1463E	O43LL	O1007LL
	H200	GP1125	H80-6	HD33	M67K	H63M	O43LM	O1007LM
	H54B	H1054B	H80-7	HD34	M67L	HR62VG	O43RA	O1007RA
	H54S	H1054S	H80-8	HD35	M68	MB59	O43RB	O1007RB
	H69T	SR67K	H80A	HD7	M68E	63C	O43RC	O1007RC
	H69TR	S67K	H98DB	H1098DB	M68F	YM1	O43RE	O1007RE
	H69U	H67K	H98L	H1098L	M68G	YM4	O43RF	O1007RF
	H69UR	UR67K	H98LA	H1098LA	M68H	63TV	O43RG	O1007RG
	H69V	HD3	H98M	H1098M	M68J	YM3	O43RJ	O1007RJ
	H69W	HD2	H98X	H1098X	M68T	RE61XR	O43RK	O1007RK
	H69X	HD1	H98XL	H1098NR	M70R	HF1	O43RL	O1007RL
	H70H	R67K	HF38	HF38	M72F	M72F	O48	O1009
	H70J	HD24	HF43	HF43	M73J	HF14	O48KMRN	1007RMA
	H70K	67J	HHI	HH1	M73K	HF3	O49CA	O1007CA
	H70V	HO61D	HNI	HN1	M73L	HF15	O49CB	O1007CB
	H70W	HO61E	HRO7NX	H1122AR	M73M	HF16	O49CC	O1007CC
	H70X	H70X	J41	1046	M73N	HF9	O49CD	O1007CD
	H70Z	H70Z	J41A	1046A	M79S	MB18	O49CE	O1007CE
	H71L	HD25	J66M	J66M	M79T	MB15	O49CF	O1007CF
	H71T	67H	J81J	KL2	M79U	MB16	O49CG	O1007CG
	H72G	H72G	K22	1001GH	M79UR	MB16R	O49CH	O1007CH
	H72H	H72H	K22MK	1001MK	M81G	MG1	O49CJ	O1007CJ
	H73Z	H73Z	K77L	K77L	M81X	MB17	O49CK	O1007CK
	H74L	E67K	K81D	LF7	N102	1177N	O49CL	O1007CL
	H74M	HD22	K924	K924	N174D	R1064E	O49CM	O1007CM
	H76G	H76G	K926	K926	N20	1083	O49CN	O1007CN
	H76H	HD13	L191	LF10	N20C	1083C	O49CR	O1007CR
	H76J	HD14	L191A	VR91	N20H	1083H	O49KM	N1007KMA
	H76K	HD11	L191B	LF6	N20J	1083J	O49N8	O07NB
	H76V	HD17	L192	LF5	N20K	1083K	O50	1010U
	H76VR	HD9	L192M	L192M	N20L	1083L	O50A	A1010U
	H76W	HD12	L193	LF14	N20M	1083M	O54	O1054
	H76WR	HD10	L194	L194	N20N	1083N	O63	FV1
	H76X	H76X	L199K	D1707K	N20P	1083P	O67S	62PE
	H76Y	HD4	L199M	1705K	N20R	1083R	O67T	L62VJ
	H76YR	HD18	L20KC	X1001 KC	N20S	1083S	O71V	L62VN
	H76Z	HD16	L53	1004L	N20T	1083T	O72A	62PG
	H76ZR	HD6	L54B	L1054B	NE13	NE13	O72BL	1017BL
	H77E	HD20	L54G	L1054G	NE15	NE15	O72NL	O1017NL
	H77ER	HD19	L54J	K1054B	NE26	NE26	O72WL	O1017WL
	H77P	H77P	154K	K1122B	NE7	NE7	O73E	62PF
	H77PR	H77PR	L54L	K1122C	O102	O1022	O73F	62PD
	H77R	U67K	L54M	L1054M	O102A	O1022AB	O73G	R62PD
	H77RR	U67KR	L54N	K1122N	O1S	O1S	O73H	R62PF
	H78H	HD5	L54P	K1122D	O20F	XO1000F	O73R	R62PG
	H78HR	HD5R	156K	X1011KR	O20G	O1000GX	O76P	62PH
	H78KR	H78KR	L67A	GT1	O43LA	O1007LA	O76R	OP11
	H79C	HD42	L67V	LR62VA	O43LB	O1007LB	O77J	UR62VP
	H79CR	HD43	L69L	LA5	O43LC	O1007LC	O77S	YM6
	H79M	H79M	L70L	LA14	O43LD	O1007LD	O77T	YM7
	H79MR	H79MR	L70M	LA4	O43LDH	O1007LDH	O79F	YM8
	H7F	H1122F	L70N	LA13	O43LDM	O1007LDM	O79G	YM9
	H7FR	H1122FR	LF13	LF13	O43LE	O1007LE	O79JB	O79JB
	H7W	H1122W	LM1	LM1	O43LF	O1007LF	O79JC	O79JC
	H80	HD8	LM2	RT19	O43LG	O1007LG	O79JD	O79JD
	H80-1	HD29	LO7NX	L1122A	O43LH	O1007LH	O79JE	O79JE
	H80-2	HD23	LR191A	VR91R	O43LHM	O1007LHM	O7B	O1122B
	H80-3	HD30	M174	1064M	O43LJ	O1007LJ	O7BR	O1122BR
	H80-4	HD31	M63B	M63BG	O43LK	O1007LK	O7C	O1122C





TAYLOR	ILCO	TAYLOR	ILCO	TAYLOR	ILCO	TAYLOR	ILCO	TAYLOR	ILCO
O7E	O997E	R63K	R63K	S42	S42	T146	1270D		
O7G	O997G	R63R	R61G	S50	70S	T147	1147		
O7NV	O1122NV	R63S	R63ST	S51	170S	T148	1148		
O7NX	O1122A	R63ST	63TS	S54E	SY9	T153	T153	TAYLOR	ILCO
O988	O1098B	R63V	R63V	S64S	BR6	T180K	TK1	T74U	TA5
O98D	O1098D	R63W	R63W	S66L	AS41	T21	O1225N	T74V	TA16
O98H	S1098H	R63Y	63Y	S67C	R61P	T22	1417	T74W	TA11
O98K	S1098K	R64F	LA7	S67D	61P	T23	1270C	T74X	TA12
O98LA	O1098LA	R64T	BR7	S67E	61PC	T25	1225PL	T74Y	TA2
P102	SC1176	R65F	R65FA	S67G	S65CA	T26	1242L	T74Z	TA4
P19	1768CH	R65G	R65G	S68SK	SB2	T26S	1033A	T75	T75
P19A	P1770U	R67M	A1015MR	S70U	SB1	T27	1303	T77	T77
P27	1167FD	R67Q	A1015QR	S71B	62FS	T28	T28	T77ZL	H62DP
P27E	1181FD	R67R	A1015RR	S71W	63L	T30	611	T78L	TA8
P27FD	1127FD	R67S	A1015SR	S71X	SB4	T31	1332S	T78M	TR18
P64E	R62BZ	R67T	A1015TR	S71Y	U62VA	T32	O1215	T79P	HF23
P64H	P64H	R67U	A1015UR	S72J	61PS	T33	1286E	T79PR	HF22
P65A	P65A	R67V	A1015VR	S73	SLA15	T34	1214	T79R	HR62FD
P65C	P65C	R67W	A1015WR	S74G	SUZ1	T35	R1286E	T80	T80
P66E	P66E	R67Y	A1015YR	S74H	SUZ2	T37L	T37L	T80J	T80J
P67F	63P	R68W	HR62DG	S74J	SUZ4	T38	1222L	T80S	T61D
P68Z	64K	R79N	H61SB	S74K	SUZ3	T39	T39	T80U	T61E
P69A	DM4	R7NX	O1122R	S76S	NE19	T40	T40	T80V	T61F
P69B	62VB	R80B	R80B	S77Y	SZ1	T41	T41	T80W	SR4
P69C	U63H	R80C	NE14	S7AH	1122D	T42	1221L	T81A	TR25
P69Y	DM2	R81F	R81F	S80L	61PE	T42A	O1221L	T81B	TR26
P70C	63VO	RA21HN	R1001GA	S91B	S1098B	T44	T44	T83	1416
P72	DM3	RA22A1	1001A1	S91D	S1098D	T45	T45	T84	816A
P73U	63PX	RA22A2	1001A2	S96	170S6	T46	T46	T86	T86
P73X	H64E	RB21FK	A1001MJR	S96B	S1096B	T49	149	T88	T88
P79A	KP1	RB21FM	R1001ET	SA47	1047	T50	T50	T89	T89
P79B	P79B	RC21FM	R1001ES	T100	SLA12	T51A	1225BL	T92	T92
P91A	P1098A	RM63E	MR63E	T101	SLA13	T53	1213A	T93L	1270
P91C	P1098C	RO102	1022HR	T104	1233M	T54	610BL	T95	T95
R102	1022L	RO102A	1022H	T104A	633MH	T54A	610B	T96	T96
R102A	R1022L	RO7NX	O1122AR	T105	T105	T55	1224L	T97	T97
R174B	R1069L	RS180V	SW4R	T107	T107	T55A	1224	TS149	TS149
R174D	R1064D	S145CE	1145CE	1108	N1286R	T55B	1224F	TS150	TS150
R185V	R185V	S145EF	1145EF	T109	1286B	T57	2714	U180F	1033N
R185VS	VR91A	S145FG	1145FG	T111	1286	T60	T60	U180G	U180G
R191B	VR91BR	S174	1069S	T112	687W	T61	O1223	U92A	1092V
R191C	VR91C	S174K	S1069G	T113	1239	T61L	O1223L	V20S	S1000XK
R20HL	R1000HL	S174L	N1069J	T114	632M	T62DL	B62DP	V41	1043V
R20T	R1000T	S174M	1069SM	T115	621A	T62L	1225	V66P	U62VB
R20TS	SR1000T	S174S	S1069T	T115L	1221AL	T63	1412	V67	U62VN
R20V	R1000V	S179U	SW3	T116	1215B	T64	T64	V68D	61VW
R21EG	R1001EG	S180L	ME1	T120	1427	T66	672	V68K	W62VE
R21EL	R1001EL	S180U	SW1	T121	N1286	T66U	TP1	V68L	V61VW
R21EN	R1001EN	S180UR	S180UR	T122	1286BR	T66V	TP2	V68LR	U61VW
R40C	R1040C	S180V	SW4	T123	1286C	T66W	TP3	V69N	VW63
R40E	R1040E	S180W	S180W	T124	T124	T66X	TP6	V69P	VW63A
R41DC	R1041DC	S180Z	SW2	T125	616	T66Y	TP5	V70A	VL1
R41DF	R1041DV	S181	S170S1	T126	T127	T66Z	TP4	V70D	HF17
R41F	SC1041TR	S19	S1770U	T127	666	T69R	TA6	V70E	63VR
R61DA	A1014DR	S191A	VR91S	T131	T131	T70	T70	V71E	S62DW
R62P	SM7	S199L	1766S	T132	1225G	T72	T72	V72B	VW64
R62VB	R62VB	S27	S1167FD	T139	T139	T72C	62FE	V72E	V72E
R62Y	61H	S27E	S1181FD	T141	687Y	T73	T73	V72L	VW64T
R63E	R63E	S27FD	S1127FD	T142	687X	T74	T74	V72N	V72N



CROSS REFERENCE



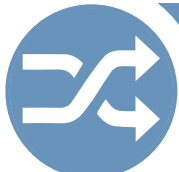

TAYLOR

V76T
V77
V77M
V77V
V78G
V78J
V78JK
V79D
V80P
V81V
V81W
VR1
VR1R
W180M
W77D
W90
WA1
WA2
WS11
X1
X10
X100
X101
X102
X103
X104
X105
X106
X107
X108
X109
X11
X110
X111
X112
X113
X114
X115
X116
X117
X118
X119
X12
X120
X121
X122
X123
X124
X125
X126
X127
X129
X13
X130
X131

ILCO

H62DR
VO6
BR9
VW77
VW67S
VW67
V27
VO62
V80P
VW71A
VW71
VR1
VR1R
62RG
WS5
W67
WA1
WA2
WS11
X1
X10
X100
X101
X102
X103
X104
X105
X106
X107
X108
X109
X11
X110
X111
X112
X113
X114
X115
X116
X117
X118
X119
X12
X120
X121
X122
X123
X124
X125
X126
X127
X129
X13
X130
X131

X132
X133
X134
X135
X136
X137
X138
X139
X14
X140
X141
X142
X143
X144
X145
X146
X147
X148
X14S
X14SS
X150
X151
X152
X153
X154
X155
X156
X16
X17
X18
X19
X199G
X2
X20
X20F
X20FR
X21
X22
X23
X24
X25
X26
X27
X28
X29
X3
X30
X31
X32
X33
X34
X35
X36
X37
X38
X39
X4
X40
X41

X132
X133
X134
X135
X136
X137
X138
X139
X14
X140
X141
X142
X143
X144
X145
X146
X147
X148
X14S
X14SS
X150
X151
X152
X153
X154
X155
X156
X16
X17
X18
X19
X199G
X2
X20
X200F
X1000FR
X21
X22
X23
X24
X25
X26
X27
X28
X29
X3
X30
X31
X32
X33
X34
X35
X36
X37
X38
X39
X4
X40
X41

X42
X43
X44
X45
X46
X48
X49
X5
X50
X51
X52
X53
X54
X54F
X54K
X54W
X55
X56
X57
X58
X59
X6
X60
X61
X61F
X61FR
X62
X63
X64
X65
X66
X67
X68
X69
X7
X70
X71
X72
X73
X74
X75
X76
X77
X78
X79
X8
X80
X81
X82
X83
X84
X85
X86
X87
X88
X89
X9
X90
X91

X42
X43
X44
X45
X46
X48
X49
X5
X50
X51
X52
X53
X54
X1054F
X1054K
X1054WA
X55
X56
X57
X58
X59
X6
X60
X61
X1014F
1014C
X62
X63
X64
X65
X66
X67
X68
X69
X7
X70
X71
X72
X73
X74
X75
X76
X77
X78
X79
X8
X80
X81
X82
X83
X84
X85
X86
X87
X88
X89
X9
X90
X91

X92
X93
X94
X95
X96
X97
X98
X98A
X98C
X98E
X98J
X99
XL16
XL17
XO199G
XO199L
XO199R
Y174A
Y68M
Y68N
Y68P
Y71H
Y71J
Y71N
Y71P
Y73C
Y73D
Y73Y
Y76B
Y76C
Y77B
Y77F
Y77G
Y77K
Y80T
Y80TR
Z180N
Z185
Z185B
Z185C
Z185D
Z185E
Z186A
Z186B
Z186C
Z186D
Z186E

X92
X93
X94
X95
X96
X97
X98
H1098A
H1098C
P1098E
P1098J
X99
1180S
1182
XO1199G
1701G
1759P
1069YM
YH1
YH2
YH12
Y71H
YH10
YH4
YH3
YH14
YH17
YH13
Y76B
Y76C
Y77B
YH6
YH9
YH7
YH20
YH16
ZKN1
S60
60HA
60HB
60Z7
60ZD
60UA
6023
R60ZD
60UF
60UG

WESLOCK
WESLOCK
12344
WILSON-BOHANNAN
WIL-BOHAN
19
20A
20B
20C
20M
21A
21B
21C
21M
22A
XL LOCK
XL LOCK
XL7
XL5
YALE
YALE
87
88
88
4551
4553
9826
1017B10L
1017B10L
1036B10L
12 1/2E3L
12 1/2E3R
12 1/2JA
12 1/2JB
12 1/2JC
12 1/2JD
12 1/2JE
12 1/2JF
12 1/2JG
12 1/2JH
12 1/2JK
12 1/2JMK
19E1R
24 1/2E8R
24 1/2E8R
421B10R
423F8R
768C-C5R
9278B10R
9E1R
E1019B10L
E1019B10L
E1019B10R
E1019B10R
E1019F8L
E1019F9L
E1019F9R
E10E3L
E10E3R

ILCO
ILCO
1175
1175N
ILCO
WB19
1071B
1071BD
1071BE
1071BM
1071
1071D
1071E
1071M
1071A
ILCO
1180S
1182
ILCO
2N
1
1N
O1122B
O1122C
1122D
F1122AR
H1122FR
L1122AR
O997ER
O997E
997JA
997JB
997JC
997JD
997JE
997JF
997JG
997JH
997JK
J997M
SX9B
1132
H1132
L1122A
L1122B
889A
O1122A
999B
H1122AR
O1122AR
H122A
E1122A
O1122BR
O1122BER
O1122BE
R997EB
997B





YALE	ILCO	YALE	ILCO	YALE	ILCO
E10E3R	997EB	EN11SC	998SC	EN8VE	999VE
E10E3R	B997EH	EN11SD	998SD	EN8VG	999VG
E11E1R	999A	EN11SE	998SE	EN8VH	999VH
E13E3L	997ER	EN11SF	998SF	EN9LH	998LH
E13E3L	H997ER	EN11SG	998SG	FN411GA	D998GA
E13E3R	YL1	EN11SH	998SH	FN411GA	H998GA
E13E3R	Y200	EN11SK	998SK	FN411GA	999GB
E13E3R	997D	EN11SMK	998SMK	FN411GB	D998GB
E13E3R	997E	EN11TA	998TA	FN411GB	H998GB
E13E3R	H997E	EN11TB	998TB	FN411GC	D998GC
E8E1L	999R	EN11TC	998TC	FN411GC	H998GC
E8E1L	H999R	EN11TD	998TD	FN411GD	D998GD
E8E1R	999	EN11TE	998TE	FN411GD	H998GD
E8E1R	999N	EN11TF	998TF	FN411GE	D998GE
E8E1R	999U	EN11TG	998TG	FN411GE	H998GE
E8E1R	H999	EN11TH	998TH	FN411GF	D998GF
E8E1R	X999	EN11TK	998TK	FN411GF	H998GF
E9810B10R	H1122W	EN11TMK	998TMK	FN411GG	D998GG
EB25E8L	HR1132	EN11VA	998VA	FN411GG	H998GG
EB25E8L	R1132	EN11VB	998VB	FN411GH	D998GH
EN10JA	S7JA	EN11VC	998VC	FN411GH	H998GH
EN10JMK	997GX	EN11VD	998VD	FN411GK	D998GK
EN117GMK	998A	EN11VE	996VE	FN411GK	H998GK
EN117GST	A998GST	EN11VF	998VF	FN411GMK	H998
EN11C1L	994ARM	EN11VG	998VG	FN411VMK	H998R
EN11C1R	994M	EN11VH	998VH	FN41TMK	H998TMK
EN11C4R	Y202	EN11VK	998VK	H7W	1122
EN11C4R	C999	EN11VMK	998R	TA637B10R	01122NV
EN11GA	998GA	EN13JMK	O997G	X10 1/2E3R	997X
EN11GB	998GB	EN27B10R	O997A	X10 1/2E3R	H997EB
EN11GC	998GC	EN27B10R	F1122A		
EN11GD	998GD	EN27B10R	H1122F		
EN11GE	998GE	EN27B10R	NO1122D		
EN11GF	998GF	EN33B10L	R997DA		
EN11GG	998GG	EN33B10R	997DA		
EN11GH	998GH	EN33B10R	997DB		
EN11GK	998GK	EN411E1R	D9		
EN11GLK	998GL	EN8GA	999GA		
EN11GMK	998	EN8GC	999GC		
EN11GST	998GST	EN8GD	999GD		
EN11LA	998LA	EN8GE	999GE		
EN11LB	998LB	EN8GF	999GF		
EN11LC	998LC	EN8GG	999GG		
EN11LD	998LD	EN8GH	999GH		
EN11LE	998LE	EN8GK	999GK		
EN11LF	998LF	EN8GMK	998S		
EN11LG	998LG	EN8LA	999LA		
EN11LK	998LK	EN8LB	999LB		
EN11PA	998PA	EN8LC	999LC		
EN11PB	998PB	EN8LD	999LD		
EN11PC	998PC	EN8LE	999LE		
EN11PD	998PD	EN8LF	999LF		
EN11PE	998PE	EN8LG	999LG		
EN11PF	998PF	EN8LH	999LH		
EN11PG	998PG	EN8LK	999LK		
EN11PH	998PH	EN8VA	999VA		
EN11PK	998PK	EN8VB	999VB		
EN11SA	998SA	EN8VC	999VC		
EN11SB	998SB	EN8VD	999VD		

||||| CROSS REFERENCE |||||



New keys available since our last Key Blank Directory

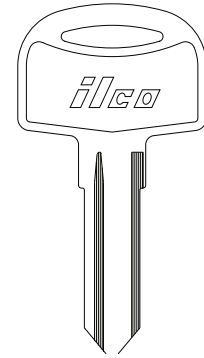
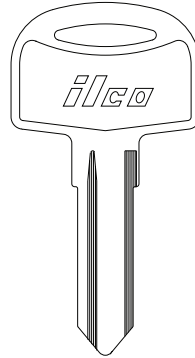
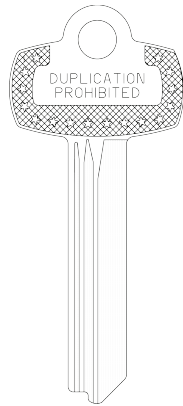
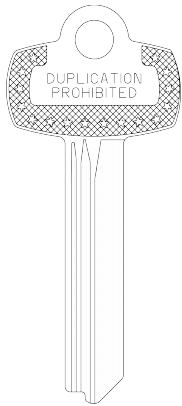

Ilco No.:
EZ No.
Used On:

1A1N1
—
Best

1A1TB1
—
Best

1679
—
Cole Hersee

1679R
—
Cole Hersee

1689
—
Cole Hersee

1689R
—
Cole Hersee

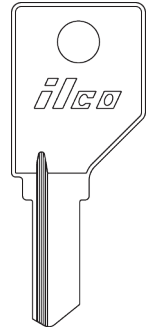
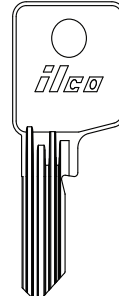
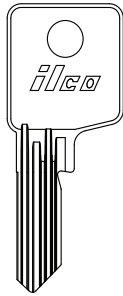
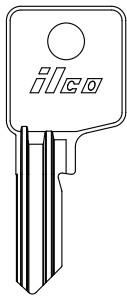

Ilco No.:
EZ No.
Used On:

DM HHS
—
DOM

DM KL
—
DOM

DM VL
—
DOM

1866-DO3
—
DOMINION



A Member of the Kaba Group

Kaba Ilco Corp.

P O Box 2627 (27802)

400 Jeffreys Rd., Rocky Mount, NC 27804

Tel.: (252) 446-3321 • Fax: (252) 446-4702

www.kaba-ilco.com

New keys available since our last Key Blank Directory



Ilco No.:
EZ No.:
Used On:

1677
—
E-Z GO



P1117
HU101
FORD

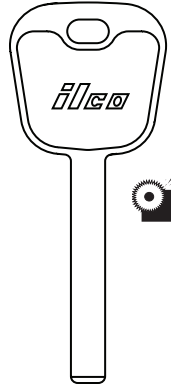

P1116
B119
GENERAL MOTORS

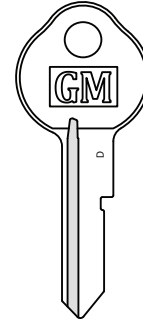

O1098D-GM
—
GENERAL MOTORS

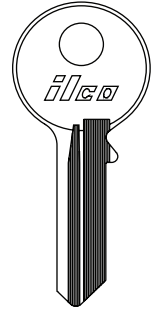

1672
—
GUARD SECURITY

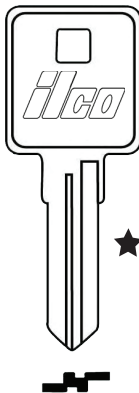

Ilco No.:
EZ No.:
Used On:

X287
HYD15
HARLEY DAVIDSON

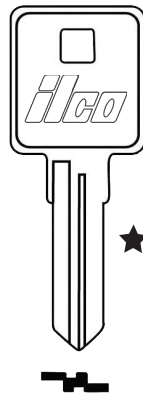

X283
HYD16
HARLEY DAVIDSON



X284
HYD17
HARLEY DAVIDSON

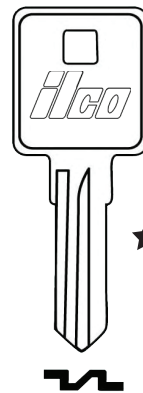

X285
HYD18
HARLEY DAVIDSON



X286
HYD19
HARLEY DAVIDSON

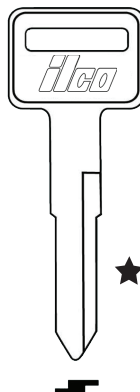

Ilco No.:
EZ No.:
Used On:

X289
HD118
HONDA MOTORCYCLE



X291
HD114
HONDA MOTORCYCLE

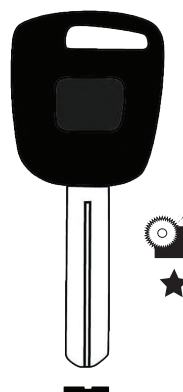

HD117-P
—
HONDA MOTORCYCLE

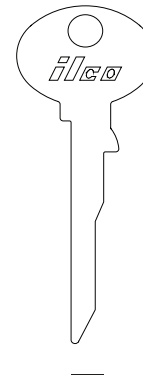

1673
—
HUMANE RESTRAINT

★ Keys Available Soon

Special Key Machine Required

New keys available since our last Key Blank Directory

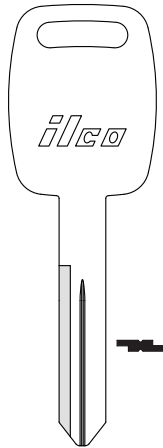

Ilco No.: K1995-B94
EZ No.: B94
Used On: KENWORTH



1687
—
MEDECO PATRIOT

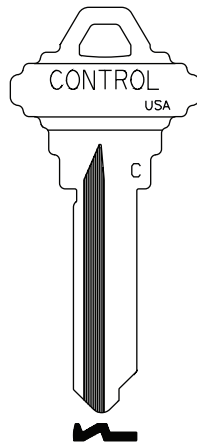

101-C LFIC CONTROL
—
SCHLAGE



101C-BR
—
SCHLAGE

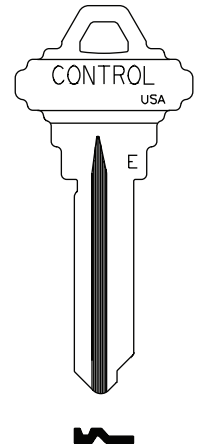

101-E LFIC CONTROL
—
SCHLAGE

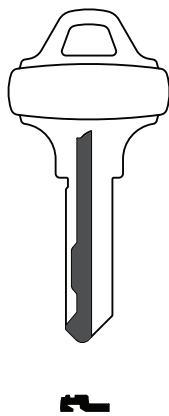

Ilco No.: C123
EZ No.: —
Used On: SCHLAGE

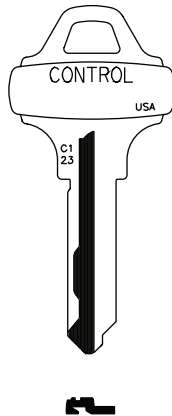

C123 CONTROL
—
SCHLAGE

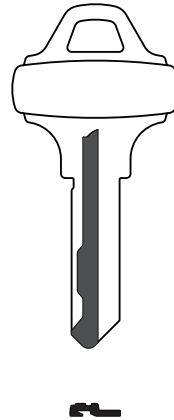

C145
—
SCHLAGE

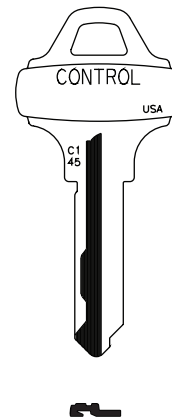

C145 CONTROL
—
SCHLAGE

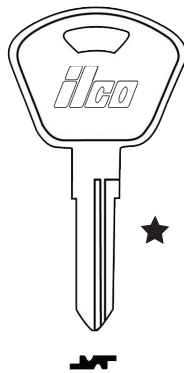

Ilco No.: X288
EZ No.: TMC3
Used On: TRIUMPH MOTORCYCLE

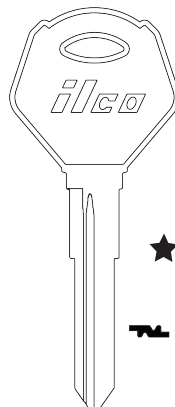

X290
YH65
YAMAHA

★ Keys Available Soon